



# Doing a Feasibility Study

Training Activities for Starting or Reviewing a Small Business

## **Overseas Programming and Training Support**

The Peace Corps Office of Overseas Programming and Training Support (OPATS) develops technical resources to benefit Volunteers, their co-workers, and the larger development community.

This publication was produced by OPATS and is made available through its Knowledge & Learning Unit (KLU), formerly known as Information Collection and Exchange (ICE). Volunteers are encouraged to submit original material to [KLU@peacecorps.gov](mailto:KLU@peacecorps.gov). Such material may be utilized in future training material, becoming part of the Peace Corps' larger contribution to development.

Peace Corps  
Office of Overseas Programming and Training Support  
**Knowledge and Learning**  
1111 20th Street, NW, Sixth Floor  
Washington, DC 20526

[KLU@peacecorps.gov](mailto:KLU@peacecorps.gov)

Abridged Dewey Decimal Classification (DDC) Number: 658.02

# Doing a Feasibility Study:

Training Activities for Starting or Reviewing a Small Business

**EDITOR: SUZANNE KINDERVATTER**

Contributors:

Marcy Kelley

Molly Melching

Maggie Range

Liza Valenzuela

OEF staff and consultants in Central America, Senegal, and Somalia

Poster Story Illustrations: Malick Pouye

Reprinted with permission of  
United Nations Development Fund for Women (UNIFEM)

*June 2013*



Peace Corps

Information Collection and Exchange

Publication No. SB104

## **APPROPRIATE BUSINESS SKILLS FOR THIRD WORLD WOMEN A SERIES EDITED BY SUZANNE KINDERVATTER**

Series editor Suzanne Kindervatter, Ed.D., was OEFs Director of Technical Services, a specialist in non-formal education, and is a noted author of training materials including *Women Working Together for personal, economic and community development*.

Nena Terrell  
Production Supervisor

Patrice Gallagher  
Design

Jacqueline Lucas  
Editorial Assistant

Jim Long  
Illustration

Jerry Beals  
Production

Somali drawings courtesy of OEF - Somalia

Distributed by:  
Women, Ink.  
777 United Nations Plaza  
New York, New York 10017  
Tel: 212-687-8633  
Fax: 212-661-2704

©1987 by OEF International  
©1991 by UNIFEM  
3rd Printing, 1992  
All rights reserved  
Printed in the United States of America

Spanish edition entitled

*Cómo hacer un estudio de factibilidad. Entrenamiento para iniciar o reexaminar una pequeña empresa*

French edition entitled

*Réalisation d'une étude de faisabilité: Activités de formation pour créer ou faire le bilan d'une petite entreprise*

### **Library of Congress Cataloging-In-Publication Data**

Doing a feasibility study.

(Appropriate business skills for Third World women; 2)

Bibliography: p.

1. New business enterprises-Developing countries-Handbooks, manuals, etc.
2. Women-owned business enterprises-Developing countries-Handbooks, manuals, etc. I. Kindervatter, Suzanne. II. OEF International. III. Series.

HD62.5D63 1987 658:022'091724 86-61951 ISBN 0-912917-7-5

# Table of Contents

<b>PREFACE</b> .....	2
<b>A COMMON CHALLENGE</b> .....	3
<b>NOTES TO THE FACILITATOR</b> .....	5
Letting Women Decide: Is This Business Viable? .....	6
Feasibility Study: What It Means .....	7
Chart: Feasibility Study Steps .....	7
What Is in the Manual .....	9
Chart: Training Goals .....	9
Learning by Doing .....	10
<b>PLANNING YOUR PROGRAM</b> .....	11
Who Can Use This Manual .....	12
A Word about Literacy .....	13
Preparing Facilitators to Use the Manual .....	13
Where to Meet .....	14
What Materials to Prepare .....	14
How to Arrange a Schedule .....	15
Chart: Possible Schedules for “Learning the Steps” .....	16
Chart: For Women with Existing Businesses .....	18
Chart: Tips for the Good Facilitator .....	19
My Training Plan .....	20
Activities to Begin and End the Day .....	22
<b>PART ONE: FEASIBILITY STUDIES-LEARNING THE STEPS .....31</b>	
<b>SIX STEPS FOR A FEASIBILITY STUDY</b> .....	30
<b>WHY DO A FEASIBILITY STUDY?</b> .....	31
What Is a Feasibility Study? .....	31
Instructions for Adapting the Story and Posters .....	33
Poster Story .....	34
What We Will Accomplish .....	39
We Can Do It! .....	41
<b>STEP ONE: CHOOSE A PRODUCT OR SERVICE TO SELL</b> .....	43
Exploring Women’s Work .....	44
Things to Consider in Identifying Business Ideas .....	46
Which Business Should We Study? .....	49
<b>STEP TWO: FIND OUT IF PEOPLE WILL BUY OUR PRODUCT OR SERVICE</b> .....	51
Looking at Customer Demand .....	52
Will People Buy What We Plan to Sell? .....	54
<b>STEP THREE: DETERMINE HOW THE BUSINESS WILL OPERATE</b> .....	57
What We Know, What We Need to Find Out .....	58
How Will We Work? .....	60

<b>STEP FOUR: CALCULATE BUSINESS EXPENSES</b> .....	62
Types of Business Costs .....	63
Business Cost Posters .....	65
Finding Examples of Business Costs .....	83
What Do We Need to Buy? How Much Will It Cost? .....	85
<b>STEP FIVE: ESTIMATE SALES INCOME</b> .....	88
Selling a Product or Service .....	89
How Much Can We Sell, and For How Much? .....	93
Price and Competition Posters .....	97
<b>STEP SIX: DECIDE—IS THE BUSINESS A GOOD IDEA?</b> .....	101
How to Calculate Profit and Cash Flow .....	102
What Will Our Profit Be? .....	107
What Other Benefits Are Important? .....	109
Is the Business a Good Idea? .....	110

## **PART TWO: DOING A FEASIBILITY STUDY..... 111**

<b>TIPS FOR THE FACILITATOR</b> .....	112
Helping Them Help Themselves .....	113
Setting the Schedule .....	114
Holding Meetings During the Study .....	115
Making the Meetings Interesting .....	115
If the Women Miss a Meeting .....	116
Recording the Information .....	116
Feasibility Study Information Form .....	117
<b>GETTING THE INFORMATION WE NEED</b> .....	119
Selecting a Business to Study .....	120
Why Planning Is Important .....	121
Planning Our Feasibility Study .....	122
Gathering Information from “Experts” .....	124
<b>DECIDING ON OUR BUSINESS</b> .....	125
To the Facilitator .....	126
Business Plan Forms .....	127
Making Our Business Plan .....	137
Determining Cash Needs to Start the Business .....	138
Investment Plan Forms .....	139
Determining Cash Needs to Operate the Business .....	141
Notes on Cash Flow Analysis .....	143
Making Jelly in Costa Rica Story .....	144
Should We Pursue This Business? .....	148
Decision-Making Checklist .....	148
Business Start-Up: First Steps .....	149
<b>POSTER STORY ILLUSTRATIONS</b> .....	151

# Preface

Throughout the development community, there is now widespread recognition of the vital contribution small business makes to local and national economies. At the same time, there is a concern that many attempts at assisting small business development have failed. Development professionals, from economists in the World Bank to trainers in local organizations, are asking: what is effective small enterprise development? how do we do it?

The “how to’s” of developing small business have been a major priority for OEF International for over a decade. In this first manual of our “Appropriate Business Skills for Third World Women” series, we address the “how to” of identifying and planning an economically viable business.

Visiting OEF projects in Africa and Central America, I have been struck by women’s dire need and high motivation to pursue business activities. And, I have been impressed at how they are able to use business concepts that they have learned in training. In one case, women entrepreneurs first thought of tie-dyeing as a good income-generating activity, but after applying the feasibility study to different options, it was clear that a soap-making business would be the most profitable. Today, they have a successful soap-making operation. In another case, one woman in Senegal told of how she helped her husband do a feasibility study on raising and selling a cow. She said that he had not included the price of food and care for the cow before setting the sales price. He initially told her that this was of no importance. However, after she did the calculations for him and explained how much he had originally invested, plus spent on care, he realized he would not make a profit if he did not raise his price!

This manual is built on the experience of women like these and the staff of local organizations that assist them. We are proud to make it available to those who are working at the “front-line” of small business development, trainers and programmers who work with Third World women and understand their needs, as well as their hopes.

*Elise S. Smith*

OEF International



# A Common Challenge

Over the past ten years, OEF International has assisted women throughout the Third World who want to start or improve small businesses. In Africa, Asia, and Latin America, we have again and again met the same challenge. Women often choose businesses with limited market viability, because these businesses are most familiar and use skills the women already have. Small business is a risky undertaking, and the kind of businesses women tend to choose make it more risky for them.

To confront this common challenge, OEF International has emphasized the importance of examining various business options and carefully determining whether a particular option is economically feasible. This manual represents our cumulative experience in enabling women to do just that.

The conceptual design and training activities in the manual grew out of three years of work in Peru, Central America, West Africa, and Somalia. Everyone who contributed to the manual has been guided by the principal, "simple but efficient." In other words, we have worked hard to make the business concepts understandable to illiterate or minimally literate women; but at the same time, we have recognized that certain financial calculations are essential for determining business viability. The manual uses "visual association" to help the women learn and remember business concepts. This means that concepts are presented in association with pictures or symbols, and are repeated again and again throughout the program.

This manual is a product of a true collective effort. Sincere thanks and appreciation go to the following people for their invaluable contribution to "Doing a Feasibility Study."

Marcy Kelley, for the original conceptualization of the feasibility study;

Molly Melching and Malick Pouye, creators of the brilliant poster story from Senegal;

Maggie Range, who helped put complex business concepts into participatory learning activities;

Liza Valenzuela, for help with business concepts and organizing the steps;

Anne-Laurence Dodge, designer of the "Selling Candy" activity in Step Six;



Merryl Rosenblatt, for “Making Jelly in Costa Rica” and assistance with financial calculations;

To the team of trainers in Senegal, who used the materials and provided ideas on how to improve them - OEF staff members Soukeyna Ba N’Diaye and Debbie Fredo and staff of the Maisons Familiales Rurales, Famara Dedhiou (Director), Clement Faye (Regional Director), Amadou Cisse - Sarru (Regional Coordinator), Dada N’Diaye (trainer), Alpha Badji (trainer), and Madjiguene Diaw Saar (trainer);

To OEF staff in Costa Rica, El Salvador, and Honduras, for their careful and critical analysis of needed revisions in the manual - Flory Meza, Patricia Rodriguez, Iris Villalobos, Beatriz Coto, Rosemary Coto, Maria Eugenia Antunez, Blanca Canales, Rosibel Gomez, Dinorah de Sanchez, and Peace Corps volunteers Luz Iraida Diaz and Kim Stuntz;

To the members of The Somali Women’s Democratic Organization (SWDO), who provided a real test of the manual’s appropriateness for illiterate women with no business experience.

To the trainers in Peru, who helped develop some of the original concepts;

To U.S. taxpayers and the Office of Private Voluntary Organizations, the Agency for International Development, which provided funding for the production;

And to the production team who are geniuses at turning pages of copy into “user friendly” materials - Nena Terrell (Publications Manager), Jacqueline Lucas (Publications Program Associate), and Patrice Gallagher (graphic designer).

We hope this manual can be a useful tool for meeting the challenge in your community: enabling women to pursue viable businesses.



Suzanne Kindervatter  
Director of Technical Services  
OEF International



# Notes to the Facilitator



For most economists, a business “feasibility study” involves complex market analysis and projections. This manual is based on a different approach, particularly “appropriate” for Third World women’s micro and small-scale businesses.

These “notes” explain the feasibility study approach and give an overview of the manual.

# Letting Women Decide: Is This Business Viable?

A group of women in Peru were making and selling small knitted holiday decorations. They lived outside a large city in a poor community. Their income was crucial for providing food and care for their families, but they were not able to earn much from the sale of the decorations. Members of a community organization met with the women and talked about ways they might earn more money. The women were interested. But, what could they produce? And, how could they do it?

The women participated in a program of training activities like those in this manual. They explored options for different businesses. They determined the probability that a business would succeed. Finally, they decided to start a new business—a bakery—and planned how to begin.

Are the women in Peru similar to women in your community? The women needed to earn money in order to survive. They wanted to find a small business activity that was both possible and beneficial.

Starting a business is a risky effort. Even well-planned businesses fail due to broader economic forces. The purpose of this manual is to reduce the risk by enabling women to identify businesses that have prospects for success.

Poor women typically have a limited view of business options. They have had little opportunity to learn technical skills or to consider kinds of work that women may not traditionally do. They are often drawn to business possibilities that are most familiar, but that yield little or no profit. This manual enables women to explore business options and to study their potential for profitability. It enables women to find out if a business is a good idea.

In many development programs, an “expert” decides on a business idea and then provides technical training to prepare women for that business. This manual is based on the idea that women themselves can and should be involved in the process of studying a business. If they are to be successful entrepreneurs, women need to make decisions and solve problems about their business from the start. For small-scale producers, the training in this manual will most likely be sufficient for determining business viability. With a larger-scale venture or a product with a complex technical process, outside experts may need to be called in to provide additional information. However, what’s important is that the “expert” adds to the women’s study, rather than carries out a separate study.

Refugee women in Somalia have done it. So have farmers in Senegal and urban dwellers in Central America. Without being able to read and write, they have gathered information and made intelligent decisions about business options and business operations. The women in your community can do it too!

# Feasibility Study: What it Means

“Feasibility study,” as used in this manual, is the term used for finding out if a business is do-able, marketable, and profitable. Basically, a feasibility study involves answering this question: are we able to produce a product or service that people want to buy and that we can sell for a profit?

To answer this question, a group gathers information and then analyzes it. There are a series of six steps, listed below, that guides the “feasibility study.”

## THE SIX STEPS FOR A FEASIBILITY STUDY



**Choose a product or service to sell.**

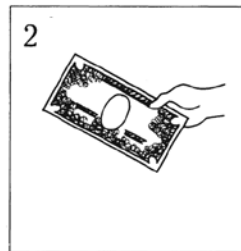

**Find out if people will buy the product or service.**



**Determine how the business will operate.**

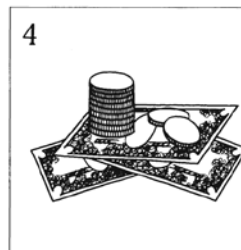

**Calculate business expenses.**

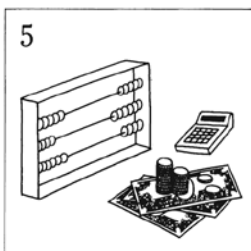

**Estimate sales income.**

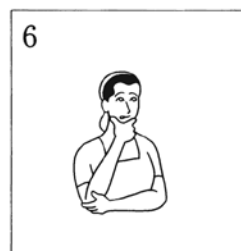

**Decide: Is the business a good idea?**

Here is an example of how one group of women did a feasibility study. They wanted to start a small grocery store.

First, they found out whether people would buy things from their store. Then, they found out how much it would cost to start the store and keep it operating. Next, they estimated how much they would sell and what their sales income and profits would be.

During the study, the women realized that there were already three stores in their community. They thought the competition in the grocery store business was too strong and that their business might fail. They also realized that they needed a lot of money to start the grocery store—more than they had or could borrow. So the women rejected the grocery store idea.

They thought about other business possibilities and liked the idea of a furniture repair service. When the women did their feasibility study for this idea, they decided that it could be viable. The women gave up one business idea and found another. If they had not done the feasibility study and tried to start the grocery store, the business probably would have failed. But, now they know that the furniture repair business has a chance for success.

Another group was already raising and marketing pigs. They used the feasibility study to review their operation and found that high feed costs were decreasing their profits. They decided to look into cheaper kinds of feed, as well as other ways to reduce their business expenses. By following the six steps for a feasibility study, the women in your program will be able to assess the viability of their business ideas or review their current business performance.

# What is in the Manual

The activities in this manual enable women to learn how to do a feasibility study, and then actually to do their own study.

Take a look at the “Table of Contents” at the front of the book. After the “Notes” and “Planning” sections, the manual has two major parts: “Feasibility Studies-Learning the Steps” and “Doing a Feasibility Study.”

“Feasibility Studies-Learning the Steps” begins by introducing participants to the concepts of a feasibility study in an easy-to-understand way. A story and series of posters depict the experience of one group of women interested in starting a business.

Following this introduction, participants then go step by step through the feasibility study process using a possible product or service as an example. For each of the six steps, there are several learning activities that help the participants learn and apply the concepts involved. By the end of this section, participants gain the basic concepts and skills for doing their own study.

“Doing a Feasibility Study” has three sub-sections: “Tips for the Facilitator,” “Getting the Information We Need,” and “Deciding on Our Business.” These include training activities and guidelines that enable women to conduct their own “research,” analysis, and decision making related to business options. The result of this section is a concrete “business plan” for either starting or strengthening a business.

Throughout the manual, each learning activity is organized in the same way. As an example, turn to page 46. The activity includes: purpose, time, rationale, preparation for the session, and steps to follow. Make sure to read the entire manual before your program. Then, for each day’s program, re-read the activities planned and prepare the materials needed. During each training session, keep your manual open to the appropriate training activity and use the steps as a handy reminder of what to do.

Finally, a word to facilitators who do not have a background in business or economics. Some of the financial analysis included in the manual may be new and at first seem difficult. But do not be hesitant. With a bit of time and patience, you—and the women in your program—will feel confident and comfortable with terms like “cash flow” and “investment plan!”

## Training Goals

As a result of this training, participants will:

- Understand the importance of a feasibility study.
- Learn the six steps for conducting a feasibility study.
- Plan a feasibility study.
- Carry out their own feasibility study.
- Decide whether to start a new business or how to strengthen a current business.
- Prepare a business plan.

## Notes:

# Learning by Doing

Your friend wants to know how to fix her bicycle; your child wants to know how to plant a garden. How can you help them learn these skills? One way is by telling them what to do. A more effective way is to show them what to do, and then let them try it themselves.

“Learning by doing” is the approach used in this manual. In the first part of the program, participants learn and practice each of the six steps of a feasibility study. This prepares them to actually do their own study.

When the goal of an educational program is transmitting information, such as a history class in school, a teacher talks and students for the most part listen. However, when the goal of an educational program is developing new skills and taking action, the interaction looks and feels different than education in the traditional classroom.

Usually, everyone sits in a circle. The atmosphere is relaxed. Members of the group share ideas with one another, not just with the “teacher.” People laugh. People look serious. The level of interest is high, because the participants are dealing with things that are important to them.

Often, the participants in this training program will be together in small groups and will share their opinions and different ideas. Each person will bring a valuable idea or opinion. And no one’s opinion will be more right than another person’s opinion. In fact, each person will probably be an expert in some aspect of the feasibility study.

“Learning by doing” has other positive benefits in addition to being an effective method for gaining new skills. When everyone participates in training activities, they become more creative and learn to work together in many ways. Also, when people begin to make their own decisions, they gain more confidence in their ability to improve their lives. They may never have felt this way before...or believed it was possible.

Successful businesswomen are able to solve problems and change their businesses in response to changing markets. “Learning by doing” helps women acquire the abilities they need to manage a business effectively: concrete business skills, plus those less tangible “entrepreneurial capabilities.”

# Planning Your Program

You now have a sense of what a “feasibility study” is and why it is important for women to be involved in doing their own study. At this point, you are probably thinking about how to organize your program. This section will help you plan a program for women in your community.



# Who Can Use This Manual

This program is for women who want to start a business or to review an existing business. Over the course of the program, the facilitator conducts a series of training activities that enable women to learn how to do a feasibility study and then guides the participants in actually doing their own study. The activities are designed for 12-15 participants.

Women who want to start a business will go through all the activities included in the manual. For those who want to assess their businesses, certain activities can be omitted. These are listed on page 20 and in the "Purpose" section of the separate activities.

The training is oriented to group businesses, but it has been used for individual enterprises as well. The actual feasibility study is more difficult if it is carried out by only one person, particularly if she cannot read and write.

In addition, the training is appropriate for many kinds and sizes of business. For instance, a group of twenty women in Somalia were interested in starting a nursery to sell tree seedlings. In Honduras, a group of ten women studied commercial pig-raising starting with seven pigs, while in Peru, women investigated operating a bakery and store. The feasibility study is adaptable to larger businesses as well, such as a community food processing plant, but the financial analyses will be more extensive and may require assistance from an outside resource person.

Here are some of the things that were important in other training programs related to the kinds of facilitators and women who can best use this book. Check the things that apply to you and your group to decide if this training is what you need.

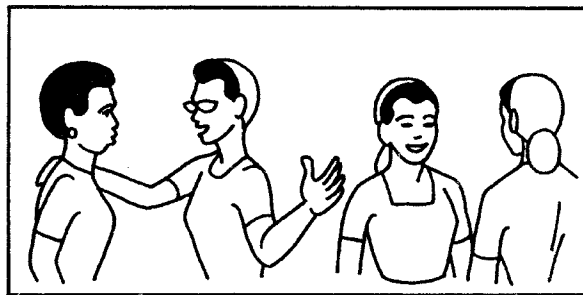

## ABOUT THE WOMEN

- Have experience in working together.\*
- Live near each other.
- Interested in a collective small business. (Reading and writing abilities not necessary!)

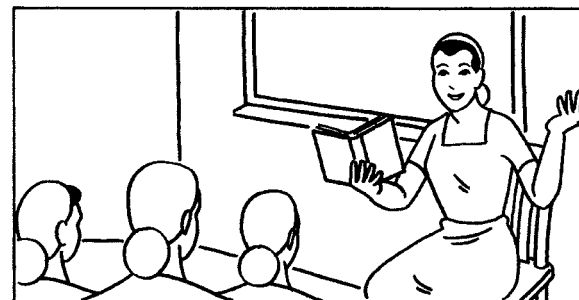

## ABOUT THE FACILITATOR

- Willing to listen.
- Good communication skills.
- Respects the women in the community.
- Wants to work with women in the community. (Previous business experience not necessary!)

\* For groups with little or no experience in working together, use "group building" training before the "Feasibility" training to make the women feel more comfortable with each other. Two helpful books are: *Women Working Together for personal, economic and community development* and *Navamaga: Training Activities for Group Building, Health and Income Generation*. Both are available from OEF International.



# Preparing Facilitators to Use the Manual

“Learning by doing” is just as important for facilitators as it is for participants. The best way to prepare for using this manual is to practice conducting the activities with a small group of colleagues, using a business with which you’re familiar. Since some of the business material may be new, it helps to be able to discuss the concepts with others. If this is not possible, it is important to read the manual in full before using it, and then to re-read the activities for each particular session before it’s held.

If you need to prepare others to use the manual, practice is also the key. Depending on the skills and experience of the facilitators, you may want to introduce the activities gradually. For example, in Somalia, young women with no training or business experience learned to use the manual. Each morning, they participated in a session conducted by a facilitator-trainer. Then, in the afternoon, they conducted the same session with the women in their program. That way, the facilitators immediately applied what they learned and were not overwhelmed by too much information at the outset.

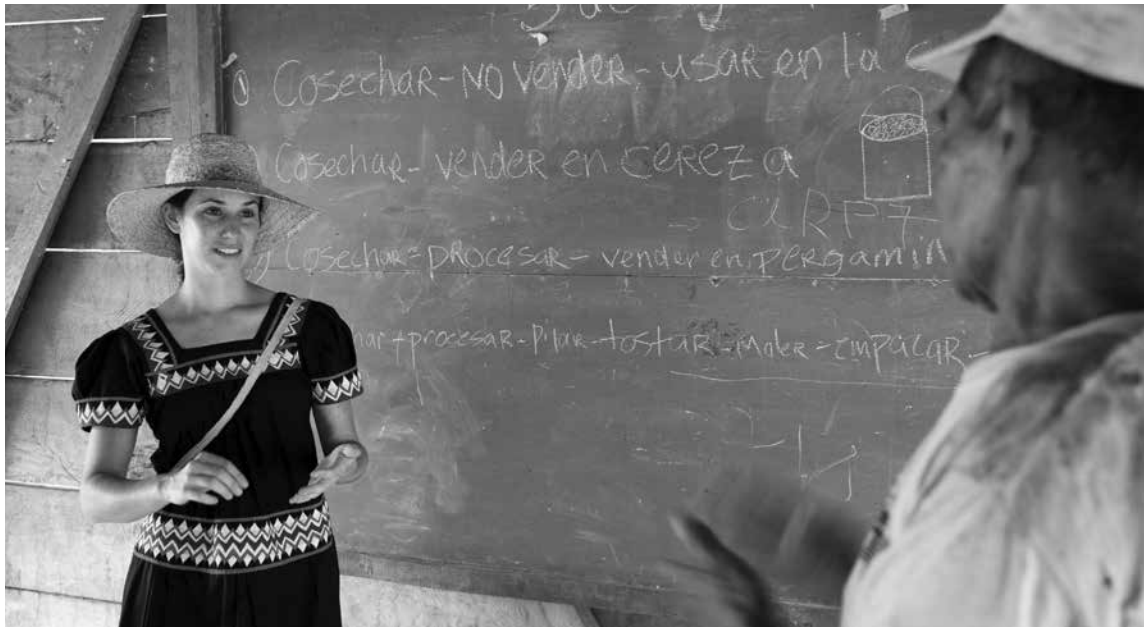

## A Word About Literacy

This training can be done with groups of women who cannot read, women who can read but not write, and those who can both read and write.

If the activities are done with a group who cannot read, they may require longer time, and you may need extra outside help with some sessions, particularly those that involve financial analysis. Also, you will need to work closely with your group during the time they actually do their own study.

For groups who can read, it is important to post the schedule and goals and put session materials on the chalkboard or large paper every day.

## Notes:

# Where to Meet

Since this is a training program for adults, it is best to conduct it in a location that does not remind participants of their school days. As children, they probably thought that the teacher had all the answers. They listened patiently and asked few questions. We want the opposite to happen in this training. We want them to ask lots of questions, to contribute their own ideas, to think and behave differently, and to see you as someone who seeks answers with them.

This means two things to you:

- Find a location that is not the local school.
- Arrange the meeting place in a way that does not remind the women of a classroom, such as:

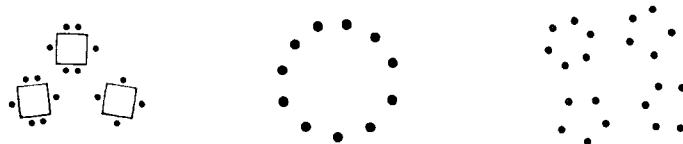

Because this is the kind of training that will be new to some people, it is important to let them know just what will be happening. The schedule and the goals of the training program should be posted and left up every day. Also, put up the six feasibility study step posters as you complete each step (see pp. 43, 51, 57, 62, 88, 101).

# What Materials to Prepare

For all sessions, you will need a chalk board or large sheets of paper such as the paper on which newspapers are printed. Call your local newspaper to find out where you can purchase newsprint. Each session in the manual includes detailed instructions titled "Preparation for the Session." Read them well in advance of conducting each session in order to gather materials.

For the first session, "Why Do a Feasibility Study?," you will need a local artist to create a series of posters (see p. 33 for instructions).

In the section on "Doing a Feasibility Study," take special note of the background information and guidelines for assisting the participants.

# How to Arrange a Schedule

The entire Feasibility Study program usually requires about two to three months of part-time involvement to complete.

During the development of the materials in Latin America and Africa, every effort was made to make them as concise as possible because of the women's busy schedules. At the same time, business development is difficult. So, it is important to include all the necessary steps for assessing business viability. Local trainers and participants helped define "the most essential" activities. These are what the manual includes.

Participation in the Feasibility Study program involves the following time commitments:

## **A Feasibility Study — Learning the Steps**

### **25 Hours**

- structured training activities

## **Doing Your Own Feasibility Study**

### **1-2 Months (part-time)**

- 2-3 hour "planning meeting"
- field visits to gather information
- several 1-2 hour meetings to discuss and analyze the information and to make the business plan.

Depending on women's schedules, the initial 25-hour training can be held in one week or spread out over two—three weeks. See the "possible schedules" for ideas on how to arrange the activities.

Since the Feasibility Study program continues beyond this initial training, the program should be planned for a period when women may have time available. For instance, in Senegal, women participated in the program after the harvest season.



# Possible Schedules for “Learning the Steps”

## 5-6 Hour a Day Training

Day 1	Day 2	Day 3	Day 4	Day 5
• Begin the Day Activity	• Begin the Day Activity	• Begin the Day Activity	• Begin the Day Activity	• Begin the Day Activity
<ul style="list-style-type: none"> <li>• WHY DO A FEASIBILITY STUDY? What is a Feasibility Study? What We Will Accomplish We Can Do It!</li> <li>• STEP ONE: CHOOSE A PRODUCT TO SERVICE OR SELL Exploring Women’s Work Things to Consider in Identifying Business Ideas Which Business Should We Study?</li> </ul>	<ul style="list-style-type: none"> <li>• STEP TWO: FIND OUT IF PEOPLE WILL BUY YOUR PRODUCT OR SERVICE Looking at Customer Demand Will People Buy What We Plan to Sell?</li> <li>• STEP THREE: DETERMINE HOW THE BUSINESS WILL OPERATE What We Know, What We Need to Find Out How Will We Work?</li> </ul>	<ul style="list-style-type: none"> <li>• STEP FOUR: CALCULATE BUSINESS EXPENSES Types of Business Costs Finding Examples of Business Costs</li> </ul>	<ul style="list-style-type: none"> <li>• STEP FOUR: CALCULATE BUSINESS EXPENSES What Do We Need to Buy? How Much Will It Cost?</li> <li>• STEP FIVE: ESTIMATE SALES INCOME Selling a Product or Service How Much Can We Sell and for How Much?</li> </ul>	<ul style="list-style-type: none"> <li>• STEP SIX: DECIDE—IS THE BUSINESS A GOOD IDEA? How to Calculate Profit and Cash Flow What Will Our Profit Be? What Other Benefits Are Important? Is the Business a Good Idea?</li> </ul>
• End the Day Activity	• End the Day Activity	• End the Day Activity	• End the Day Activity	• End the Day Activity

## 2-3 Hour a Day Training

Day 1	Day 2	Day 3	Day 4	Day 5
• Begin the Day Activity	• Begin the Day Activity	• Begin the Day Activity	• Begin the Day Activity	• Begin the Day Activity
<ul style="list-style-type: none"> <li>• WHY DO A FEASIBILITY STUDY? What is a Feasibility Study? What We Will Accomplish We Can Do It!</li> </ul>	<ul style="list-style-type: none"> <li>• STEP ONE: CHOOSE A PRODUCT TO SERVICE OR SELL Exploring Women's Work Things to Consider in Identifying Business Ideas Which Business Should We Study?</li> </ul>	<ul style="list-style-type: none"> <li>• STEP TWO: FIND OUT IF PEOPLE WILL BUY YOUR PRODUCT OR SERVICE Looking at Customer Demand Will People Buy What We Plan to Sell?</li> </ul>	<ul style="list-style-type: none"> <li>• STEP THREE: DETERMINE HOW THE BUSINESS WILL OPERATE What We Know, What We Need to Find Out How Will We Work?</li> </ul>	<ul style="list-style-type: none"> <li>• STEP FOUR: CALCULATE BUSINESS EXPENSES Types of Business Costs</li> </ul>
• End the Day Activity	• End the Day Activity	• End the Day Activity	• End the Day Activity	• End the Day Activity
Day 6	Day 7	Day 8	Day 9	
• Begin the Day Activity	• Begin the Day Activity	• Begin the Day Activity	• Begin the Day Activity	
<ul style="list-style-type: none"> <li>• STEP FOUR: CALCULATE BUSINESS EXPENSES Finding Examples of Business Costs</li> </ul>	<ul style="list-style-type: none"> <li>• STEP FOUR: CALCULATE BUSINESS EXPENSES What Do We Need to Buy? How Much Will It Cost?</li> </ul>	<ul style="list-style-type: none"> <li>• STEP FIVE: ESTIMATE SALES INCOME Selling a Product or Service How Much Can We Sell and for How Much?</li> </ul>	<ul style="list-style-type: none"> <li>• STEP SIX: DECIDE—IS THE BUSINESS A GOOD IDEA? How to Calculate Profit and Cash Flow What Will Our Profit Be? What Other Benefits Are Important? Is the Business a Good Idea?</li> </ul>	
• End the Day Activity	• End the Day Activity	• End the Day Activity	• End the Day Activity	

NOTE: These sessions can be held over a two to three week period.

# For Women With Existing Businesses

This manual can serve as a guide for women who want to review the performance of their business, as well as for women who want to start a business. Here are some ideas for focusing the program on an existing business.

## **PART 1: “LEARNING THE STEPS”:**

If the women in your program already have a business; “Step 1—Choose a Product or Service to Sell” from your plan. Begin with Step 2 and follow through to Step 6, using the women’s actual business in each step. For the sake of clarity, all the activities are written from the perspective of starting a business, but each step is also adaptable to a business review. Further suggestions for adaptation are given in the “Purpose” sections of the activities.

## **PART 2: “DOING THE FEASIBILITY STUDY”:**

In “Learning the Steps, women with existing businesses actually conduct a short review of their own businesses. Therefore, this second of the program may take less time. The women may not need to gather as much information as with a new business. However, the women may conclude that their existing business is not viable and that they want to look for another business possibility. In this case, they need to carry out a feasibility study for the new business idea.

# Tips for the Good Facilitator

Use this checklist to help make your program successful:

- \_\_\_\_\_ Be a facilitator, not a teacher.
- \_\_\_\_\_ Use another facilitator to help you, particularly for the activities involving financial analysis.
- \_\_\_\_\_ Be well prepared and organized. Read the materials well in advance of the session.
- \_\_\_\_\_ Read each activity and adapt it to your local situation as appropriate.
- \_\_\_\_\_ Keep people working in different small groups and have different people in each group speak each time.
- \_\_\_\_\_ Ask participants (rather than you) to read or write materials on the chalkboard or newsprint at every opportunity. Keep yourself as a facilitator in the background as much as possible.
- \_\_\_\_\_ Ask “why” questions of the group to encourage discussion, rather than questions that can be answered with a “yes” or “no.”
- \_\_\_\_\_ Move around the room frequently. Do not stay at the “front.” Put posters and newsprint in different areas too.
- \_\_\_\_\_ Be flexible and change the schedule or activities as needed to keep your group’s interest. But read the “Rationale” before each session so you know why the schedule is organized as it is.
- \_\_\_\_\_ Remember that the more actively the women participate in the program, the more useful it will be for building new capabilities.
- \_\_\_\_\_ Start and end each session with good energy and enthusiasm.

# My Training Plan

Does the manual seem useful for your situation? If your answer is “yes,” you are ready to plan your own program. Each community, each group, each facilitator is unique. Adapt the program to your own special conditions.

The previous sections gave you ideas to think about in planning your program. Use this form to write your plan.

Who are the women who will participate in your program? What time do you have available for the program (on an average day, over the course of a year)?

---

---

---

If the women in your program are interested in starting a business, what are some business possibilities in your area? If they have a business, what kind of business is it and what problems do they have?

---

---

---

Where will your program be held? How will you arrange the meeting place?

---

---

---

What will be your training schedule? What months have you chosen for the program, and why? How will you arrange the 25 hour “Learning the Steps” training? (Review the charts on p. 16/17).

---

---

---



# My Training Plan



\_\_\_\_\_ - DAY PLAN

# Activities to Begin and End Each Day

Illiterate women with no business experience have participated in the activities in this manual and understood them. But learning new concepts and skills can be frustrating at times.

These activities are a way to begin and end each day of training on a positive note. The “begin the day” activities help create a comfortable atmosphere and promote lively discussion. The “end the day” activities are a means to identify any problems with the training.

Use these activities or ones like them to begin and end each day’s session.



## Examples of “Begin the Day” Activities

### GETTING BETTER ACQUAINTED

**Purpose:** To get to know each other and feel more comfortable in the group.

**Time:** 30 minutes.

#### Steps:

1. Ask each person to find a partner to talk with in the next 10 minutes. They should pick a person they do not know very well.
2. Tell each person to ask her partner:
  - What is your name?
  - What would you do if someone gave you \$100?  
(Note: Use an amount appropriate for your situation.)
3. After 10 minutes, ask the women to sit in a large group again.
4. Ask each person to introduce her partner and to tell the group about her partner’s answers to the questions.

## OUR STRENGTHS

**Purpose:** To encourage the women to think about themselves and their good qualities.

**Time:** 15 minutes.

### Steps:

- 1 Ask the women to think for a few minutes about something they have done that is very creative or something they are very proud of.
2. Ask volunteers to share this with the group.
3. As volunteers decrease, ask those people who have not participated if they would like to speak.

(Note: You may have to ask more questions to encourage the women to speak.)

## THE BEST EXPERIENCE OF MY LIFE

**Purpose:** To share some good things about our lives.

**Time:** 15 minutes.

### Steps:

1. Ask the women:  
—What was the best experience of your life?
2. After everyone has spoken, you can talk about all the talent and abilities in the group and how each person can help in a new business.

**Notes:**

## MIRROR GAME

**Purpose:** This is an activity purely for having fun. It should be done later in the training program when the women feel more confident. It will cause a lot of laughter.

**Time:** 10 minutes.

### Steps:

1. Ask a volunteer to leave the room or area.
2. When she cannot hear what the group is saying, tell the group to imitate everything she does when she comes back into the circle.  
If she scratches her arm, everyone should scratch their arms. If she laughs, everyone should laugh. If she talks, everyone should repeat what she says.
3. Ask the volunteer to come back into the circle. After a few minutes, ask the volunteer if she knows what is happening.



## THE TELEPHONE CALL

**Purpose:** To have the women talk about communication.

**Time:** 15 minutes.

### Steps:

1. Ask the group to sit in a circle.
2. Whisper in one woman's ear: "Our goal is to work together on a profitable business."
3. Tell the woman to whisper this message to the woman sitting beside her...and continue passing the message around the circle whispering.
4. When the whispered message reaches the last person, ask her to repeat it aloud for the group. It could be very different from the message you first spoke to the woman beside you.
5. In a discussion, ask the group:
  - Why did the message change?
  - How can we avoid misunderstanding what someone else says?
  - What do we learn from this?

## MEMORY GAME

**Purpose:** To help the women recall what they are learning in the training and to have some fun.

**Time:** 15 minutes.

### Steps:

1. Ask all the women to stand in a circle.
2. Explain that the group will list some of the things they have been learning about starting a business.
3. Have one person in the circle complete this sentence for the business in which they are interested.

*Example:*

"To start a chicken-raising business, you need \_\_\_\_\_"

4. Ask the next person to repeat what the first person has said, and to add another item.

*Example:*

First person: "To start a chicken-raising business, you need feed."

Second person: "To start a chick-raising business, you need feed and healthy chickens."

5. Ask each person in turn to repeat what the previous person has said, plus add another item.
6. When someone cannot remember what has been said, she should sit down.
7. Continue until one person is left standing: the "memory" expert!

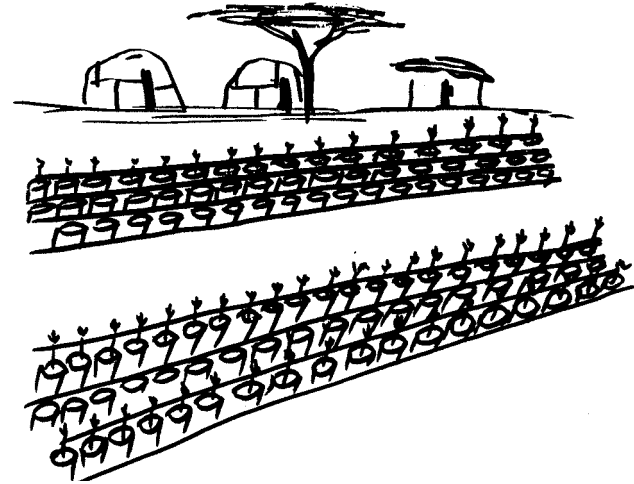

# Examples of “End the Day” Activities

How effective is the training program? This is important information to learn from the women themselves. While you think you may know how they feel, always ask the participants. They may surprise you. Remember that you are working together. If you take time to talk about the strong and weak parts of the program, you may be able to make some changes so everyone feels even better about the training.

## ACTIVITY #1

**Purpose:** To find out the participants’ reaction to the training program, what they like or do not like.

**Time:** 15-20 minutes.

### Steps:

1. Ask the people to sit in small groups of five or fewer.
2. Ask them to discuss:
  - What do you like best about the training so far?
  - What do you like least? Why?
3. Ask the women to sit in a large group again. Have someone from each small group tell the rest of the group the most important things that were said.

## ACTIVITY #2

**Purpose:** To find out if parts of the training program should be changed or remain the same.

**Time:** 20-30 minutes.

### Steps:

1. Ask the women to sit in a large group and think about these questions:
  - If this training program were being done for another group of women, which two things would you keep exactly the same?
  - Which two things would you change?
2. Go around the circle and ask each woman to share her answers. Write them down.
3. Explain to the women that because each woman is different that no training program will completely meet everyone’s needs. But, their ideas are very important in helping to make the rest of *their* training better and to help other groups of women.

### **ACTIVITY #3**

**Purpose:** Same as Activities #1 and 2

**Time:** 15 minutes.

**Materials:** Large paper and felt tip pen.

#### **Steps:**

1. Ask the women to think of one word that expresses their feelings or thoughts about the training. Encourage them to express what they really think. If they want to choose a “negative” word, like “boring,” that’s fine.
2. Have one woman state her word, and write it (the word or a symbol) on large paper posted on the wall. The other women should then state their words in turn, without stopping for discussion. Write each word or symbol down as it is said.
3. Now, ask the group to look at the list of words:
  - Do most participants feel positive or negative about the program?
  - Are many of the words similar, or different? Why?
  - Why does everyone choose the word she did? What is “good” and “not so good” about the training?
  - What should the trainer and group do tomorrow to make the training better?

### **ACTIVITY #4**

**Purpose:** Same as Activities #1 and 2.

**Time:** 10 minutes.

#### **Steps:**

1. Ask each participant to imagine returning home this evening after the training. Participants can close their eyes if they like. Ask them to think about talking to a specific family member or friend. What would they tell this person about the training?
2. Give the women a few minutes to think.
3. Ask each woman to tell her “story.”
4. Then, ask the group:
  - Have these stories given us any ideas about things we need to change in the training program?
  - What would you like to do differently tomorrow?

## ACTIVITY #5

**Purpose:** Same as Activities #1 and 2.

**Materials:** Pebbles, matches, or small objects that can be used for voting; cups; a piece of paper with a word or symbol, representing the different training activities used that day.

**Time:** 15 minutes.

### Steps:

1. Post the pieces of paper around the room. Explain what each piece of paper means. This is a way to review that day's activities for the group. Put a cup under each piece of paper.
2. Give each woman 3 of the voting markers. Ask her to "vote" for her favorite parts of the training. Participants can distribute the markers any way they like. They can put all three markers in one cup, or they can put them in two or three cups.
3. Have participants "vote."
4. Count the markers in each cup (Note: If participants can count, they can do this.)
5. Discuss:
  - What did the voting show? Were some activities better liked than others? Why or why not?



# Part One: Feasibility Studies: Learning the Steps

The training activities in this section enable participants to learn how to do a feasibility study.

A feasibility study involves collecting and analyzing a lot of information about customer demand for a product, estimated business costs, and expected sales. The manual tries to make this process as simple as possible, dividing a feasibility study into six steps.

Take a look at the chart on the following page. The training activities in this section of the manual will enable your group to find out what to do in each step on the chart. In the activities, they will choose one idea for a product or a service as an example. They will then follow the steps to determine if this idea seems feasible. They will carry out a “practice” feasibility study in a short amount of time.

Then the group will have the skills needed for carrying out the actual study, which is more extensive and requires a few more weeks or even months of time to complete.



# The Six Steps For a Feasibility Study

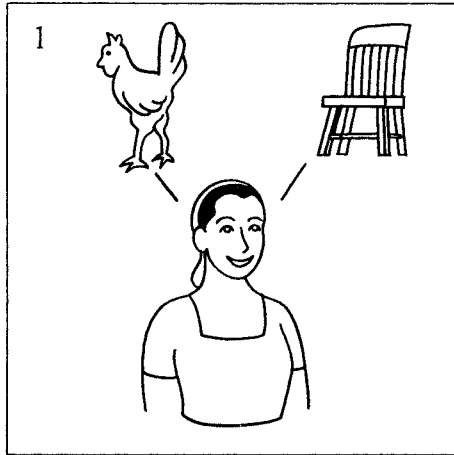

**Choose a product or service to sell.**

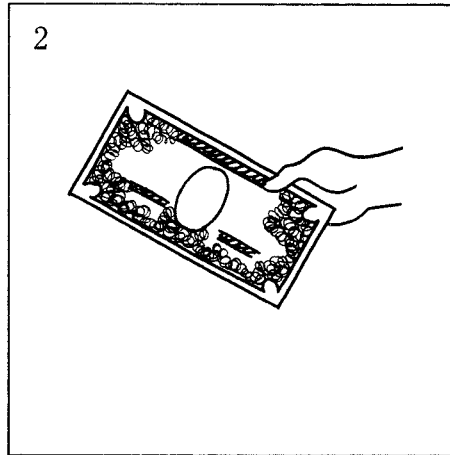

**Find out if people will buy the product or service.**

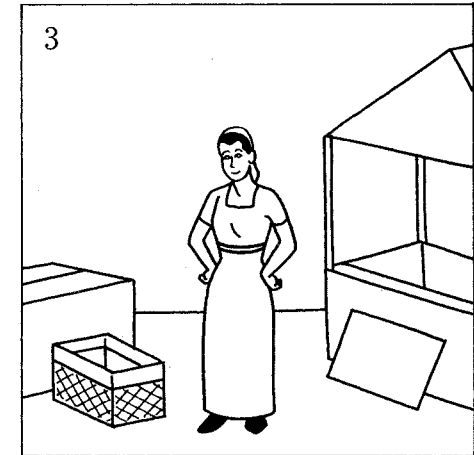

**Determine how the business will operate.**

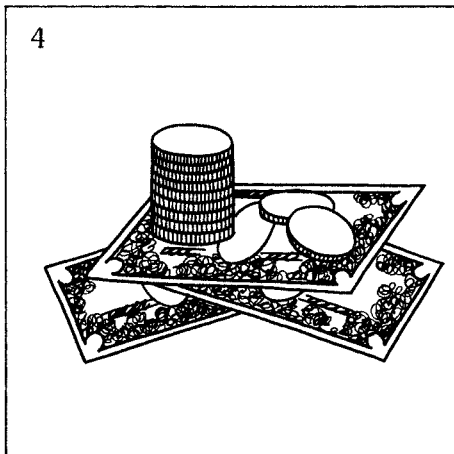

**Calculate business expenses.**

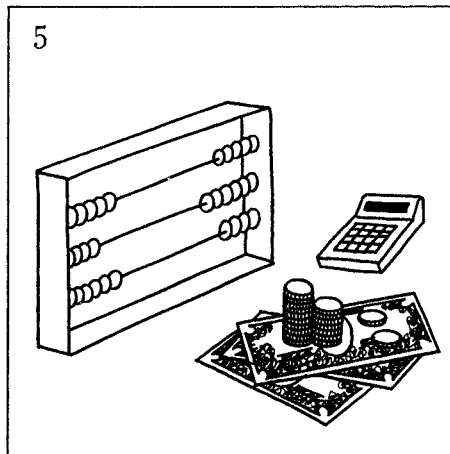

**Estimate sales income.**

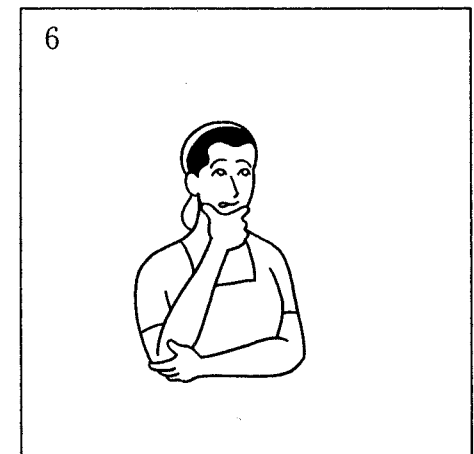

**Decide: Is the business a good idea?**

# Why Do a Feasibility Study?

## WHAT IS A FEASIBILITY STUDY?

**Purpose:** To introduce the idea of a feasibility study and why it is important, in a way that participants can easily understand. (Note: For women with existing businesses, this activity gives an overview of things to consider in assessing business performance.)

**Time:** 1 hour.

**Rationale:** For many people, starting a business means buying materials and producing something. But there is much more that needs to be considered in business development, from who will buy the product to production costs to likely sales income. Without this broader analysis, a business is about certain to fail. The story and posters in this activity show the contrast of starting a business without a feasibility study and with a feasibility study.

## PREPARATION FOR THE SESSION:

### Materials:

Posters and poster story. See “Instructions” for adapting the story and posters (p. 33) and sample story (p. 34) and posters (p. 151-170).

1. Read the “Instructions for Adapting the Feasibility Study Story and Posters.”
2. Rewrite the story. Create posters appropriate for your locale.
3. Practice telling the story with the posters, before you do this activity. Prepare to ask the participants questions to encourage them to discuss the story.

### Steps:

1. Welcome everyone to the session. Start with a “begin the day” activity. (Note: If participants do not know each other, “Getting Better Acquainted” is a good activity to use—see p. 22).
2. Explain to participants that you are going to tell them a story about women like them who wanted to have a successful business.



3. Present the story and posters. Go slowly, and ask lots of questions to get the participants' reactions.
4. After the story is over, ask the participants:
  - How are these women like us?
  - What did we learn about starting a business?
5. To end the session, explain that:

"There is a name for what the women in the story did—it is called a "feasibility study." A feasibility study is a way to find out if a business is a good idea. In this program, you will learn how to do a feasibility study so that you can choose and plan a business that has a chance for success."

## **A Feasibility Study ....**

is gathering and analyzing information to find out if a business is a good idea or not. You will ask questions and organize your information. This helps you to know if your idea is "feasible" or possible. Then you can decide if your business idea is really one that can increase your income.

## Instructions for Adapting the Feasibility Study Story and Posters

The Feasibility Study story and posters provide a simple, true-to-life introduction to why a feasibility study is important and what it means. The story and posters have proven to be an invaluable visual reference for women who cannot read. They identify with the characters, discuss the issues with great excitement, and later refer back to the story when learning the steps for their own study.

The story has been used in many different settings, from urban areas of Central America to isolated refugee communities in Somalia. The amount of time it takes to present and discuss the story depends greatly on your group. In one community, women spent over two hours on the story. In another, the story plus a spontaneous role play by the participants took less than thirty minutes.

Lack of literacy or numeracy skills has not been a problem for participants in analyzing the story. Women typically have had experience in dealing with money and are able to do most of the calculations called for in their heads.

To make the story real for the participants in your program, you will need to adapt it to your locale. The story and posters included here were created in Senegal for rural women. The following steps will enable you to adapt the story and posters (located at the end of the manual on pp.151-170).

1. Read the story, with the posters (the numbers on the story and posters go together).
2. Choose two products from your own locale:  
First product: Requires some technical skill to produce  
Many local producers exist  
Limited market demand

Second product: Requires some technical skill to produce  
Sufficient market demand warrants more producers to produce  
Potential for profitability (i.e., costs are less than the expected sales income)

3. Change the name of "Aminta" and her friends to local names.
4. For #2–8:
  - a. Substitute the first product you chose for the tie-dying.
  - b. Remove all amounts of money. Write in the actual amounts for the product you chose. Make sure to use a higher expected sales price in #2 than in #6.
5. For #9–18:
  - a. Substitute the second product you chose for the soap.
  - b. Change the details on equipment and supplies to fit your product.
  - c. Remove all amounts of money. Write in the actual figures for the costs, expected sales, and profit for your product. If ten production cycles is too many for the product you have chosen, use a smaller number.

CAUTION: If the business projections do not show some profit, choose another product for #9–18.

6. Prepare real money or play money to use for the story presentation. (Note: Using real or play money greatly helps participants to "see" what is happening in the story.)
7. Find a local artist to draw 18 posters that illustrate your story (use those included in the manual as a guide).

# Poster Story From Senegal

1. This is Aminta. She lives in a village near here, and she's a lot like you. She has similar desires and similar problems. What do you imagine she's thinking about? (Discussion)  
One of her big concerns is her children. She would like them to go to school, but she can't afford the notebooks and pens they need. She'd also like them to have better food. Aminta has been thinking about what she can do to solve these problems. She's saved some money.



2. Aminta has 10,000.\* She wants to use the money to start an activity that can make more money. She remembers that her sister-in-law in another part of the country makes tie-dyed cloth. She watched her sister-in-law make the cloth, and she's also heard about tie-dying on the radio. Aminta says to herself, "I'm going to make 5 pieces of cloth and sell them for 2,500 each. Then, I'll make 12,500!" Aminta is very excited about her idea.



3. Aminta goes to town and stops at the first store she sees. She buys the supplies she needs, and she's surprised that she must spend her entire 10,000. She doesn't even have money left to take the bus home.



4. But she walks home feeling happy thinking about how successful her tie-dying will be. When she gets home, she goes right to work. She's never done tie-dying before, and she isn't sure of some of the steps. It's a lot of work to make the five pieces of cloth.

5. What's happening here? Why is her husband upset? (Discussion) Yes, the tie-dying took so much time that Aminta couldn't watch the children and do work around the house. What will happen if Aminta's husband isn't happy with her tie-dying work? (Discussion) Aminta thinks, "My husband may be mad now, but he'll be happy when he sees the 12,500 I earn."



\* Note: The figures represent Senegalese francs (cfa). 10,000 cfa equals about \$30 US.

6. Aminta goes outside to collect her cloth to sell at the market. She's shocked to see that two pieces didn't turn out. Why? (Discussion) Aminta thought she would make 12,500 from the sale of the cloth (Note: Show actual money or play money here). Now Aminta cannot sell two pieces of cloth; how much less money can she make? (Discussion) That's right, 5,000 (2 x 2,500). (Note: Remove this amount from the money.) So, how much can Aminta still make? (Discussion) Yes, 7,500. (Note: Show the money that remains). However, Aminta already spent 10,000 on supplies! Aminta is discouraged, but she's very motivated and knows she made a mistake. She decides to sell the three pieces and do better next time.



7. She gets up early the next morning to go to the market, planning to be home by lunchtime. What does she see when she gets to the market? (Discussion) There are many women selling cloth like Aminta's, for 1,000 each. Since people bargain with the women for the cloth, the actual price is less than 1,000 each. She won't even make 3,000! She had planned to make 7,500. Aminta sits down to sell the cloth. How long do you think she stays at the market? What happens? (Discussion)

8. Now Aminta is very, very discouraged. She can't understand what she did wrong. She's asking for help: what should she have done differently? (Discussion) Note: In the discussion, encourage the group to consider these issues:

- Aminta should have found out how to produce good quality tie-dye. (She could have worked with her sister-in law; practiced on old pieces of cloth; etc.)
- She didn't realize how much time the tie-dye production and selling would require.
- Aminta needed to visit the market to find out: the selling price of the cloth; how long it takes to sell; how much the women make in a day, a week, a month; who takes care of things at home when they're at the market; where the women buy supplies; why people buy from one woman and not another, etc.
- Aminta worked on her own, rather than with a group. (Note: Review the posters #2–7 and ask how working in a group might have helped.)



9. Aminta listened to your advice. She wants to try again, and has called together four friends. She tells them what happened. One of her friends wants to try tie-dye again. But Aminta says that there are too many other women already making the cloth. "Let's think of something else," she says. Hadi, one of the friends, responds: "My grandmother used to make soap, and I helped her. I know how to make soap. Who needs soap?" (Discussion—point out that everyone needs soap; that it can be sold locally; that it is something people use and then buy again.)

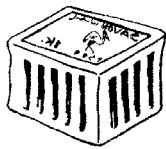

10. Here is a cake of manufactured soap that's sold in the store. It is 500 grams and sells for 150. The women think they can make and sell good quality soap for a cheaper price.

11. Two of Aminta's friends go to the market, following your advice. They want to be sure they can make money producing and selling soap. What do they see? How many women are selling soap? Is there much left? (Discussion) The women find out that the demand for the soap is great, and that it costs 100 per cake. What else do you notice about the soap, is it all the same? (Discussion) There is black soap and white soap. The white soap sells better. This is the kind of soap Hadi knows how to make. What about competition? The sellers say that they sell so much that there's room for the women to start selling too. What else do you think the women asked about? (Discussion—suggest these questions if the group does not: Where do you buy supplies? Do you know of sources for cheap palm oil? How much profit do you make? etc.)





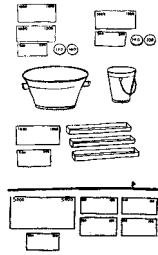

12. The women decide that they need to be careful about how much money they would spend on soap making and how much they would earn. First, they find out the cost of starting soap production. They will need a large steel tub for boiling—2,700; a small bucket for carrying water—1,700; and three wooden molds—1,500. The total cost of the equipment is 5,900. (Note: Use real or play money in #12-17.)

13. Now the group calculates how much it will cost to produce one batch of soap, or three molds full. They need 2 liters of palm oil—1,400; 500 grams of lye—200; and 10 liters of water, which is free. The total cost of supplies is 1,600.

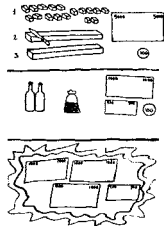
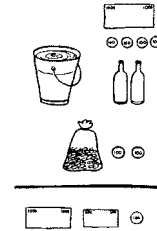

14. Next the women figure out how much they can earn from each batch of soap. Each mold can make 17 cakes of soap.  $17 \times 3$  molds yields 51 cakes. If a cake is sold at 100, total sales will be 5,100 ( $51 \times 100$ ). The women know they must deduct the cost of the palm oil and lye for each batch. They subtract 1,600 from 5,100 which leaves 3,500 profit per batch.

15. However, the women remember the cost of equipment, 5,900 for the tub, pail and molds. How many batches will it take to pay back these costs? (Discussion) The answer is two batches.

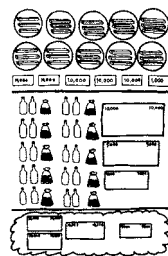

16. The women think some more about their production and sales. Let's say they have already made two batches and paid back their initial investment. How much will they make on 10 batches? (Discussion) [Answer: Sales income is 51,000 ( $5,100$  per batch  $\times 10$ ). Supplies cost 16,000 ( $1,600$  per batch  $\times 10$ ).  $51,000$  minus  $16,000$  equals  $35,000$  profit on 10 batches.] Besides profit, what else do the women need to think about? (Discussion) (Suggestions: How long it takes to make the soap; how quickly they can earn a profit; whether the demand for soap is constant or varies; etc.)

17. The women think they can make money making soap. But they ask themselves, "Have we taken all the costs involved into account?" Have they? (Discussion) (Suggestions: The group needs to think about transportation and their time as well). The women still think the business can be profitable. Now they discuss how they will work: how might they organize themselves? which tasks would take the most time? how would they take care of their children and responsibilities at home?



18. The women have now studied the soap making idea. They each have 2,000 to use for starting the business, or a total of 10,000. Should they start the soap-making operation? Why or why not? (Discussion: encourage the group to consider profit, as well as time, the production process, acquisition of supplies, transportation, etc.)

# What We Will Accomplish

**Purpose:** To discuss and agree on the goals and schedule of the training program.

**Time:** 30 minutes.

**Rationale:** You, the facilitator, have a plan of activities for the Feasibility Study program. It is important to present this plan to your participants, so that they can discuss how it fits with their interests and schedules. They should decide on the final schedule for the program and on any other rules they want to set. This will help them feel that the training is for their benefit and “belongs” to them.

## Preparation for the Session:

### Materials:

Large paper and felt tip pen.



1. Write the goals and schedule on a large piece of paper to post at your meeting place. For groups that cannot read and write, use symbols or numbers for the days of the week that they will be involved in the training program.
2. Re-read “Notes to the Facilitator” and write down ideas you’d like to present to your participants about the purpose and results of the training program.

## Steps:

1. Ask the participants to respond, one after the other, to the following questions:
  - Why did you come to this training program?
  - What do you hope to gain?
2. Tell the group your ideas about why the training program is important and what they can expect to accomplish. Post and read the training goals. Ask the group if they have any questions. If the participants’ ideas about what they hope to gain are very different from the training goals, discuss further how the program can meet their needs.

**Notes:**

## Training Goals

As a result of this training, participants will:

- Understand the importance of a feasibility study.
  - Learn the six steps for conducting a feasibility study.
  - Plan a feasibility study.
  - Carry out their own feasibility study.
  - Decide whether to start a new business or how to strengthen a current business.
  - Prepare a business plan.
3. Post and present the training schedule. Explain that the first part of the program enables them to learn how to do a feasibility study and the second part involves them in actually doing a study. At the end, they will have a plan for starting or strengthening their business. Ask the participants if they have any questions or concerns about the schedule. Ask if they have any ideas for changes.
  4. Now, tell the participants that you would like to talk about how they will learn to do a feasibility study. Ask them these questions:
    - How do your children learn in school? What does the teacher do? What do the students do?
    - If you want to learn to do something, such as fix a bicycle, how do you learn? (Note: Point out that if we are trying to learn to do something, we usually learn best if someone shows us and then we practice ourselves.)
  5. Explain that in the training program, you, the facilitator, will usually not lecture. Instead you will help them discuss ideas and do things together. Everyone will have something to contribute to doing a feasibility study. And everyone's ideas and opinions are valuable.
  6. Ask the group if they would like to set any "rules" for the program, such as:
    - time and length of breaks
    - what to do if people come late or miss a session
    - any other rules the group feels are important.
  7. Ask for any other comments or thoughts about the training program.

# We Can Do It!

**Purpose:** To talk about courage and fear in beginning a project.

**TIME:** 1 hour and 30 minutes.

**Rationale:** Your participants may be hesitant about the training program and about starting or changing a business. This activity helps them understand that their feelings are natural and can be dealt with positively.

## Steps:

1. Tell the participants that this training involves doing new things. Ask the women:

“Are there times in your life when you have been afraid, but did something anyway?”

“Could you tell the group about them?”

“How did you feel after doing these things when you felt fear at first?”

“What gave you the courage to go ahead?”

“What happened as a result?”

2. Now, ask the women to think about starting a new business. Read the first phrase below and ask for volunteers to complete it. Then do the same for the second phrase.

“When I think of starting a new business, I am afraid of...”

“When I think of starting a new business, I have good feelings about...”

NOTE: For women with existing businesses, ask their feelings about changing their business.

3. Divide the women into groups of three or four members. Explain that each group will present a “skit” about a particular fear and how to overcome it. A skit is a short drama or play. The players create the words and story themselves.

4. Ask the women if they have any questions about what to do. Here is an example you can use to clarify what the skits should be about. For instance, one group was hesitant about meeting government officials to obtain certain resources. In their skit, they showed women visiting an official together and supporting one another to speak up.

5. Give the group about 15 minutes to prepare the skits. Visit each group during this time to help them prepare.

6. Ask the groups to present their skits, one by one.

7. After the skits are completed, ask

“How do you feel about starting (or changing) a business now?”

8. In closing, share some of these thoughts.

“Many of us feel nervous or worried when we begin a new project. We cannot avoid these feelings. Every one of us feels fear about the unknown or that we may not succeed at something. Sometimes we are even afraid that we may succeed and it will bring new responsibilities for us!

These are not bad feelings. Many times we go ahead and do something even though we are afraid. Then we may feel extra good afterwards because we have done something in spite of our fears.

We feel strong because we have had the courage to go ahead. We have done something to be proud of.”

9. If this is the end of your first day of training, make sure to use one of the “end the day” activities on p. 26.



# Step One: Choose a Product or Service to Sell

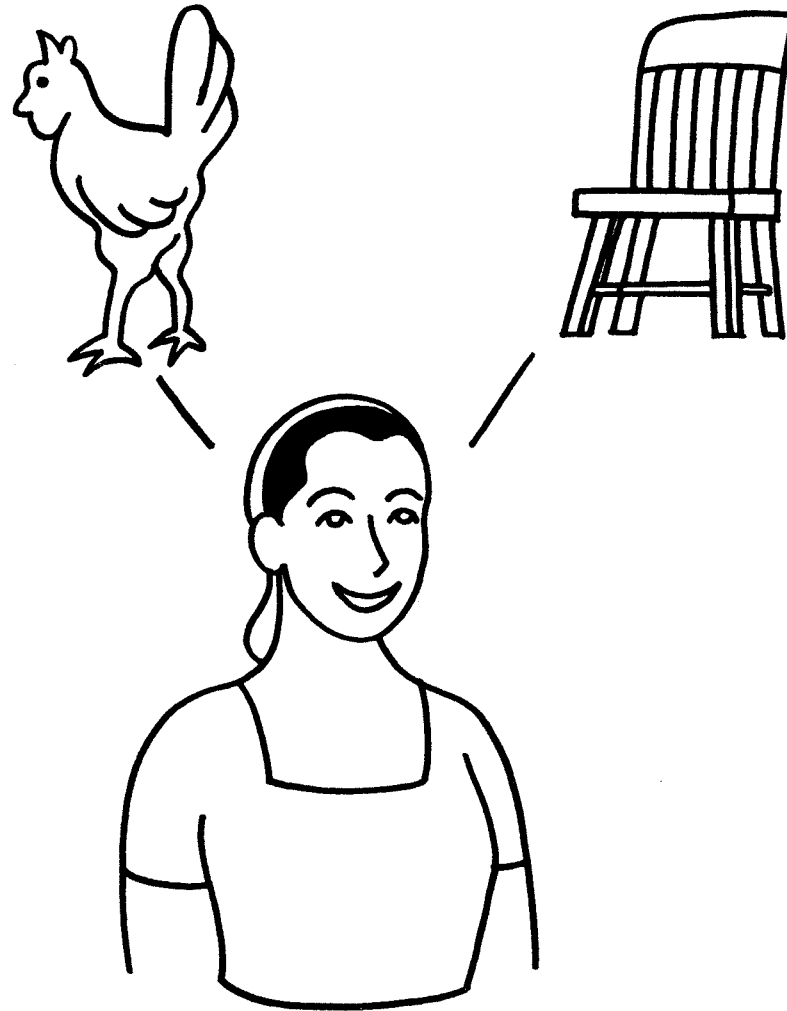

1



# Exploring Women's Work

**Purpose:** To expand women's views about the kinds of work women can do and to present some ideas for nontraditional work.

NOTE: If the women have an existing business which they want to review, skip to Step Two.

**Time:** 30 minutes.

**Rationale:** Women are often brought up to see themselves doing some kinds of work but not others. However, the kinds of work that may be new to them also may be most profitable. This activity helps women look at their assumptions about what women can and cannot do.

## Preparation for the Session:

### Materials:

Prepared skit (see "Women's Work Skit Instructions", p. 45); Another facilitator or participant to act in the skit; Step One poster.

1. This activity begins with a short skit which shows that women can work in many kinds of businesses. Read the "Skit Instructions" and practice your skit with another facilitator or participant before the session. Make sure to emphasize kinds of work that women do not traditionally do in your area, but that are possible for them to do.

## Steps:

1. Have the participants sit in a semicircle. Tell them you are going to put on a short play about women and work.
2. Introduce the two characters and perform your play.
3. After the skit, ask the participants:
  - "What did you think of the play?"
  - "What did you think of the first person's ideas? the second person's ideas?"
  - "What did you agree with? What did you disagree with?"
  - "Do you have any new ideas about work women can do? work you would like to do?"



- To end the session, show the participants the poster with the symbol and words for “Step One: Choose a Product or Service to Sell.” Tell them that this is the first step in doing a feasibility study. The next activities will help them identify some possible business ideas.

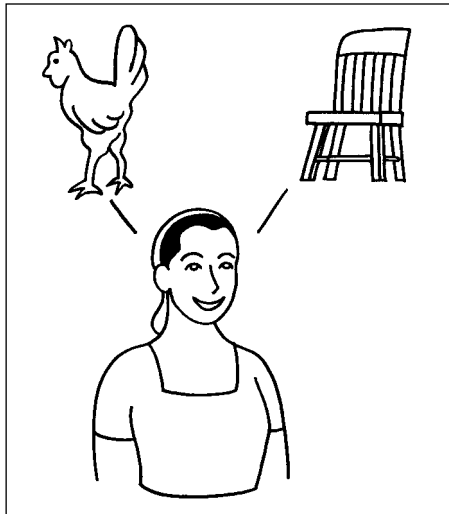

## “Women’s Work” Skit Instructions

This is a skit or play about work opportunities for women in your community. Every community is different. So, your skit will be different than a skit done somewhere else.

Here are some guidelines for creating your skit:

1. Prepare the skit before the meeting. In the skit, you can talk without a script like you would in a conversation. Or, you can write down the words and read them. The skit should be about 10 minutes long.
2. Include at least two people in the skit. The two can be two women or a man and a woman. Give them local names. You will take one part. Another facilitator or participant takes the other part.
3. The first actor thinks that women are good only at cooking, sewing, and caring for children. If women work, they should only be teachers, seamstresses, or have other similar jobs.
4. The second actor thinks that women’s income is important, even essential, to their families. He or she thinks women can do many things. Women should try new kinds of work. They should try to find work that is interesting and profitable.

5. In the skit, the first actor meets the second actor. They have tea or some refreshment, then start talking. They talk about what kinds of work their daughters can do when they get older. They argue about kinds of work women can do and can’t do.

### SOME IDEAS FOR KINDS OF WORK

Have the skit include some ways to earn that people think of as “men’s work,” such as carpentry, electrical repair, or animal raising.

6. Make the skit funny! The actors can get very angry!!
7. Remember: Try to talk about kinds of work women may not have considered. Help them think about new ideas. And also remember to have fun!



# Things to Consider in Identifying Business Ideas

**Purpose:** To enable participants to identify a wide range of business possibilities, which take into account local economic needs as well as the women's own values.

**Time:** 1 hour and 30 minutes.

**Rationale:** The first business idea that someone identifies is often not the "best." In this activity, women have the opportunity to discuss the kinds of businesses their communities might need and what they hope to gain from a business.

## Preparation for the Session:

### Materials:

Large paper and felt tip pen.

1. Before the session, seek out information on the community economy. This information might be available in reports from community offices or a university. Or, you might need to interview people who have a lot of contact with community members, such as extension agents or health workers. In particular, find out the kinds of economic activities that presently exist in the community and identify products or services that the community may need but does not presently have.

## STEPS:

1. Ask the participants to remember the poster story.  
"What was the first business idea the woman had? How did she choose it?  
What happened to the business?"
2. Tell the participants that choosing a business idea is a big decision. Here are three things we need to consider:
  - what people buy or want to buy
  - what we can do and how we want to work
  - what benefits we want to gain.Let's discuss each of these considerations.

### 3. WHAT PEOPLE BUY OR WANT TO BUY

—Tell participants that a business cannot succeed if people do not want to buy what we have to sell.

—Ask them:

“What kinds of businesses do we have in our community now?”

“What products or services do people need? Are there already businesses that provide these things?”

“What are some products or services that are not available in your community?”

NOTE: Give the participants some ideas from your own information-gathering and from the chart below.

#### Examples of Kinds of Business Activities

Commerce: Stores, storage facilities, transportation, restaurants, service (petrol station, barber shops)

Industry: Repair shops, tailors, construction, food processing, bakery, cloth dying, household goods (e.g. brooms, dishes)

Agriculture: Food production, animal raising

### 4. WHAT WE CAN DO AND HOW WE WANT TO WORK

—Explain that we must also think about the skills we already have or need and the kind of work conditions we want.

—Ask each participant to choose a partner. Tell the partners to ask each other:

“What skills do I have that could be useful in a business?”

NOTE: Encourage them to include things they can do with their hands (such as making dried herbs), things that would help the business operate (like counting skills), things they can do with people (such as settle arguments, organize groups, and so on).

—After a few minutes, have each woman report what her partner told her. When all have spoken, comment on the diversity of abilities and strengths within the group. Show appreciation for their abilities.

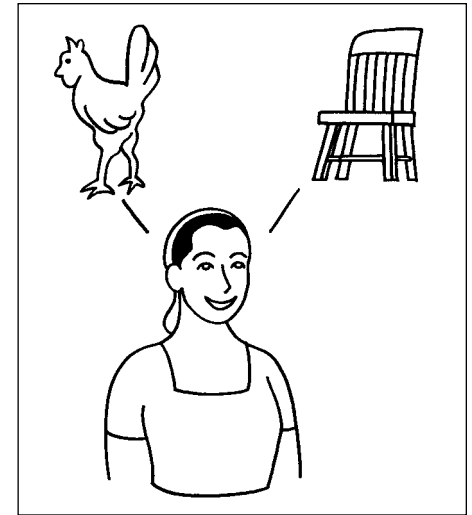

—Now, tell the group you would like them to think about their work conditions. Ask them: “What work schedule would you prefer?”

“Would you like to work near your home or away from home?”

“How will your children be cared for while you are working?”

“What else is important to you about your work?”

## 5. WHAT BENEFITS WE WANT TO GAIN

—Explain that everyone thinks of making money when they think of having a business. This is the most obvious benefit, but there can be other benefits too.

—Draw the diagram below on large paper. Explain that there are some businesses which mainly benefit the individual, some that benefit her family as well, and others that benefit the local community.

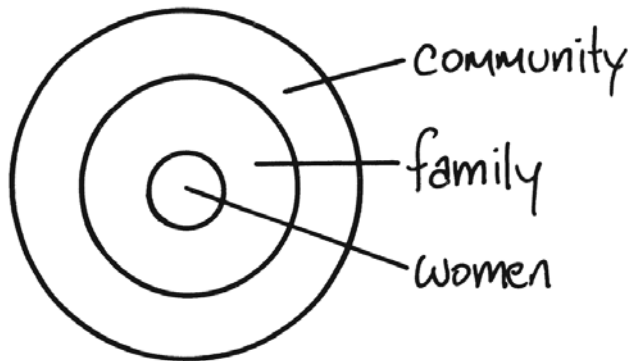

—Ask participants:

“Besides money, what would you personally like to gain from working in a business?”

“What would you like to gain for your family?”

“How might your business contribute to your community?”

NOTE: Add ideas from the box to the right if participants do not suggest them

### **Ideas for Business Benefits**

- Increasing pride in ourselves
- Improving our status in the community
- Working with other women
- Learning new skills
- Creating jobs
- Providing locally needed products or services
- Buying supplies from local merchants

6. To end this session, ask everyone in turn to complete this sentence: “I want a business that...”

(Examples: I want a business that makes more food available in my community; I want a business that only requires a few hours of work a day; I want a business that will give me the most income possible.)

# Which Business Should We Study?

**Purpose:** To choose a business to examine in the feasibility study training activities.

NOTE: The participants may decide to choose another business for the actual study.

**Time:** 1 hour.

**Rationale:** After listing many business possibilities, the women choose one idea that interests them and may be economically viable.

## Preparation for the Session:

### Materials:

Large paper and felt tip pen

Small pieces of paper and tape for voting

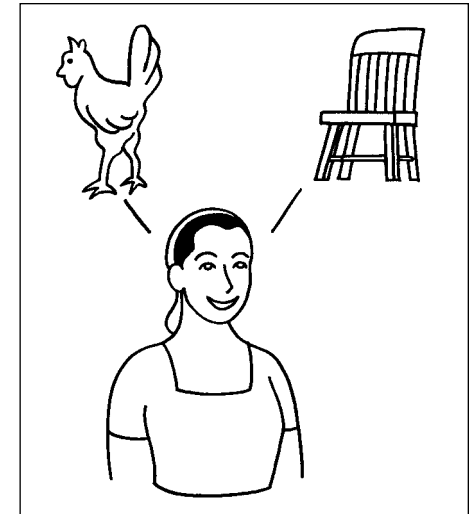

## Steps:

1. Begin by summarizing what participants discussed in the two previous activities (“Exploring Women’s Work” and “Things to Consider in Identifying Business Ideas”). Talk about some of the ideas related to work women can do and about some of the things the women said are important to them in a business.
2. Present the Step One poster (p. 43). Tell participants that the purpose of this session is to choose one business idea they want to study. First, they will make a long list of possible businesses. Then, they will vote on their preference.
3. Explain that they will “brainstorm” ideas to create the list. Read the guidelines for brainstorming (below) and ask if there are any questions.

### Brainstorming Guidelines

“Brainstorm” means listing ideas very quickly, with no discussion.

Everyone’s ideas are valuable. Remember:

- Quantity of ideas is important, not quality.
- No criticism or judgment is allowed until all ideas are out.
- Unusual or crazy ideas are encouraged!
- Try to add on to another’s ideas.
- Be creative!

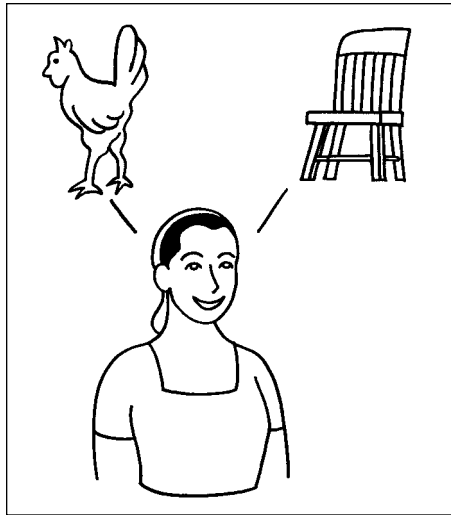

4. Write ideas down as the women say them (using words or symbols). When you have a long list and no new ideas are coming, stop and read the list to the women.
5. Ask the women to recall “things that are important to consider” about a business from the previous session.  
Ask:  
“Do you want to add any ideas to the list?”  
“Do you feel some ideas are not appropriate? If so, why?”
6. Divide the participants into groups of three or four. Tell the groups to discuss the business ideas and choose four possibilities. Have the groups meet for 10-15 minutes.
7. Ask one person from each group to list the business ideas chosen. Put each idea on a separate piece of paper and post it on the wall (if a business is listed more than once, just use one piece of paper).
8. After all the ideas are posted on paper, tell the group that you would like them to vote on the business idea which seems most viable and most interests them. Give each woman a small piece of paper and tape. Ask everyone to tape the paper to their choice.
9. With the participants, count the number of “votes” for each idea:  
If one idea has more votes than any other, ask the women:  
“Is this the business you want to study? Why or why not?”  
NOTE: Allow time for group members to discuss possible differences of opinion. If there is a tie, ask participants:  
“Which of the businesses would be the best to study? Why?”  
NOTE: Allow time for discussion of the advantages and disadvantages of the various ideas.
10. When the group seems to have reached a consensus, state the business the women have decided to study and explain that they will examine this business in the other five steps of the “feasibility study.”

## Step Two: Find Out if People Will Buy Our Product or Service

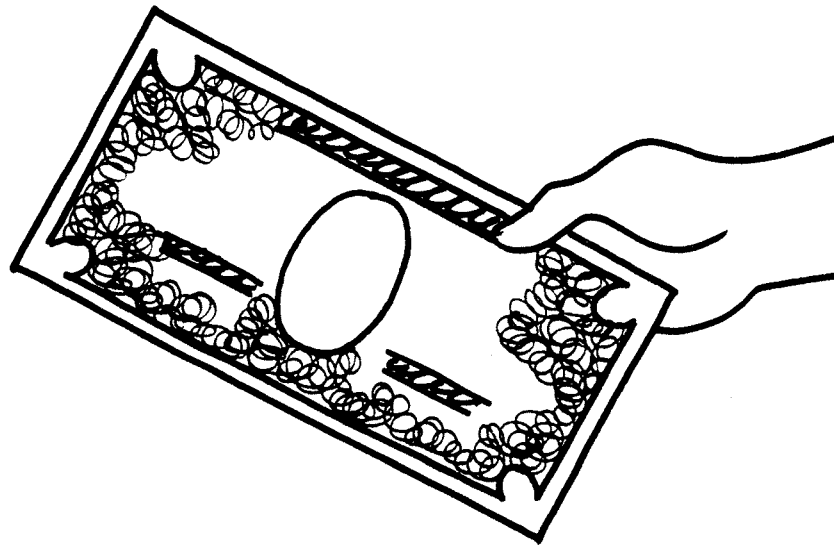

2

# Looking at Customer Demand

**Purpose:** To introduce the concept of “customer demand” as the key factor in developing a viable business.

NOTE: For participants with existing businesses, this activity requires no adaptation.

**Time:** 1 hour.

**Rationale:** Before starting a business, it is essential to know whether there are customers—a “market”—for a particular product or service. This activity helps participants understand what motivates people to buy and enables them to identify ways to find out whether people will buy their products. This step prepares them to do a local “market survey” during the actual feasibility study.

## Preparation for the Session:

### Materials:

Four local products and a symbol of a service business to show:

- A product with limited demand, such as a book.
- A product that is a “luxury” such as a television.
- A product that is a necessity, such as a food item.
- A symbol of a service with high demand, such as bicycle repair.

NOTE: Do not include the product or service chosen by participants in the previous activity.

1. Before the session, select four of the participants to be in a short play.

Choose participants that have participated actively in the previous sessions. Meet with the women and give each one of them a product or symbol. Then, explain that each will pretend to sell the item to the group, in short 5 minute presentations. Each in turn will:

- Stand in front of the group.
- Talk about her product or service.
- Give its price.
- Tell the group why it should be purchased.





2. Help the participants prepare the presentations if necessary. Ask them to practice together.

### Steps:

1. Present the Step Two poster. Explain that before starting a business, we must be sure people will buy what we plan to sell.
2. Explain that several participants have prepared a short play to aid everyone in thinking about why people buy or do not buy something. Have the four sellers present their products one by one.
3. After the products and services have been shown to the group, tell the women to choose one item to buy. They should raise their hands if they would buy the first, second, third or fourth items.
4. Discuss why people made their choices of what to buy:
  - “What did you think about when you made your choice?”
  - “Why was one product or service demanded more than others?”
  - “Why was one product or service demanded less?”

NOTE: The women may suggest such reasons as the product is more useful or attractive or less expensive.

5. Ask the participants to remember the poster story. What did the woman do after she decided on the second product? Why did she go to the market and what did she find out?
6. Now, ask the participants all to pretend that they are sellers: “For each of the four items, how can you find out if people will buy it?”
  - “Where would you go, whom would you talk to, what would you ask?”

NOTE: Add ideas from the box to the right, if participants do not suggest them.

7. Review the ideas the participants have stated. Tell them that they will use these methods of finding out “customer demand” when they do their actual study.

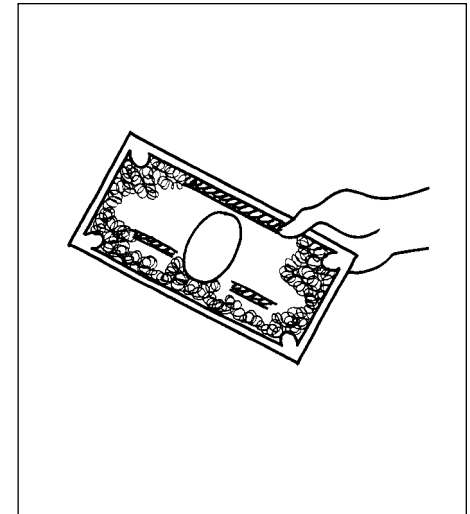

### Ways to Find Out What People Will Buy

#### Visit and Observe:

- Customers in a market or a store.
- What people have in their homes.

#### Talk to:

- People who are already selling an item.
- People you think might be interested in an item.
- “Experts,” such as extension agents who might have access to written reports.

**Notes:**

# Will People Buy What We Plan to Sell?

**Purpose:** To determine whether there is a market for the participants' planned business NOTE: For women with existing businesses, use this activity to reassess the market for their actual product or service.

**Time:** 1 hour.

**Rationale:** This activity helps participants examine more fully whether their product or service is something people will buy. They consider the demand for their business and the existing competitors.

**Preparation for the Session:** None

**Steps:**

1. Tell participants that they will now examine "customer demand" for their own business idea.
2. Divide the group in half. Tell one small group to think of all the reasons they can that people would want to buy their product or service. Tell the other group to think of all the reasons that people would not want to buy. Allow about 10 minutes for discussion.
3. Ask one or two members of each group to present the groups' ideas. Now, ask the participants: "Do you think people will buy your product or service? Why or why not?"
4. Ask the participants to think more about whom their customers might be:
  - Where do the customers live?
  - What age are they? Are they men, women, or children?
  - How much income do they have?
  - How might they find out about your product or service?
  - What else do you know about them?
  - Will they still want to buy your product or service in one year? in two years?

5. Explain to the participants that beside knowing customer demand, we must know about competition.

Discuss:

“Are other businesses producing what we plan to produce?”

“Is there enough customer demand for another business of this kind? How can we find out?”

“Why would someone buy from us instead of from a competitor?”

NOTE: If participants do not discuss them, suggest these factors: convenience, quality, personal relationship/trust, price, attractiveness of the product, and good promotion such as free samples or posters around town.

6. Now, tell participants that it is time to decide whether they think there is a market for their business idea.

Ask them:

“Do you think there are customers for your product or service?”

“Will they continue to want your product or service?”

“Do you think you can compete with the existing competitors?”

NOTE: If participants are unsure, remind them that they will do their full feasibility study later. If they can answer a tentative “yes” to these questions, it is sufficient.

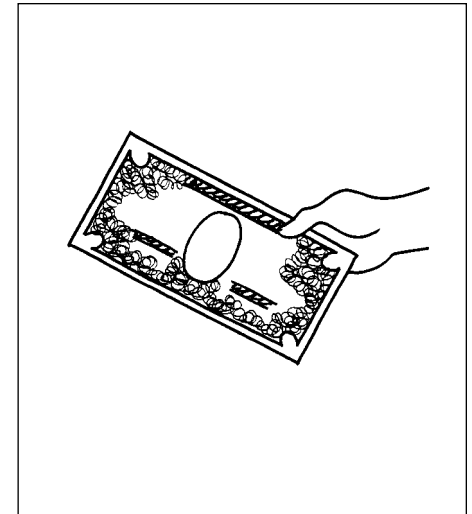

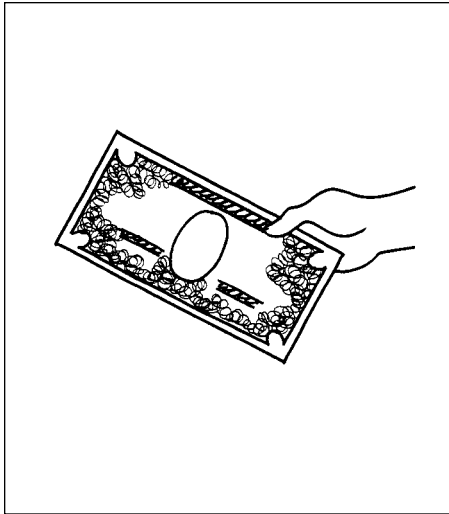

**Notes:**

7. If the participants answer “yes” to the questions in #6, proceed to Step Three. If not, return to Step One and choose another product or service to study. Women with existing businesses who cannot answer “yes” to these questions may also want to go to Step One and consider alternative businesses.
8. Tell participants that in the next meeting they will talk with someone who knows about the kind of business they have chosen. Ask them if they can suggest a good “resource person.” To end, ask them to think about questions they would like to ask the person.

**Special Note:** The first activity in Step Three involves arranging for a visit to a business or for a resource person to attend your meeting. Make sure to allow enough preparation time for you to make these arrangements. See “Preparation for the Session” for details.

## Step Three: Determine How the Business Will Operate

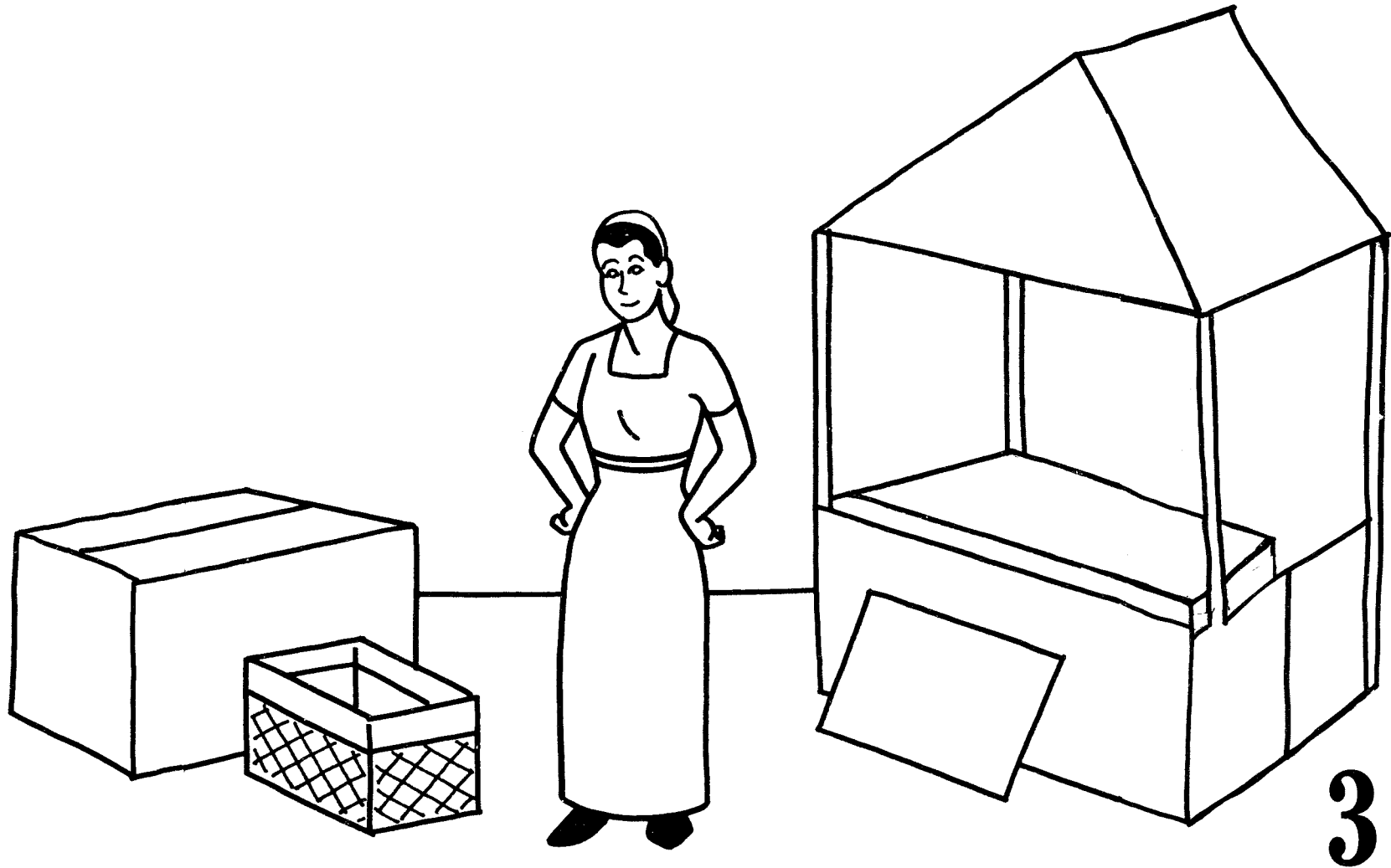



# What We Know, What We Need to Find Out

**Purpose:** To provide a means for participants to learn more about the operation of the proposed business, particularly its technical processes.

NOTE: This activity can serve as a review for women with existing businesses.

**Time:** 2 hours.

**Rationale:** Technical “know-how” is another factor in developing a successful small business. Even if women think they are experts in producing whatever they plan to sell, this activity enables the group to discuss the technical process together and to define ways to improve the process.

## Preparation for the Session:

### Materials:

Resource person (visit to workplace or presentation at meeting)

1. Before the session, contact someone who has a business like the one the participants are studying or someone who knows about this kind of business. Meet with the person and explain that the women would like to talk with her/him about how the business operates. If at all possible, arrange to take the women to the site of the business, so they can observe how things are done. If the resource person comes to your meeting, ask her/him to be prepared to demonstrate aspects of the technical process for your participants.

## Steps:

1. Arrange to meet with the participants for about 30 minutes before they meet with the resource person. Put up the Step Three poster.
2. Ask the participants to think back to the woman in the poster story. What happened when she tried to make her first product? Why did she have problems producing the items?

3. Tell the participants that today they will have a chance to talk with an “expert” about the business they are studying. Before the meeting, it is important for the group to decide what it needs to know.
4. Ask the participants:

“What do you already know about the business, particularly the production process?”

Have any women with experience or ideas speak in turn.
5. Now, we also need to think about:

“What don’t we know about the business or what are we unsure about?”
6. Encourage the participants to think of specific questions they would like to ask the resource person, such as:

“What is involved in the production process, from start to finish? How long does one production cycle take?”

“What resources/supplies do you need and where do you get them? How much do these cost?”

“What skills do you need and how do you learn them?”

“Who buys your product? Why?”

“What problems have you encountered?”

“What advice could you give us?”
7. Now the participants are ready to meet with the resource person. Make sure the resource person provides time for the participants to ask their questions.
8. After the meeting, talk with participants about what they learned. Ask them what they found out during the meeting that they didn’t know before. To summarize what they found most valuable, ask:

“The most useful information I found out for our business is....”



**Notes:**



## How Will We Work?

**Purpose:** To enable participants to discuss how they will organize their business, in terms of production, finance, and administration.

**Time:** 1 hour.

**Rationale:** Besides “technical know-how,” operating a business involves management of people, money, and resources. This activity helps participants plan how their business will be organized.

### Preparation for the Session:

**Materials:**

Large paper and felt tip pen.

### Steps:

1. Ask participants if they have any other ideas from the meeting with the resource person. Explain that the resource person helped them learn about the technical processes in their business. To operate a business, we also need to think about how we will organize ourselves to do the work.
2. Tell the participants you would like them to think about something they have done with other women, such as plan a celebration or a school event. Ask for several women to talk about how the work was divided up and who decided who did what.
3. Explain that operating a business involves:

<b>Production</b>	Who will do what to make the product or service? What will be our production schedule?
<b>Finance</b>	Who will keep the accounts, and how will profits be shared?
<b>Administration</b>	Who will take care of ordering supplies, filing any required papers, making contracts, and so on?

(Write each item, in words or by symbol, on large paper as you present it.)



4. Talk with participants about these three functions. Answer questions they may have on what is involved in each function. Ask the participants for examples of businesses that are organized in different ways. How does a store owner usually organize her/his business? How is a cooperative organized?
5. Divide the participants into groups of four or five. Ask each group to discuss:  
"How will we organize our business: production, finance, administration?"
6. Take about 15 minutes for the small group discussion. Visit each group during the discussion to clarify issues or provide additional information.
7. Ask one or two people from each group to summarize the discussion. After the reports, pose these questions:  
"For organizing our business, what do we agree on?"  
"What do we disagree about?"  
"What do we need to find out more about?"
8. If the legal requirements of a business do not come up during the discussion, ask the participants:  
"What are the legal requirements for operating a business or cooperative?"  
"How can we find these out?"
9. End the session by reminding the participants that they will seek out more detailed information on business organization in their actual feasibility study.

**Special Note:**

The second activity in Step Four, "Finding Examples of Business Costs" involves a "field trip." Make arrangements for the visit, particularly transportation, well in advance of the meeting.



**Notes:**

## Step Four: Calculate Business Expenses

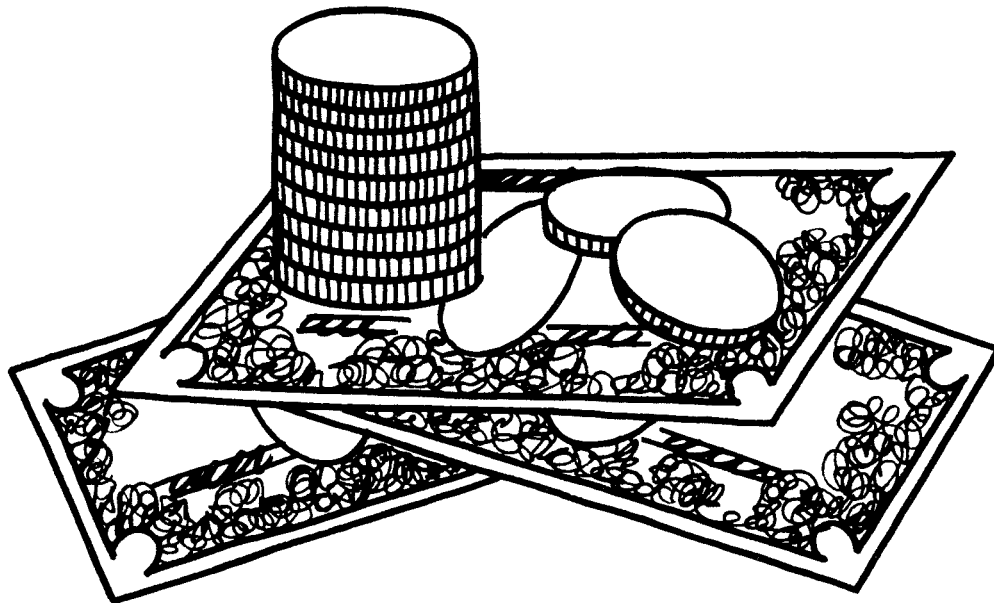

4

# Types of Business Costs

**Purpose:** To introduce participants to the kinds of costs they will have in their business.

NOTE: For existing businesses, use this activity to review current expenses.

**Time:** 1 hour and 30 minutes.

**Rationale:** In planning a business, some costs are obvious and others are more “hidden.” For example, participants may think of supplies they need to purchase but not include the cost of training to improve their skills. This activity presents eight categories of expenses the participants need to consider for their own business.

## Preparation for the Session:

### Materials:

8 “Business Cost” posters  
(see pp. 65-82 for samples)

1. Before the session, review the sample “Business Cost” posters. If you think your participants will understand these symbols, use these posters (or copies of them) in your meeting. If not, have a local artist draw symbols that are appropriate for your group.
2. Read the sample questions on p. 65.

## Steps:

1. Put up the poster for Step Four. Explain to the participants that they will now learn about business expenses.
2. Ask the women to think again about the poster story. What expenses did the woman think about for producing her second product?
3. Have the participants think about another example. Ask them:

“If you were starting a new cooking business and people would come to buy your cooked food, what are all the things you would need to spend money on?”

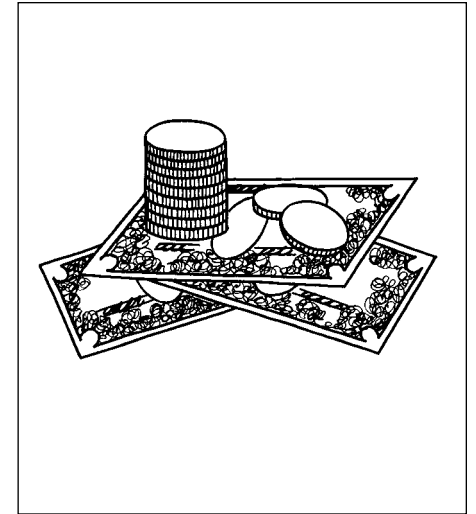

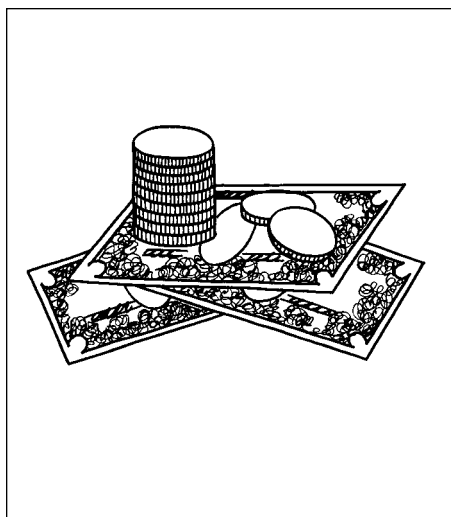

4. Discuss the question for about 10 minutes. Suggest these things if the participants do not mention them:
  - Food, cooking pots, fuel to cook food, bowls to eat with.
  - Animals or vehicle to go and buy the food.
  - Cooking area, electricity or fuel, perhaps a market stall.
  - Wages for people who help in the cooking.
  - Training for additional helpers to do the cooking.
  - Containers for the food.
  - Posters that advertise the cooking business.
5. Now, explain that the business costs they have identified can be grouped into eight types. Present and put up the eight posters one by one.
6. Now, divide the women into teams of three. Tell the teams to prepare one or two minute pantomimes to act out the posters. For example, the team with “transportation” might pantomime a bus. Assign the posters to each team (some teams may have more than one), but do not let the other teams know.
7. Ask each team to present its pantomime—and the other teams to guess what poster they are presenting.
8. After the pantomimes, use the posters again. Discuss each poster one by one. For each poster, ask:

“What are the questions you need to ask to find out your costs?”  
(See p. 65 for examples of questions.)
9. As the women give their ideas, write the questions down for future use.

NOTE: It is important for the facilitator to keep a record of these questions even if the participants can’t read and write.
10. End the activity by explaining that the next session involves a trip into the community to look for examples of business costs.

# Sample Posters and Questions

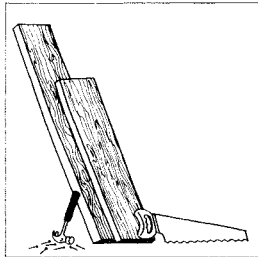

## MATERIALS:

- What materials do you need to start a business?
- How would you find this out if you don't know?
- Where would you get the materials?

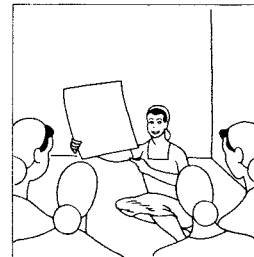

## TRAINING:

- What skills do you need? How will you learn them, if you don't have them already?

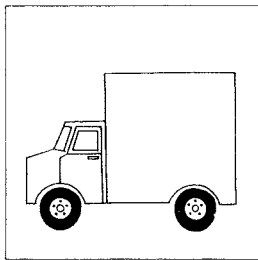

## TRANSPORTATION:

- What transportation do you need to get supplies and to sell your product?

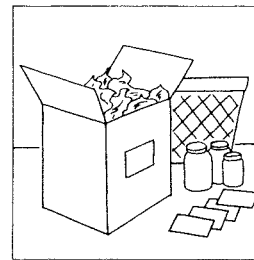

## PACKAGING:

- Does the business require packaging? What kind? Where will the materials come from?

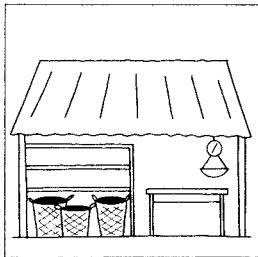

## FACILITIES:

- Where will your business be?
- Do you need electricity, water or other resources?



## PROMOTION:

- How will you advertise your business?



## WORKERS:

- Who will do the work?
- How much is our time worth?
- Do you need to hire other workers?

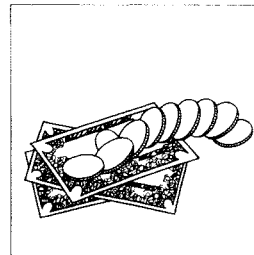

## MONEY:

- Where will you find loans or grants to start and operate your business?
- How much are the interest payments?



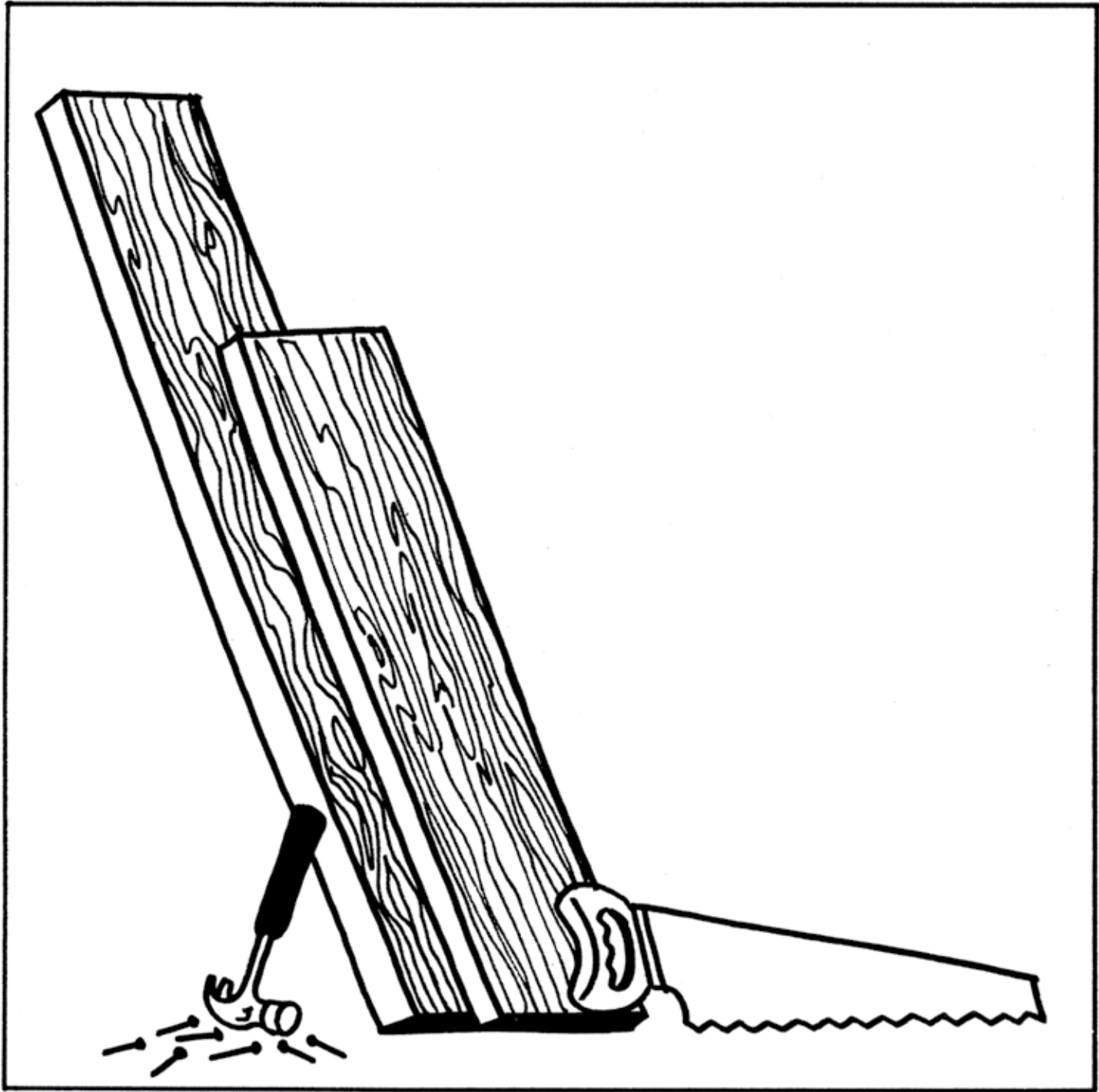





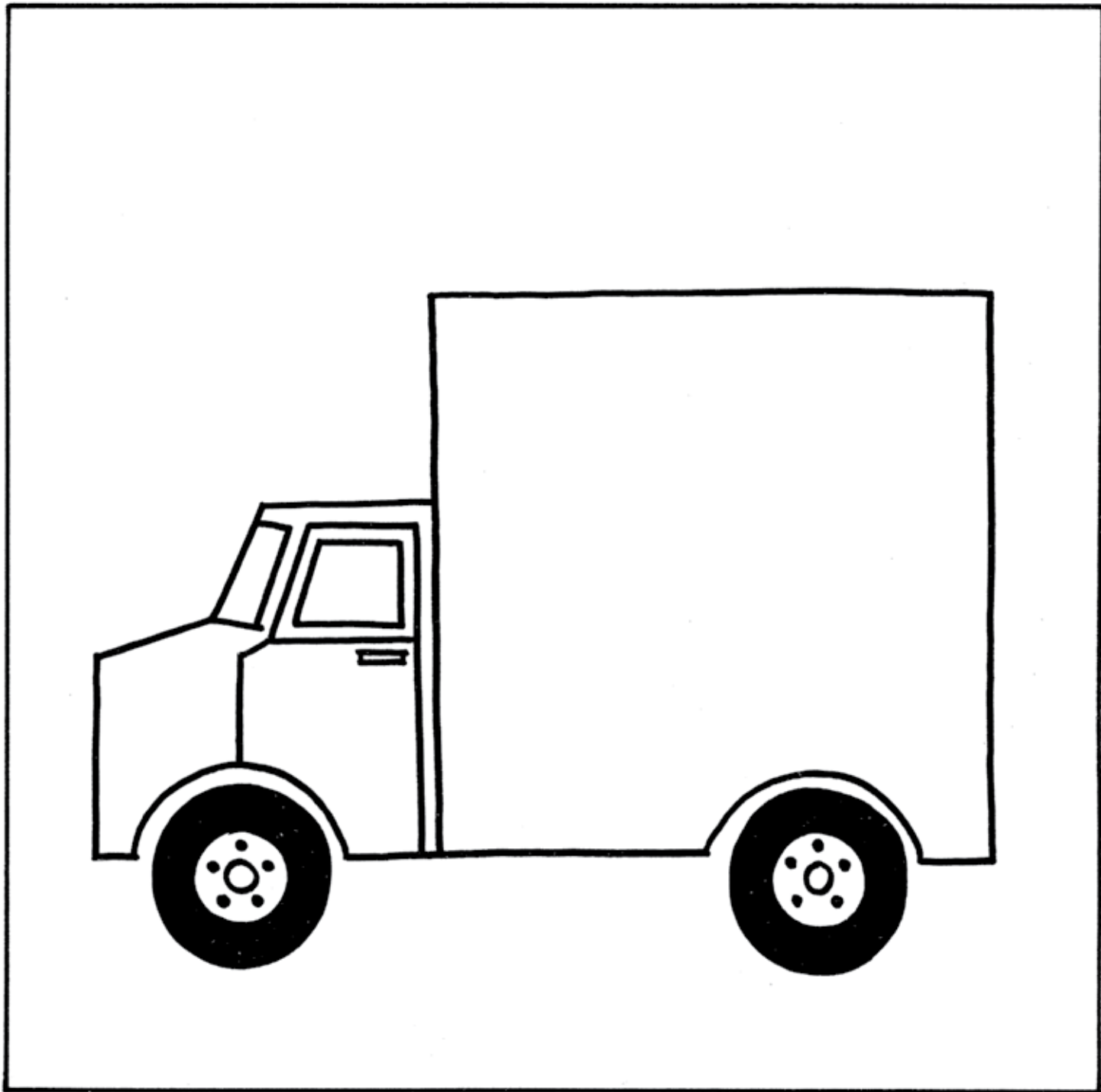



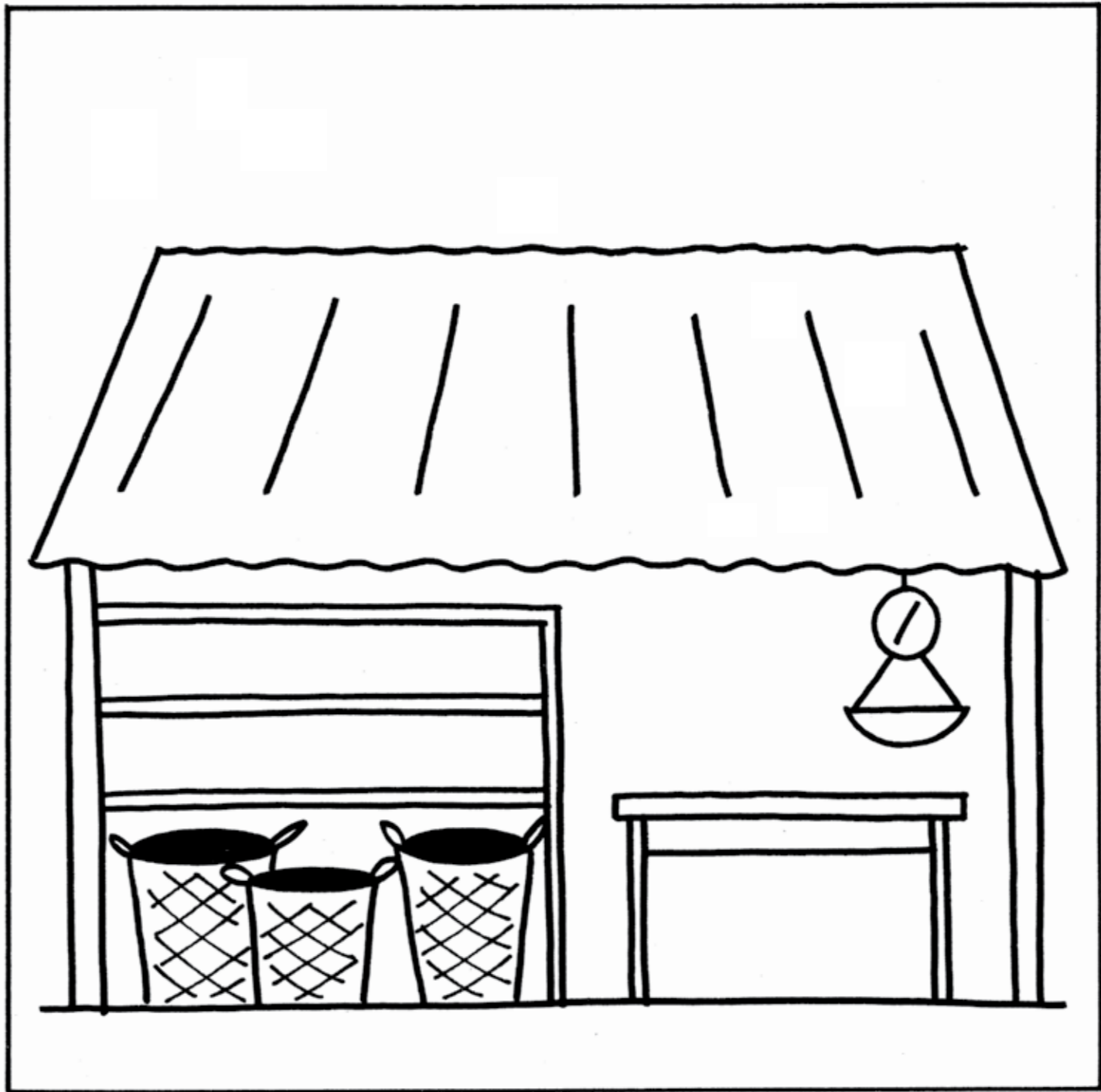







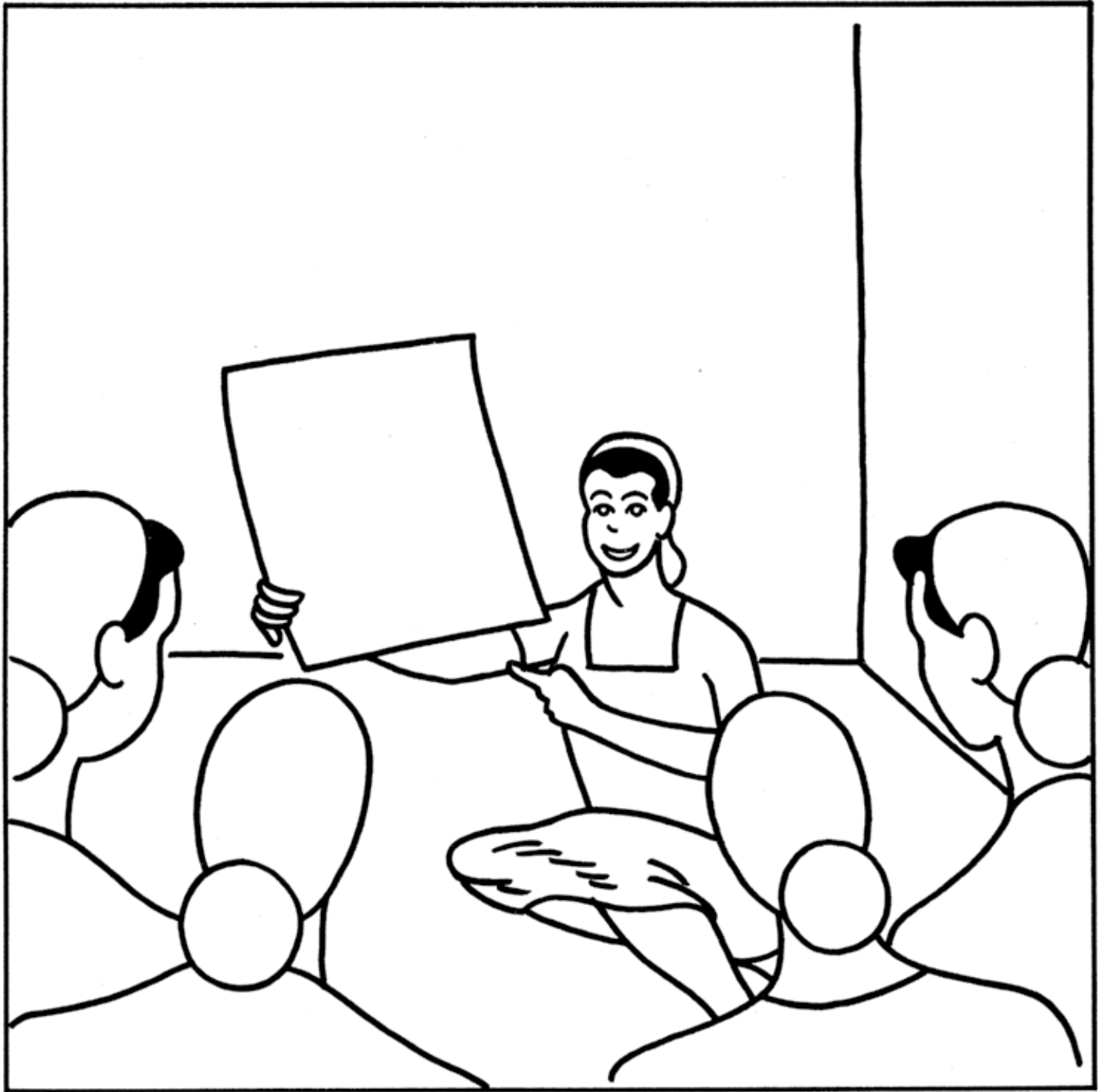





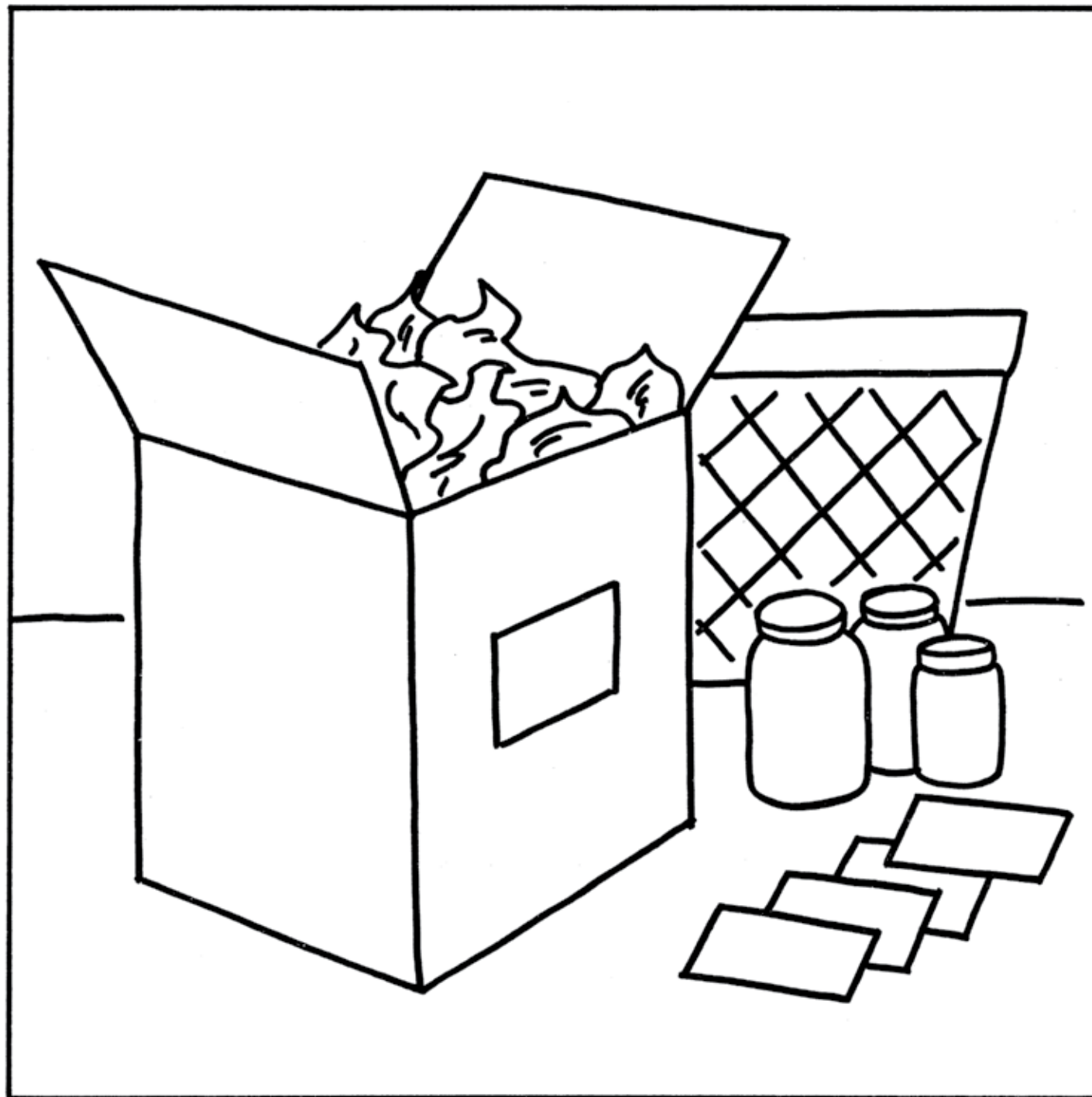



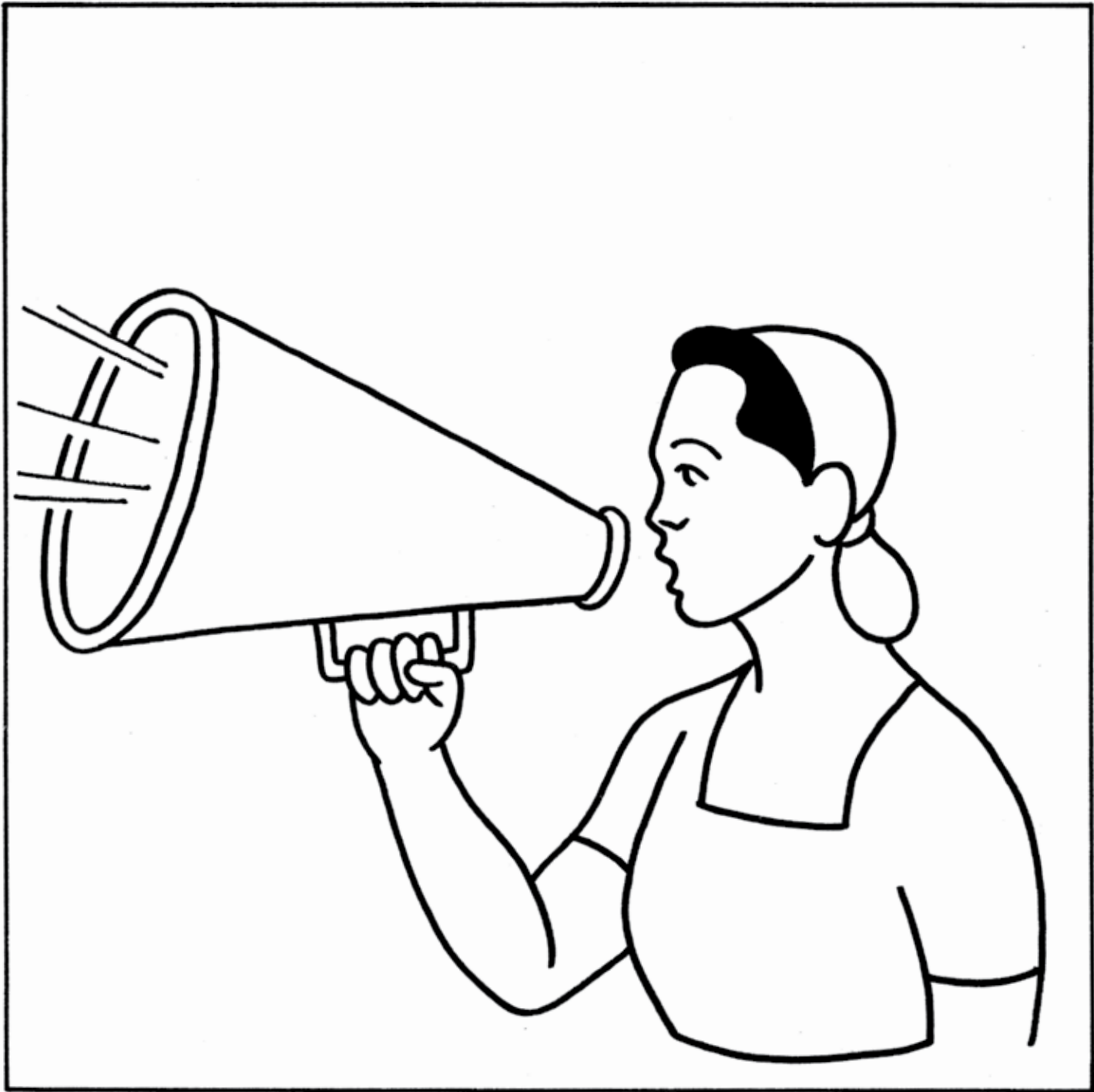



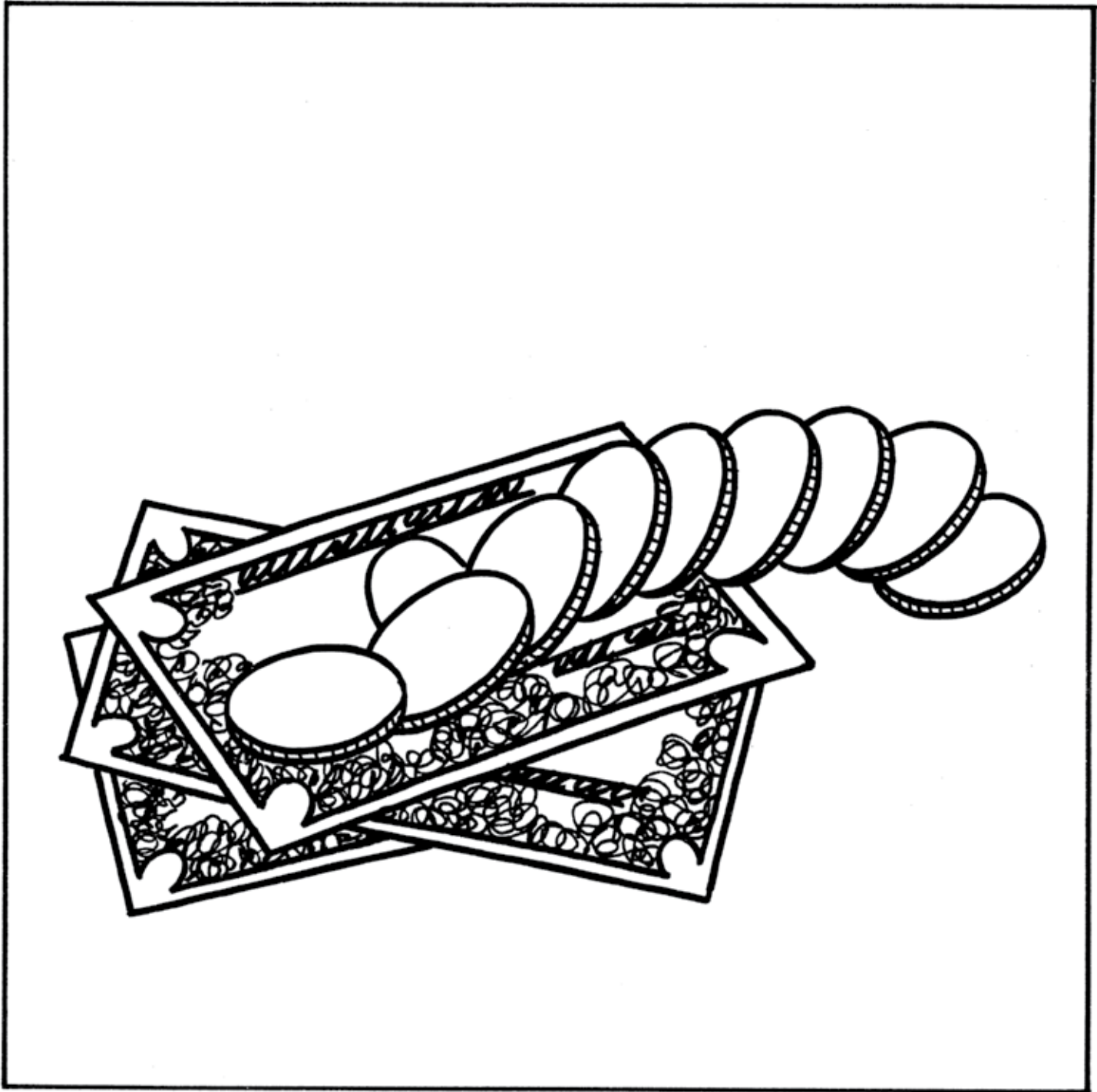



# Finding Examples of Business Costs

**Purpose:** To enable participants to identify some of the actual expenses in their business.

NOTE: This activity can be omitted for existing businesses or used to identify ways to reduce expenses.

**Time:** 3-4 hours.

**Rationale:** This activity makes the eight types of business costs “real” rather than “abstract.” Going into the community and finding examples of expenses helps the participants remember the cost categories. It also enables them to identify different options for a particular expense, such as different means of transportation.

## Preparation for the Session:

### Materials:

One or more Polaroid cameras and film (if not available, give each participant a paper and pencil for drawing)

1. Make arrangements for the community visit. Choose a place or places to visit where participants can find examples of expenses for the business they are studying.
2. The Polaroid camera is used for taking pictures of the examples of business expenses. This gives participants a visual record of what they find. If a camera is not available, have participants draw pictures of what they see.
3. Be sure to allow at least 30 minutes for discussion before the trip and an hour for discussion after the trip. If this is too much for one day, have the post-trip discussion the next day!

## Steps:

1. Before the trip, meet somewhere with the participants where you can have a 30 minute discussion.
2. Ask the participants to name the eight types of costs. Tell them that the purpose of the trip is to find examples of costs for the business idea they chose.

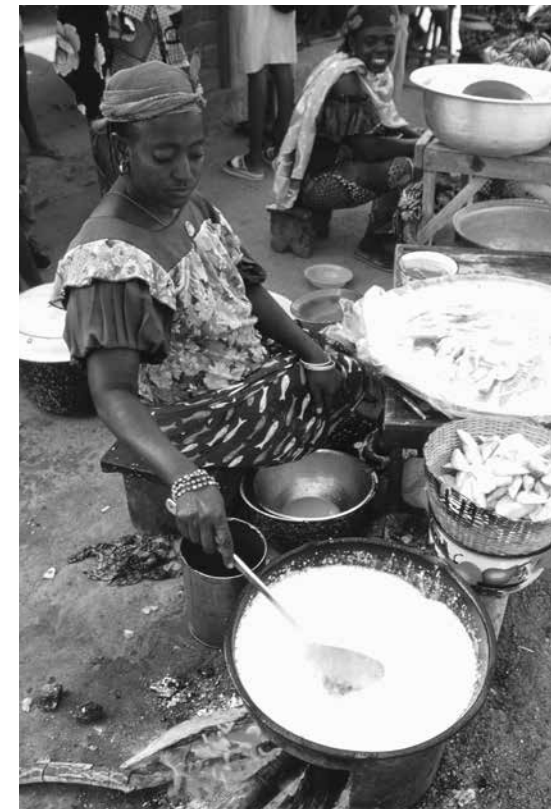
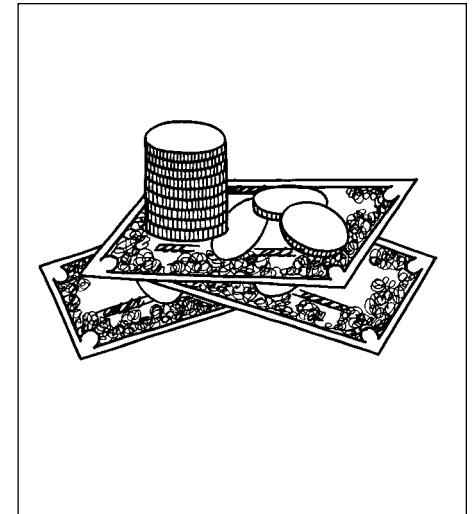

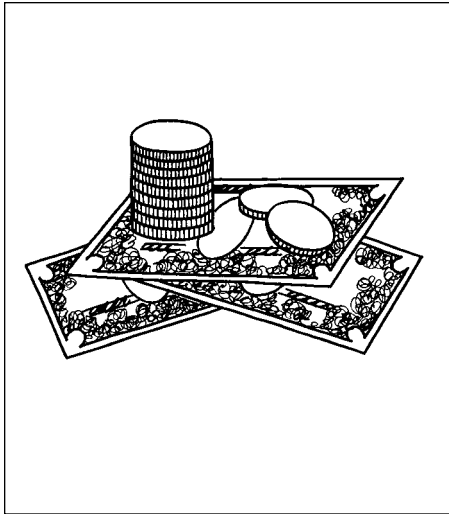

3. Divide the group into teams of five. Explain:

“Each group should find one example of all eight of the cost categories and photograph (or draw) it. Each team will take (or draw) eight pictures. The members must decide among themselves which pictures to take (or draw). If a type of cost does not apply to your business, find an example for another business.”

NOTE: If using a camera, encourage the teams to allow each woman to have a turn taking a picture.

Ask if there are any questions.

4. Show the women how to use the camera and let them practice.

5. Give the women a few minutes to meet in teams before leaving.

6. Arrange a time and place for all the teams to meet after they are finished taking or drawing the pictures. If you have only one camera, work out a way to share it.

7. Go on the “field trip.”

8. After the trip, meet with the women for about one hour.  
Ask:

“Will each team show your photographs and describe why you selected them?”

“How did you, as a team, decide which photographs to take?”

“What new ideas do you have about costs for your business?”





# What Do We Need to Buy? How Much Will it Cost?

**Purpose:** To enable the participants to decide the specific needs of their business for each of the eight types of business costs.

NOTE: Existing businesses can use this activity to review costs or determine ways to reduce costs.

**Time:** 1 hour and 30 minutes—2 hours.

**Rationale:** The financial calculations for the participants' planned business begin in this activity. They figure what they need to start and to operate the business and how much it will cost. They must know this to be able to determine if the business can be profitable.

## Preparation for the Session:

### Materials:

8 "Business Cost" posters (pp. 65-82)

Large paper and felt tip pen

Charts for "start-up" and "operating" expenses (see pp. 86-87)

1. Read this activity carefully and practice using the charts to calculate costs for a business with which you are familiar.
2. Think about the expenses that will be involved in the participants' planned business. Estimate the price of specific items, so you will be prepared to help the participants with the calculations.
3. Participants who cannot read and write may have some difficulty with the financial calculations. Schedule "breaks" so they do not become tired, and provide lots of encouragement!

## Steps:

1. Put up the eight "cost" posters. Once again review the eight types of business costs. Tell the women that they will determine the costs for their business idea in this activity. Remind them that much of this will be guessing at costs and not to worry if they do not have exact figures. The main purpose of the activity is to learn how to calculate costs for their full study.
2. Ask the women to remember the poster story. For the second product, how did the woman decide her business costs?
3. Remind participants that she first decided what she needed to start the business and then decided what she needed to operate it. They will do the same thing.
4. Put up the chart for "start-up" expenses:

**Notes:**

# Start-Up Expenses

RESOURCES	WHAT WE NEED	WHERE WE CAN GET IT	HOW MUCH IT WILL COST
• Materials	-----	-----	-----
• Transportation	-----	-----	-----
• Facilities	-----	-----	-----
• Workers	-----	-----	-----
• Workers' Training	-----	-----	-----
• Packaging	-----	-----	-----
• Promotion	-----	-----	-----
		TOTAL:	-----

5. Ask participants to decide what they will need to begin the business. For each type of cost, decide:

- What do we need? And, how much?
- Where can we get it?\*
- How much will it cost?

\* Participants may want to contribute something, such as a bucket, to the business so that they can lower costs. Even if they do not have to buy a particular item, help them understand that it has value and it is part of their business investment.

6. Write the answers (in words or symbols) on the chart and calculate the total start-up expenses.

7. Now, ask the participants to determine the cost to operate the business. Ask them:

“How many items will you make in one production cycle?”

(Reminder: A “production cycle” is the period of time needed for producing one “batch” of items.)

8. Then, use the chart to calculate the costs: first, for one production cycle and second, for one year of operation.

NOTE: Participants should count their labor as an expense. Have them estimate an hourly wage and then multiply that by the number of hours worked.

# Operating Expenses

RESOURCES	WHAT WE NEED	WHERE WE CAN GET IT	HOW MUCH IT WILL COST FOR ONE CYCLE	HOW MUCH IT WILL COST FOR ONE YEAR*
• Materials	_____	_____	_____	_____
• Transportation	_____	_____	_____	_____
• Facilities	_____	_____	_____	_____
• Workers	_____	_____	_____	_____
• Workers' Training	_____	_____	_____	_____
• Packaging	_____	_____	_____	_____
• Promotion	_____	_____	_____	_____
• Loan Payments	_____	_____	_____	_____
			TOTALS:	_____

(\*Yearly Costs = Cost of one cycle multiplied by number of cycles in a year.)

- Complete the Operating Expense chart.
- Tell the participants that besides calculating "start-up" expenses and "operating" expenses, it is a good idea to plan a small reserve fund for repairs, replacements, or unplanned expenses. Discuss how much they think they need as a "reserve" for their business.  
NOTE: In business terms, their "reserve" can be considered a "depreciation allowance."
- Now, point to the "Money" poster. Ask the group to think about the money they have for the business:
  - "What money do you have? How much might you need to borrow to start the business and begin operating?"
  - "Where can you get a loan, if needed?"
  - "What will the interest be? (Tell participants that loan payments on principal and interest need to be included in "expenses.")"
- Save the charts and loan information. They will be needed in Step Six.
- To end the session, congratulate the group on all its hard work!

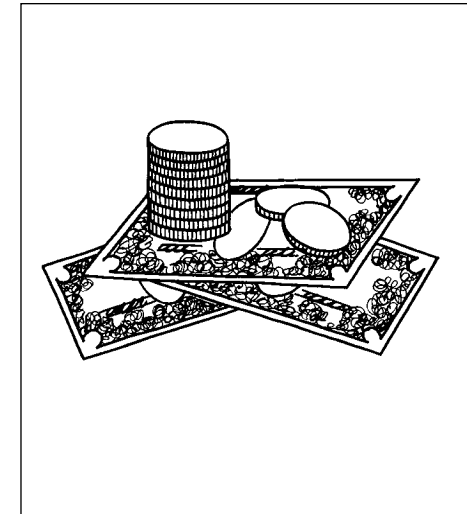

# Step Five: Estimate Sales Income

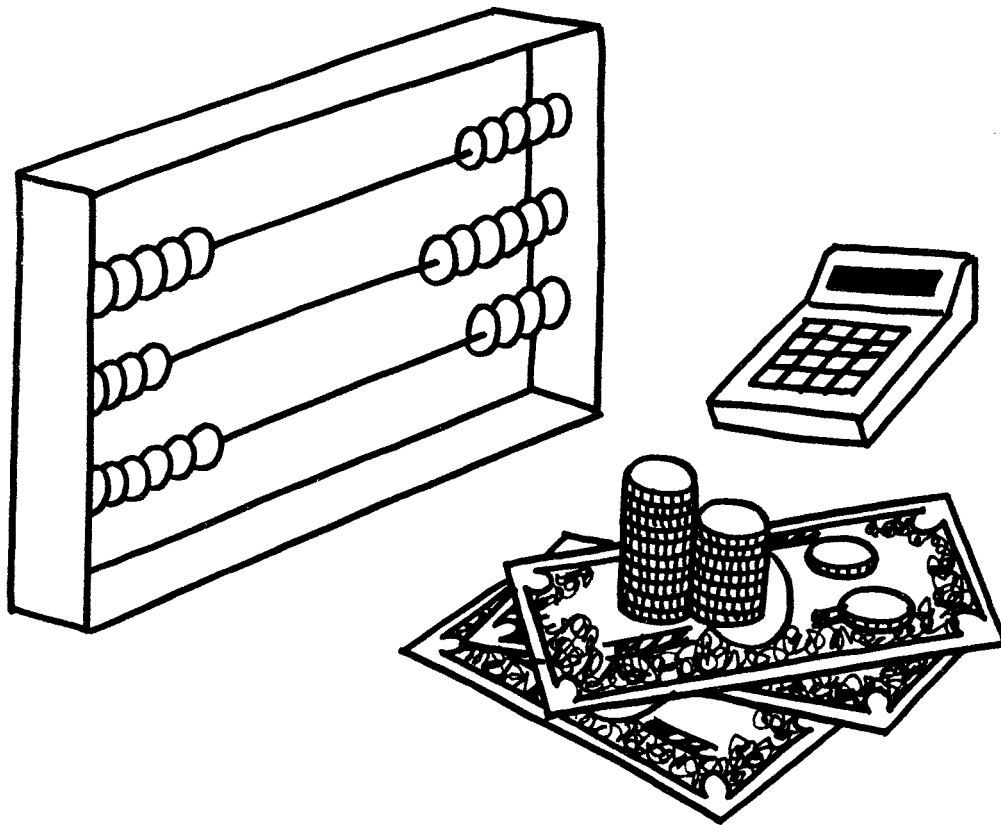

5

# Selling a Product or Service

**Purpose:** To introduce participants to the kinds of decisions they need to make related to selling their product or service.

NOTE: Existing businesses can use this activity to identify gaps or problems in their sales practices.

**Time:** 1 hour and 30 minutes.

**Rationale:** The participants have already thought about production and business operation. Careful attention also needs to be given to sales. In most cases, businesses have options regarding how much to sell, what price, when and where. These decisions greatly affect sales income. This activity raises issues about sales decisions for the women to consider in planning their own business.

## Preparation for the Session:

### Materials:

"Rhoda's Story" and "Zenab's Story" (see pp. 90-91)  
"The Cloth Seller" instructions (see p. 92)

1. Prepare the play about a woman who buys and sells cloth (see instructions on p. 92).

### Steps:

1. Show the Step Five poster. Explain that this activity presents decisions that need to be made for selling a product or service.
2. Tell the women this story is about Rhoda, a woman like them who had her own business.
3. Read the story.



## “RHODA’S STORY”

One day Rhoda decided to sell vegetables at the market like her other friends. With 50 coins in savings, she bought 50 potatoes from a nearby farm for one coin each. She decided to sell the potatoes for two coins each.

She found an empty table and placed her potatoes for people to buy. Her friends told her the man, who owned the stall tables, would come to collect in the afternoon. She thought she would sell all her potatoes and pay the man from the profit of 100 coins.

By the afternoon, Rhoda had sold all her potatoes. Her price of two coins each was so inexpensive that all the people wanted to buy from her. She had 100 coins from her sales.

Then the man came to collect for the stall table and told her the cost was 100 coins. “That is all that I earned today!” said Rhoda.

She had to give him the 100 coins and went home without any money. She had lost the 50 coins from her savings and she lost the 50 coins she had earned.

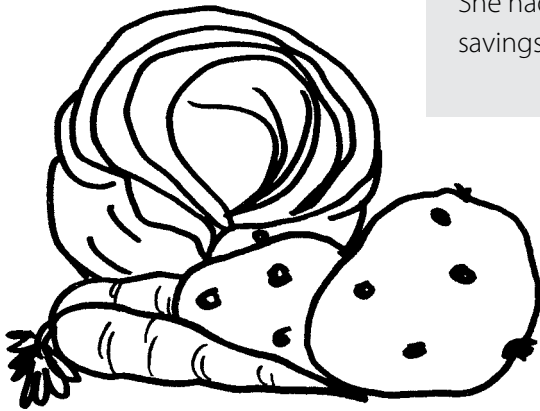

4. After telling the story, ask the women:

“What was Rhoda’s problem?”

“What should she have done?”

“What would have happened if Rhoda priced her potatoes at three coins each?”

“What would have happened if the man had asked 150 coins for the table?”

“What things did Rhoda need to think about when she began her business?”

If the women do not come up with these ideas, suggest:

How many potatoes to buy; how many potatoes she might sell; what other costs she would have; the price of other sellers' potatoes.

5. Read Zenab's story.

## "ZENAB'S STORY"

Zenab decided she wanted to sell some fruit. She asked herself: What does it cost to get started in a fruit business? She went to the farmer and asked what it would cost to buy 50 pieces of fruit. Then she went to the man with the stall tables and asked how much it would cost for a table for one day.

Finally, she went to the market and visited other fruit sellers to see what kinds of fruit they had and how much they charged for each piece. She now had enough information to answer the question: What will my costs be?

Now she thought about: What shall I sell the fruit for? How much can I sell in one day? She went back to the market. She stood near the fruit tables and counted the people who passed. Then she counted how many people bought the fruit. She decided that people would buy her fruit if she sold it at the market.

She went home and wrote down her costs and possible income. She figured out how many pieces of fruit she would have to sell at what price to make a profit.

The next day she bought her fruit and started her business.

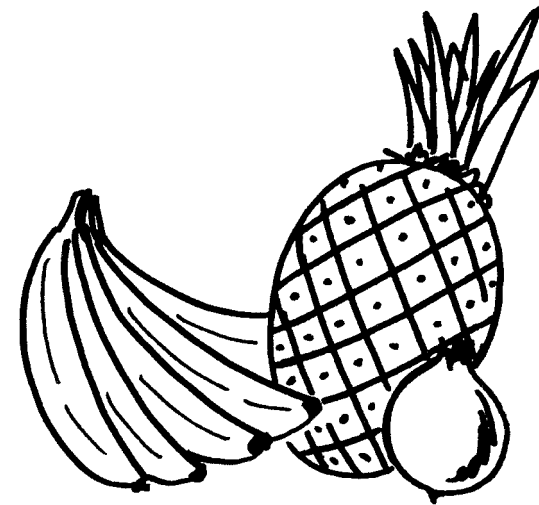
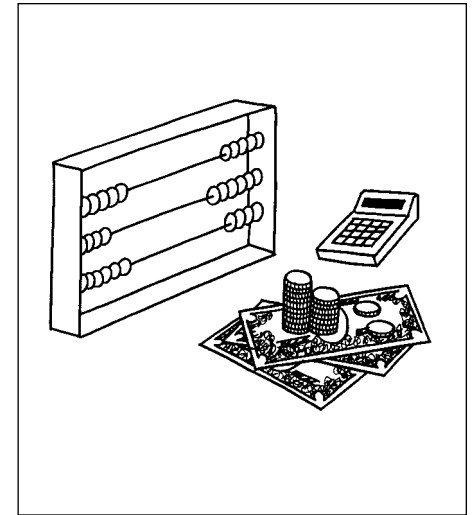

6. Ask the women to discuss:

“What is different about Zenab and Rhoda?”

“Is Zenab likely to be more successful than Rhoda? Why, or why not?”

“What decisions did Zenab make before selling fruit?”

“What did you learn from Rhoda and Zenab that is important to think about for selling your product or service?”

7. Now present the play about the woman who buys and sells cloth.

8. After the play, ask the group:

“How much did the woman pay for each piece of cloth? How much in total? Did she have any money left?”

“How much did she sell the cloth for?” “How much was her profit?”

9. Next, ask the participants how much the woman really made:

“What were her expenses?” (Examples: transportation to buy the cloth, hours of her time to buy and sell, and rent on the market stall.)

“How much do these expenses cost?”

“Subtract these costs from the sales price of the cloth. Compare this amount to the amount she paid for the cloth.”

“Did the woman make money or lose money?”

10. To end, ask the participants:

“How could the woman have made a profit (or more of a profit)?”

Discuss ways to reduce expenses, or the need to find another business.

## INSTRUCTIONS

# “The Cloth Seller”

In this drama, a business woman will buy some cloth from a seller and then sell the cloth at her market stall. Two women customers come to buy.

The four actors in the drama are:

**A Cloth Seller**, who has two pieces of cloth to sell. She can charge no more than 3 coins for each piece.

**A Business Woman**, who has 6 coins. She must buy some cloth and decide how much to charge for each piece when she sells it at her market stall.

**Two Customers**, who have 4 coins each to buy some cloth.

The drama proceeds like this:

The Cloth Seller decides how much she will charge for each piece of cloth (no more than 3 coins each).

The Business Woman then goes to the cloth seller to buy the cloth. She can bargain with the cloth seller if that is the custom in your country.

The Business Woman then goes to the market stall and tries to sell her pieces of cloth.

Two customers come up to examine and buy some of her cloth. When the buying is finished, the drama is ended.

NOTE: At any time, the women watching the drama may give suggestions on pricing.



# How Much Can We Sell, and For How Much?

**Purpose:** To enable participants to project sales income for their business idea.

NOTE: For existing businesses, use this activity to reassess current prices and competition.

**Time:** 2 hours.

**Rationale:** The Step Four activity, “What Do We Need to Buy? How Much Will It Cost?,” involved the women in calculating their business expenses. This activity presents the next financial calculation in studying a business, estimating sales income. In the activity, participants set a price for their product or service and project income on a daily, weekly, and monthly basis.

## Preparation for the Session:

### Materials:

Price and Competition posters (see pp. 97 and 99 for samples)

“Cost-Plus-Profit Chart” and “Sales Chart” drawn on large paper (see pp. 94-95)

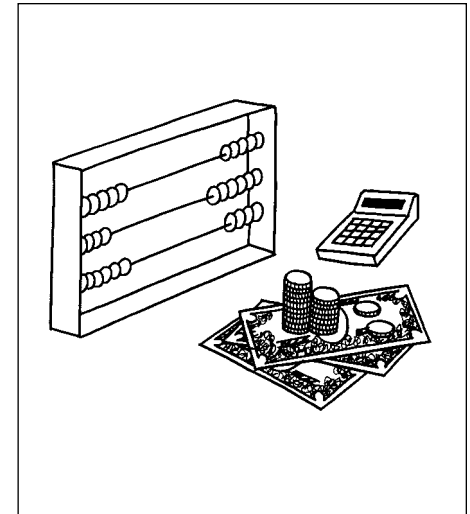

1. Before the session, look at the “price” and “competition” sample posters. If you think your participants will understand the symbols, use these posters (or copies of them) in your meeting. If not, have a local artist draw symbols that are appropriate for your group.
2. Practice completing the “Cost-Plus-Profit Chart” and “Sales Chart” for a product with which you are familiar. Think about the price participants might set for their item, based on what you know about existing prices or what you think people would be willing to pay. Be realistic.
3. Provide “breaks” and encouragement so participants do not become discouraged by the financial calculations.

## Steps:

1. Tell participants that estimating sales is the risky part of a business. It is possible to determine costs fairly exactly. But, the volume of sales will always be an estimate. This activity will help them be realistic about their projected sales. If we overestimate sales, we may choose a business that is not actually profitable.
2. Put up the two posters, for “price” and “competition”. Remind the women that they used eight posters to estimate their business costs. These two new posters show things we must think about to estimate how much we can sell: price and competition.

3. Point to the price poster. Explain that setting the price of a product should be a very careful decision. Ask:

"How much money will you charge for one of the items you plan to sell?" (For example, how much would one potato cost?)

"How did you decide this price?"

"Can customers pay this amount?"

4. Tell participants that "Cost-Plus-Profit" is a method many businesses use to determine price. Use the chart to help participants set their price:

5. Take a break.

6. Now, show the next poster on "Competition." Point out that it is essential to know our competition for estimating our sales income.

Discuss:

"Who are your competitors?"

"What do you know about them?"

"How much do they charge for an item?"

"How much do they sell each day? (each week? each month?)"

"Did you consider this price when you set your price?"

"If your price is:

(1) higher than the competitor: why do you think people will buy from you?

(2) lower than the competitor: will you be able to make a profit?"

7. Ask the participants if they want to change their price. Have them agree on a sales price.

(Remind them that this is a guess, and that during the full study they will have more information on which to base their decision.)

### **COST-PLUS-PROFIT = PRICE**

1. List monthly costs:

Materials \_\_\_\_\_

Transportation \_\_\_\_\_

Facilities \_\_\_\_\_

Labor/Salaries \_\_\_\_\_

Packaging \_\_\_\_\_

Promotion \_\_\_\_\_

Loan Payments/Taxes \_\_\_\_\_

Other \_\_\_\_\_

Total Costs \_\_\_\_\_

2. List the number of items you produce each month \_\_\_\_\_

3. Divide:  $\frac{\text{COSTS (total of \#1)}}{\text{ITEMS (\#2)}} = \text{PER ITEM COST}$

EXAMPLE

Costs:  $\frac{100 \text{ coins per month}}{20 \text{ items}} = 5 \text{ coins per item}$

4. Discuss: How much do I add to each item's cost for my profit? What is a reasonable amount to add as profit? How will I know if this is reasonable?

NOTE: Market tests are a good way to find out what customers are willing to pay.

5. Add the PER ITEM COST and the PROFIT MARGIN for each item and you have your SALES PRICE for each item. EXAMPLE: 5 coins + 1 coin = 6 coins per item





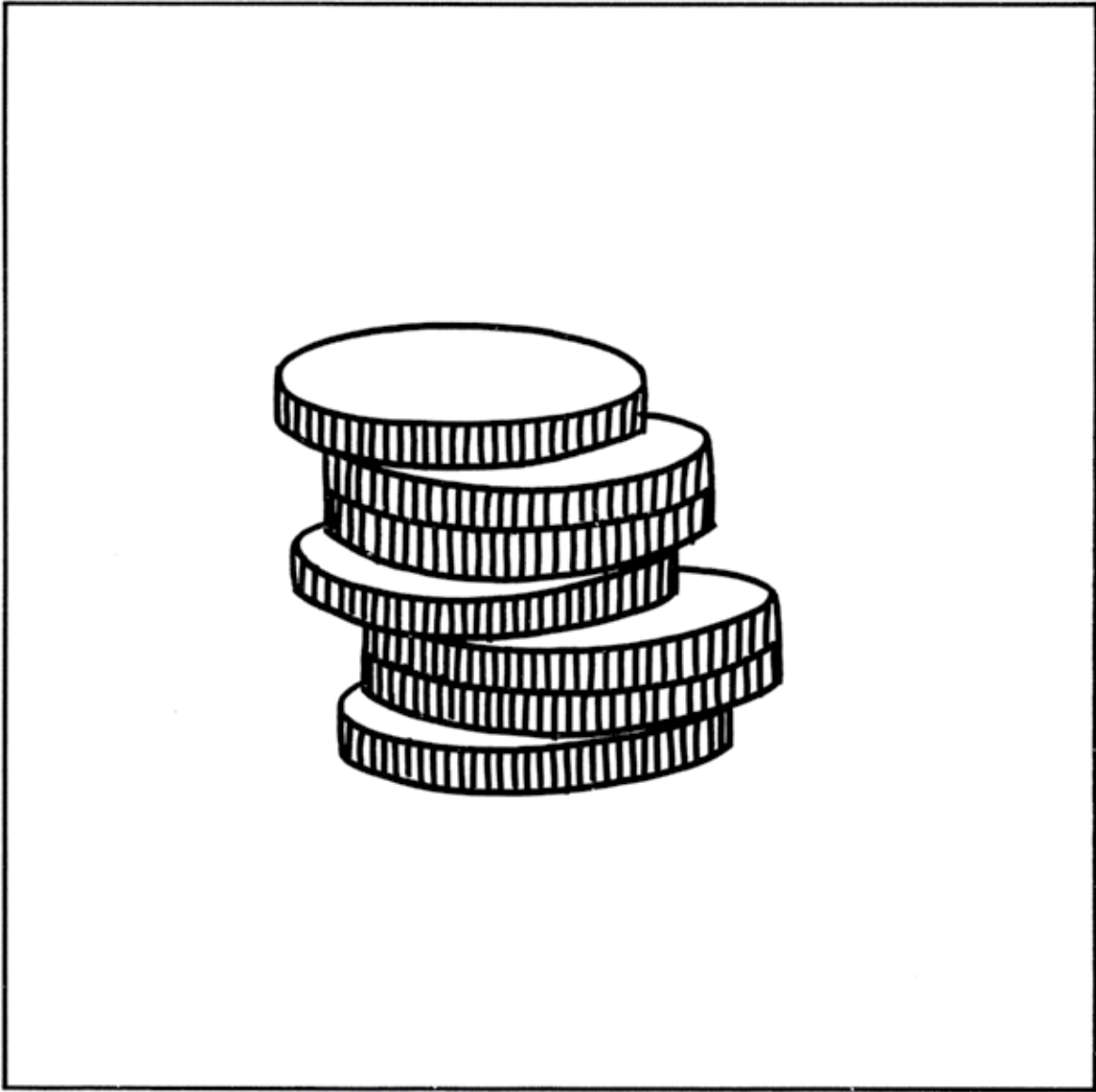



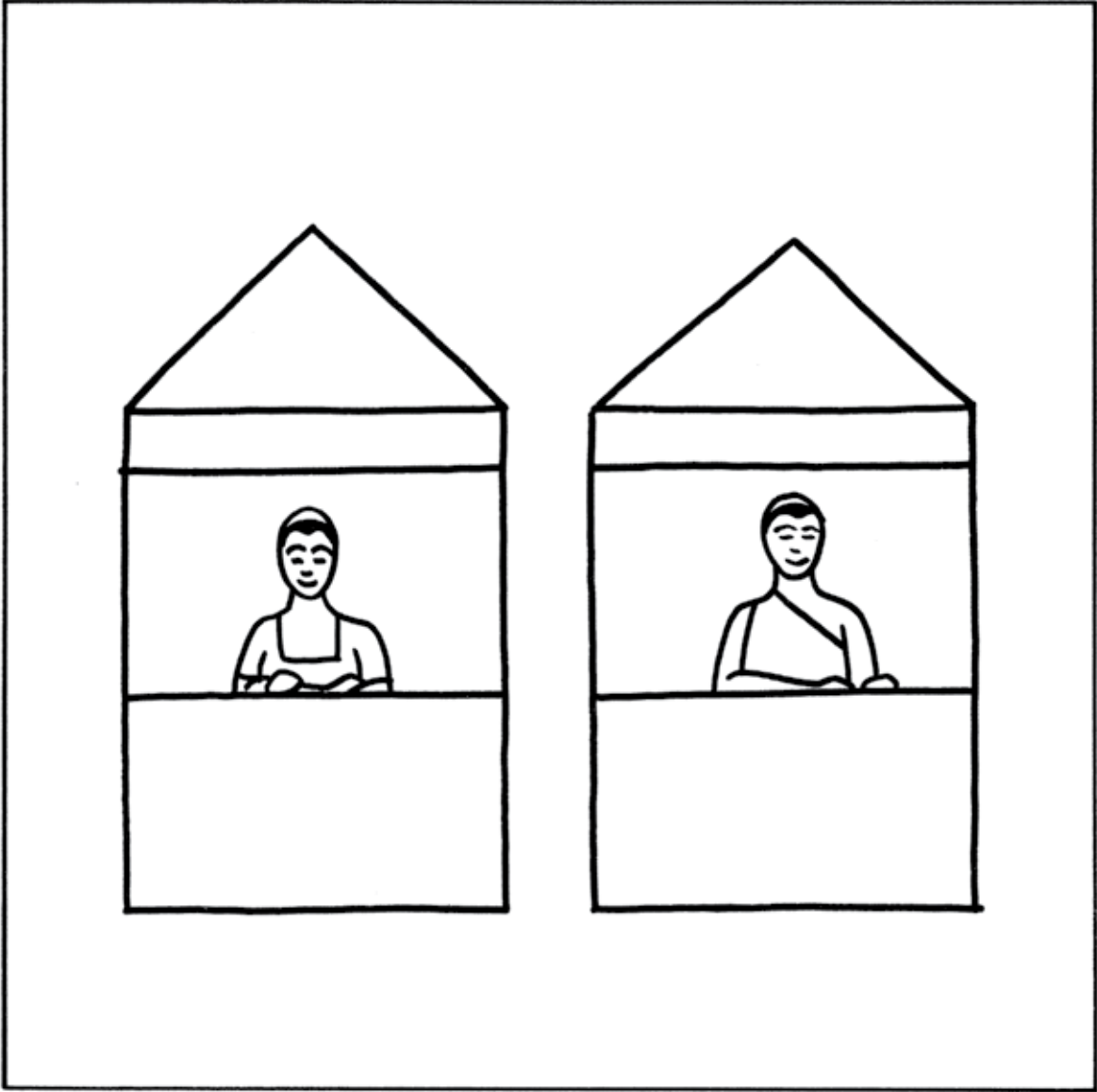

COMPETITION





# Step Six: Decide: Is the Business a Good Idea?



6

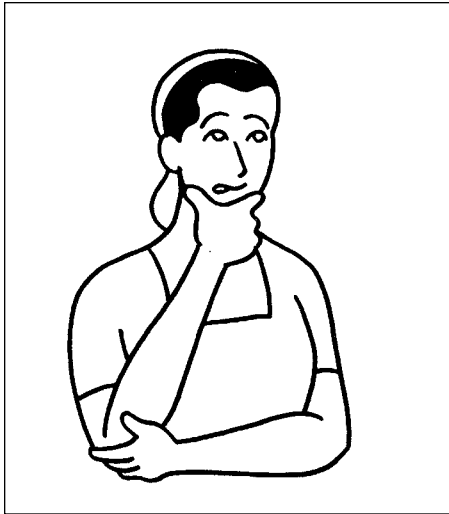

# How to Calculate Profit and Cash Flow

**Purpose:** To present the concept of “profit” and how it is determined.

NOTE: If women with existing businesses have a good understanding of “profit” and “cash flow,” this activity can be omitted.

**Time:** 1 hour.

**Rationale:** Women in your program cannot afford to lose money on a business venture. This activity enables them to understand that profit = sales income minus business costs.

## Preparation for the Session:

### Materials:

3 bags of candy with 20 pieces each  
“Poster Story” and posters  
Large paper and felt tip pen  
Blank “cash flow” chart (see p. 107)

## Steps:

1. Show the Step Six poster. Explain that this is the last step in doing a feasibility study. The participants will now determine what benefits they will get from the business and whether it is worth their time and effort.
2. Divide the women into three groups. Give each group a bag of candy. Tell them:  
“Each bag was bought in the nearby town for 100 coins.”  
(Change this amount to fit your locale.)  
“Decide how much you will sell each piece of candy for and how much profit you will make. Give your reasons for the price.”  
“You have 10 minutes to discuss and decide.”

3. Ask each group to report. For each group, write down:

	PRICE	SALES INCOME	EXPENSES	PROFIT
Group 1	_____	_____	_____	_____
Group 2	_____	_____	_____	_____
Group 3	_____	_____	_____	_____

(Check that their calculations are correct.)

4. Discuss:

“Are the figures different or the same? If different, why?”

“Are any of the groups actually losing money? Why?” “What did you learn from the candy exercise?”

NOTE: Make sure the group discusses costs in addition to the 100 coins spent to purchase the candy, such as: transportation, packaging, labor, and so on.

5. Now, present part of the Poster Story again. Read and show the posters for #12-16. Discuss. Answer any questions the women have.

6. Ask them:

“What do you think the women in the story should do with their profits? (at the end of 3 months, 6 months, a year?)”

NOTE: Talk about the importance of saving for emergency expenses and for reinvestment in the business.

7. Explain that besides determining if we can make a profit, we need to determine *when* we will make a profit. We need to know our “cash flow.”\*

8. Tell the story of the couple who want to buy a bed. As you tell the story, write their earnings and expenses on the chart for each month.

\*For a more detailed explanation of “cash flow,” see p. 143

## Can We Buy a Bed?

Rosa, Pablo and their children live together in a small village. They would like to buy a bed which costs 50 coins. They must find out *if* and *when* they will have enough money to buy the bed in the coming year.

### INCOME:

Rosa earns 20 coins by doing ironing work in January, March, June, August, October, and December. Put 20 under the months on the chart.

In May and September, Pablo gets paid 50 coins for his vegetable crops. Put 50 under May and September.

### EXPENSES:

Rosa and Pablo estimate that they need 10 coins every month for their expenses. Put these on the chart each month.

Now add up the expenses (10 coins per month) for the entire year (120 coins).

Subtract the expenses (120) from the income (220), which will show that they have 100 coins profit for the year.

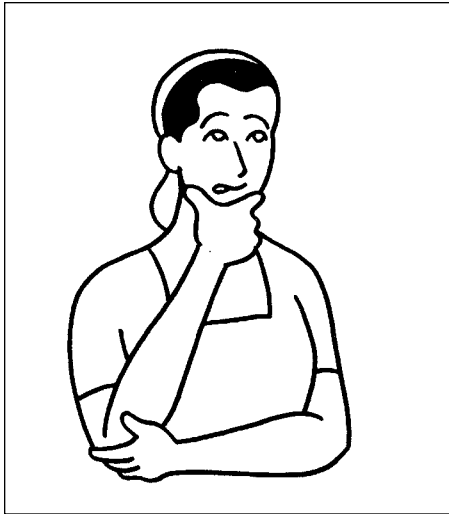

9. Ask:

Can Rosa and Pablo buy the bed? (yes)

When?

Help the participants calculate how much Rosa and Pablo have left each month.

Should they buy the bed in June? August? September? Why or why not?

If they buy the bed in June, they will not have enough money for July expenses. If they buy the bed in August, they will use up all their money. Discuss the importance of keeping some money for unplanned expenses or emergencies.

10. To end, pose this problem:

“You have a friend who has decided to sell eggs at the market. She wants to make sure she does not lose money. How would you explain to her how to calculate profit?”

**REMEMBER: Sales Income minus Business Expenses = PROFIT**

### CASH FLOW

MONTHS	JAN.	FEB.	MAR.	APR.	MAY	JUNE	JULY	AUG.	SEPT.	OCT.	NOV.	DEC.	TOTAL
<b>SALES INCOME</b>	20		20		50	20		20	50	20		20	220
<b>EXPENSES</b>	10	10	10	10	10	10	10	10	10	10	10	10	120
<b>ACCUMULATED PROFIT OR LOSS</b>	10	0	10	0	40	50	40	50	90	100	90	100	100

NOTE: This is the form with the answers. Use a blank chart in your activity and write in the numbers as you tell the story.

## CASH FLOW CHART

MONTHS	Jan.	Feb.	Mar.	Apr.	May	June	July	Aug.	Sept.	Oct.	Nov.	Dec.	TOTAL
SALES INCOME													
EXPENSES													
ACCUM. PROFIT OR LOSS													



# What Will Our Profit Be?

**Purpose:** To calculate the projected profits for the participants' business idea.

NOTE: With existing businesses, use this to project profits for one to three years.

**Time:** 1 hour.

**Rationale:** This activity uses the earlier calculations on business expenses and sales income to determine possible profit. This calculation is what businesses call the "bottom line." A business must be profitable, unless it is supported by subsidies.

## Preparation for the Session:

### Materials:

"Profit Chart" below

"Start-Up Expenses" and "Operating Expenses" Charts from Step Four

"Sales Income" Chart from Step Five

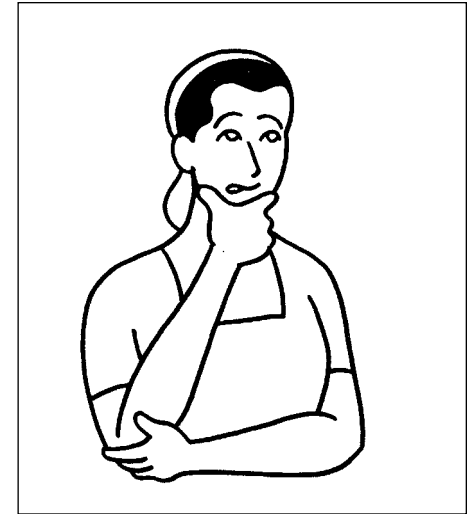

## Steps:

1. Tell the participants that the purpose of this activity is to predict whether they can make a profit in their proposed business.
2. Put up the previous three charts on expenses and income, and the "Profit Chart."

<b>PROFIT CHART</b>			
	<b>YEAR ONE</b>	<b>YEAR TWO</b>	<b>YEAR THREE</b>
Sales Income	_____	_____	_____
Expenses	_____	_____	_____
Profits	_____	_____	_____

## EXPENSES

3. The first information to put on the chart is the costs for their business idea. Show them the “start up expenses” and “operating expenses” charts they developed in the last activity of Step Four on costs. Put this information on the Profit Chart. “Start up expenses” should be included in Year One costs.  
If the women plan to borrow money to start a business, the loan payments (principal and interest) must then be added in. If the women are using their own money to start, help them calculate how long it will take to pay back this investment.

## INCOME

4. Now, present the “Sales Chart” information from Step Five. Put these amounts on the “Profit” chart.

## PROFITS

5. Subtract the expenses from the sales income on the chart to find the profits. Now ask the women:

“Does the business show a profit? When?”

“If there is a loss, is there a way to make the business profitable?”

Here are some ideas to discuss:

- Borrow money to cover some costs
- Sell more products
- Sell each product for a higher price.

“Is the business a good idea in terms of the money you can make?”

**SPECIAL NOTE:** Your participants may be discouraged if they do not see an immediate profit. However, some good business ideas may take longer to make a profit, especially if you have big costs at the very beginning.

For example, you might have to buy a large amount of cloth in order to make dresses to sell. The cloth is much cheaper if you buy a large amount. But, it might take longer than a year to make and sell all the dresses from the cloth. Therefore, it would take more than a year to make a profit. In the real feasibility study, participants will calculate more closely how much the expenses and sales income will be each month.



# What Other Benefits Are Important?

**Purpose:** To discuss other gains from the business, for participants, their families, and communities.

**Time:** 30 minutes.

**Rationale:** A business must be economically viable. However, there are other benefits that women may want from the business, such as working with other women or making a needed food item available in the community.

## Preparation for the Session:

### Materials:

Participants' ideas of "benefits" from Step One  
"Things to Consider in Identifying Business Ideas" (p. 46)

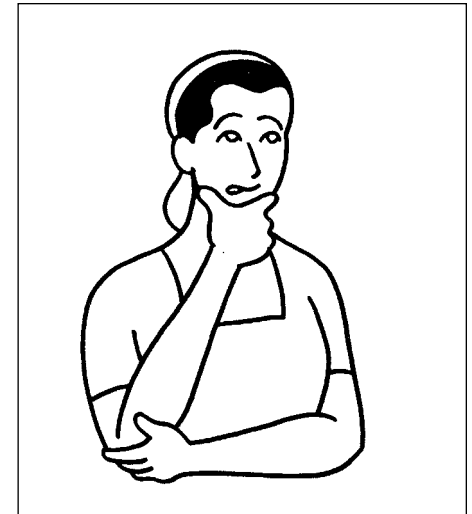

## Steps:

1. Ask the women to remember the things that were important to them when they were choosing a business idea in Step One. Add points if they do not remember them.
2. Divide the participants into three groups. Ask each group to discuss for about 10 minutes:  
Can I gain what I hoped for in this business, for myself, my family, my community?
3. Have a member of each group summarize the discussion. If the business does not meet their expectations, ask them if there are ways the business operation can be changed.
4. Continue on to the next activity, without a break.

# Is the Business a Good Idea?

**Purpose:** To enable the women to decide if they actually want to pursue the business they have been studying.

NOTE: For existing businesses, use this activity to decide whether participants think the business is worth continuing, how it can be improved, or whether they should consider other business options.

**Time:** 30 minutes

**Rationale:** This activity gives the participants a chance to think about the profits and other benefits of the planned business and to choose: “yes” or “no.”

## Preparation for the Session:

### Materials:

- Charts from previous Step Six activities
- Large paper to cover part of the wall, floor, or ground
- Crayons or pencil



## Steps:

1. Remind the women that they have examined the economic benefits and the social benefits of the business idea on which they have been working throughout the six steps. Review these benefits with them. Although some of the information has required guessing, they should decide whether or not they think it is a business idea worth pursuing.
2. Ask them to raise their hands and vote:
  - Yes, I think it is a good idea
  - No, I do not think it is a good idea.
3. Have the women discuss “why” or “why not” they voted for the idea.
4. Discuss until the group reaches consensus on whether or not they are in favor of the business idea.

NOTE: In the actual feasibility study, they may choose to study this business idea or another. So, at this point, they are not committing themselves to really start a particular business. However, based on the information they have, they should decide whether they are in favor or not in favor of the business idea.
5. Since this is the last activity, tell the women that you would like them to express how they feel about the training program and to have some fun while doing it. Ask each one to draw a picture on the same large piece of paper to depict how she feels. The group will make a “mural” together.
6. When they have finished, have the women walk around and view each other’s work. Then have each woman explain her picture.
7. Set a time and place to meet to begin the actual feasibility study.

# Part Two: Doing A Feasibility Study

Participants have learned about a feasibility study and how to do one. Now they will put their knowledge and skills into action. They will carry out their own feasibility study.

This section includes activities and guidelines for planning the study, gathering information, and analyzing the information. At the end of the study, the women will be able to decide: should we go ahead with this business?



# Tips for the Facilitator

During the study, the group will make many visits and ask many questions. This section gives the facilitator ideas about how to keep up group spirit and avoid problems while the women gather and report their information.

There are “tips” for logistics, holding meetings, and recording information. Support and encouragement from the facilitator are essential for a successful feasibility study.



# Helping Them Help Themselves

Your role during the feasibility study is very active. You must be a manager, an organizer, a resource person, an investigator, and a problem-solver.

The study can take from three weeks to two months, depending on how much time the women have. In Honduras, two groups of women in rural communities did their study in only three weeks, but they worked two or three afternoons every week. In Peru, a group of women worked on the study only once a week and took much longer to complete their feasibility study.

Mobility is the most important thing in a good feasibility study. Each person must be willing to go to other communities to visit similar businesses or to talk with suppliers of materials they may need. Finding transportation is essential.

The groups in Honduras and Peru chose to have all members of the group make each visit together. Another way to work is for the group to divide up and collect different kinds of information. You will need to help the group decide how it wants to work. Transportation can be more difficult if everyone participates in every visit. But, this builds solidarity and enables everyone to learn about all the aspects of a business.

Your work is to help set up appointments for the women, arrange for their transportation, and help them with ideas of whom to talk to and where to get their information. In some cases, you may need to find an expert in a specific area to help the group determine where to look for information and which questions to ask.

As the study progresses, you will see how well the women cooperate and how well they will be able to work together in a business. Some women may be unhappy and wish to stop participating in the work. Your job is to help the women through the difficult times and to help them work out their own problems. The more things they are able to do for themselves, the more they will learn about running a good business.

There is a Chinese proverb that tells about this idea:

Give a person a fish  
And he or she will eat for a day.  
Teach a person to fish  
And he or she will eat for a lifetime.

This is your work: helping the women to help themselves.



## Notes:

# Setting the Schedule

Before you begin the study you will make a plan and a schedule with your group (see “Getting the Information We Need”). It’s important to include:

- Things we will need to find out
- Where we will go to find out
- Whom we will talk to
- What questions we will ask
- When we will do it
- Who will do it

While you may want to work on information step by step, sometimes it may not be possible. The people you need to speak with may not be available exactly when you want to meet with them. Sometimes several sources for different kinds of information may be in the same community. It will be easier to make one trip there and to get different types of information at the same time.

You will constantly need to assess:

- What information do we have?
- What other information do we need?
- Whom else should we talk to?

Expect to revise your schedule and plan from time to time.



# Holding Meetings During the Study

During the study, weekly meetings will help keep up your group spirit and momentum. Also, it's useful to have brief meetings before and after each visit for gathering information, if these visits are scheduled at a different time than the weekly meetings. The women themselves should decide when and how often to meet. But, encourage them to meet often enough so they do not lose interest in the study.

At the group meetings, you will need to review the schedule and plan. Sometimes you will need to make changes. For example, the group may meet with someone who suggests a visit with someone you hadn't planned to meet.

The brief meetings before visits will help the women prepare to get the most out of these visits. At this time, you should talk about: "Why are we making these visits today?"

"Who are we visiting?"

"What questions should we ask?"

"What was our experience at the last visit? What should we remember to do, or not to do, at this meeting?"

The women should meet again, when possible, at the end of each day's activity. At this time, group members can tell what information they have discovered. They can also talk about any problems or suggestions to improve future work on the study. The women may have ideas on how to help each other solve the problems. They may have other concerns to bring up. Before the meeting ends, it's important to record all the information the group found out that day.

## Making the Meetings Interesting

If you meet often, the women may become a little bored if each meeting proceeds in the same way. Try to think of ways to vary the reporting of the information.

For example, the women might act out in a small play what happened during the day—repeating the questions they asked and the answers they received. This might bring some laughter and fun to the work. And it is important to enjoy the work.

Be sure to ask the women every few meetings:

"How are you feeling about the work?"

"Do you have any special worries or concerns?"

"What are you enjoying most? Why?"

"What are you learning?"

"What would you like to change?"



## If the Women Miss a Meeting...

Occasionally some people will not be able to come to a meeting. Emphasize to the women that the meetings are *very important*. Talk with the other women about what to do about it.

When the group first met, members may have set up rules to handle this situation. You may need to remind them of these rules now.

## Recording the Information

The women will collect a large amount of information during the study. It is important to have a system to record this information so that it is easy to find and use.

Here is a system that has worked well for other groups. After each visit to get information, write down what has been learned. The sample form on p. 117 can be used, or you might want to create your own. The collection of forms—one for each person or place visited—will provide a “diary” of the study.

If there are women in the group who can write, ask for volunteers to record the information. Keep the information in a safe place, because you will need it in the next section of this manual.



**SAMPLE FORM**

# Feasibility Study Information Form

NOTE: Use one form for each visit.

We visited (place): \_\_\_\_\_ Date: \_\_\_\_\_

We met with (name and title):  
\_\_\_\_\_  
\_\_\_\_\_

We found out:

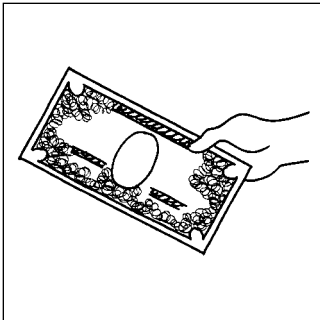

These people will buy our product or service:

\_\_\_\_\_  
\_\_\_\_\_  
\_\_\_\_\_

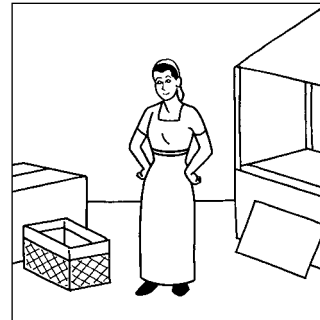

How the business will operate:

\_\_\_\_\_  
\_\_\_\_\_  
\_\_\_\_\_

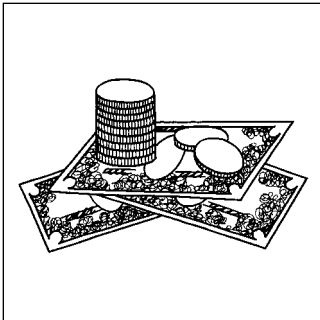

Business expenses will include:

\_\_\_\_\_  
\_\_\_\_\_  
\_\_\_\_\_

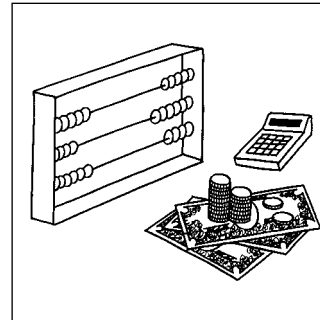

Sales income may be:

\_\_\_\_\_  
\_\_\_\_\_  
\_\_\_\_\_

Attach any cost estimates or other written information to the form.

\_\_\_\_\_  
Name of person recording the information



# Getting the Information We Need

The following four activities can be used in a 3-4 hour meeting to enable a group to plan its feasibility study. Before the planning meeting, review the “Tips for the Facilitator.” That way you will be prepared to help participants decide what they need to find out, how, and when.



**Notes:**

# Selecting a Business to Study

**Purpose:** To complete the first step for doing a feasibility study: "Choose a Product or Service to Sell."

**Time:** 30 minutes.

**Rationale:** In the actual feasibility study, the participants follow the same six steps as in the training. This activity enables them to reassess the business options they previously identified and to select one that they would like to pursue.

## Preparation for the Session:

**Materials:**

Six Steps Chart (see p. 30)

## Steps:

1. Tell the women that this is an important day. They have completed many activities in learning how to conduct a feasibility study. It is time to begin on the real one.
2. Present the "Steps" chart and ask group members to explain each step, one by one.
3. Now, the group is ready to start with "Step One: Choose a Product or Service to Sell."
4. Review the entire list of ideas which they developed in the final activity of Step One (see pp. 49-50). While they may be enthusiastic about the idea they worked on while learning the steps, they should reexamine all the old ideas just to make sure they have the best choice.
5. Ask them to vote by raising their hands for the one business idea they want to study.  
NOTE: If you have more than one facilitator and a group of at least 16, they might decide to choose two ideas to study.
6. If there is a tie vote, or strong differences of opinion, discuss the "pros" and "cons" of the idea, until the group reaches agreement.

# Why Planning is Important

**Purpose:** To define the important elements of a plan.

**Time:** 30 minutes.

**Rationale:** Doing a feasibility study involves thinking ahead, about what information to collect and about how a business will perform in a one to three year period. This activity lays the foundation for the “forward thinking” by identifying why planning is important and what it involves.

## Preparation for the Session:

### Materials:

Six Steps Chart

## Steps:

1. Show the “Steps” chart again. Remind the group that they already have completed Step One. It is now time to plan how to carry out the other steps. But first, it is important to talk about how to make a plan.
2. Tell the women that:  
Making a plan is very important before beginning a project. In making a plan, you do several things:
  - List your resources
  - Decide what needs to be done and in which order
  - Decide who will do it and by when.
3. Help the women to understand planning by using a personal example, such as making tea or coffee. Ask the group:  
“What resources do you need?”  
“What tasks (or steps) have to be done to make the tea or coffee?”  
“What steps need to be done first, second, etc.?”  
“Who will do what and when?”
4. Ask the women to give other examples of planning in their lives, such as community or family celebrations, trips, and so on.
5. Conclude the activity by asking:  
“Why is planning important? What happens if we don’t plan well?”

# Planning Our Feasibility Study

**Purpose:** Prepare a plan for doing a feasibility study.

**Time:** 2 hours.

**Rationale:** This activity enables the participants to decide what information they need for their feasibility study and how to get it.

## Preparation for the Session:

### Materials:

Six Steps Chart (see p. 30)

8 "Business Cost" posters (see pp. 67-82)

2 "Sales Income" posters (see pp. 97 and 99)

A large calendar

## Steps:

1. Put up the Six Steps Chart and the 10 posters. Tell the participants that these posters will help them remember the information they need to find out for their study.
2. Divide the women into four groups and assign one group each step:
  - Group 1** Step two: Find out if people will buy our product or service
  - Group 2** Step three: Determine how the business will operate
  - Group 3** Step four: Calculate business expenses
  - Group 4** Step five: Estimate sales income.
3. Ask each group to discuss:
  - "What do we need to find out for our step?"
  - "How can we find out this information?"
4. Visit each group as they are working to give them help if needed. Allow about 20 minutes for discussion. Have each group choose someone to present its ideas.
5. When the small group discussion seems to have ended, have the groups present their reports one by one. After each presentation, ask for other ideas on what the participants need to find out and how.

6. After the presentations, show the group the calendar. Explain that you would now like them to decide what visits they will make and when. Emphasize that they may be able to find out information for more than one step in one visit. Ask them:
  - “What information would you like to find out first?”
  - “Where will you go?”
  - “When?”
  - “Who will participate?”
7. Write the first visit on the appropriate date on the calendar. Note: For groups with literacy skills, you can write a schedule for several visits over the next few weeks.
8. Also, decide how often your group will meet to discuss the information they find and to keep up a sense of unity during the feasibility study.
9. At the end of the activity, be sure everyone is clear on the date and time for the first visit.



# Gathering Information From “Experts”

**Purpose:** To practice interviewing experts and officials to gather information for the feasibility study.

**Time:** 1-2 hours.

**Rationale:** In their feasibility study, the women will need to talk with “experts” and officials in their community. In some cases, they may have little experience contacting people, particularly men, at this level. This activity enables them to prepare for these meetings.

## Preparation for the Session:

### Materials:

Calendar from the previous session

## Steps:

1. Explain that the purpose of the activity is to practice for meetings with people who will provide information for their study.
2. Divide the group into teams of three or four. Ask each group to think about one of the visits they have planned to get information from an “expert” or official. They should decide who they will visit and what information they need to find out. Suggest that the group think about:
  - “What is the purpose of your visit?”
  - “Who are you going to meet with?”
  - “What do you want to find out?”
  - “What questions will you ask? How will you behave?”
3. Ask each group to plan and present a short play on their meeting. Give the group at least 20 minutes to plan their plays. Visit each group to assist as needed.
4. Have the groups present their plays one by one. After each presentation, ask the group:
  - “What was effective about the meeting?”
  - “Can you add any other questions?”
  - “What ideas do you have for your own visits?”



# Deciding on Our Business

The activities in this section enable the participants to organize and analyze the information they have gathered, so they can make their big decision: should we pursue this business?

This final step takes about seven hours and can be divided into two meetings.



**Notes:**

## To the Facilitator

The group, with your assistance, is now ready to perform some basic financial analyses, using the information they have collected. It is important to have all the completed “information forms” on hand and to read the activity guidelines before the meeting. Some of the activities look complicated; but if you take them step by step, they are not so difficult.

Do not worry if you feel you are “not good at math.” A small hand-held calculator will be very helpful to you and to the group as well.

Not all the group members will fully understand each part of the financial analysis. This is all right, as long as some of the women do. These individuals may take on positions in the business that deal with money, such as “administrator” or “treasurer.”

Don’t let the fancy names of the activities fool you. Remember that a short time ago the words “feasibility study” sounded threatening. Look how far the group has come in that short time.

There are some important points to stress during this final analysis of the feasibility study materials.

### **REMEMBER**

- Businesses don’t generally make a profit during the first year.
- You will have to work very hard before there are monetary benefits.
- Satisfaction and frustration will be commonly felt; it seems they go hand in hand.
- Starting a business is a real growth experience and you must not lose faith.

# BUSINESS PLAN

\_\_\_\_\_  
(Groups Name and Number of Members)

## Our Business

Our proposed business is:

---

---

---

---

---

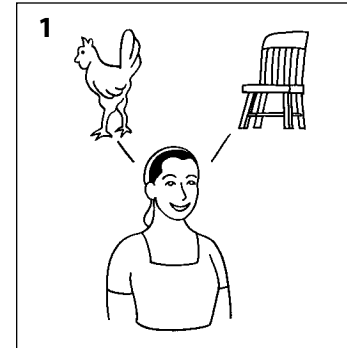

We need to learn these skills:

---

---

---

---

---

Our business location:

---

---

---

---

---

---







# Business Operation

Our production plan for one year (schedule and quantities) is:

each day \_\_\_\_\_

each week \_\_\_\_\_

each month \_\_\_\_\_

The total amount to be produced in one year is:

\_\_\_\_\_  
\_\_\_\_\_

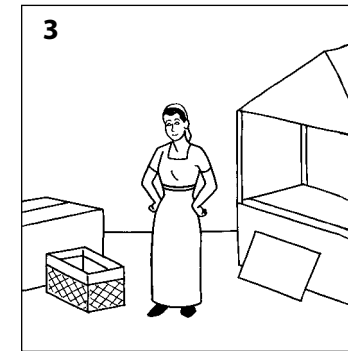

The people who will work are (who and how many):

\_\_\_\_\_  
\_\_\_\_\_  
\_\_\_\_\_  
\_\_\_\_\_

We will divide the work like this:

\_\_\_\_\_  
\_\_\_\_\_  
\_\_\_\_\_  
\_\_\_\_\_

The people responsible for managing our business are (list any positions like manager or treasurer and what they do):









\_\_\_\_\_  
\_\_\_\_\_  
\_\_\_\_\_  
\_\_\_\_\_  
\_\_\_\_\_

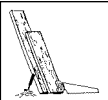



# Business Expenses

Our start-up expenses will be:

- \_\_\_\_\_ 
- \_\_\_\_\_ 
- \_\_\_\_\_ 
- \_\_\_\_\_ 
- \_\_\_\_\_ 
- \_\_\_\_\_ 
- \_\_\_\_\_ 
- \_\_\_\_\_ 

TOTAL \_\_\_\_\_

Our operating expenses for one year will be:

- \_\_\_\_\_
- \_\_\_\_\_
- \_\_\_\_\_
- \_\_\_\_\_
- \_\_\_\_\_
- \_\_\_\_\_
- \_\_\_\_\_
- \_\_\_\_\_

TOTAL \_\_\_\_\_

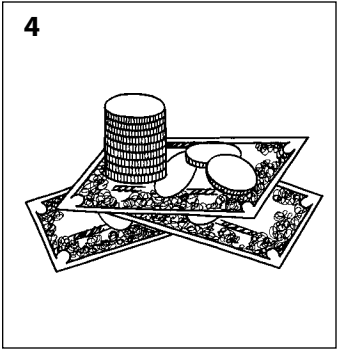

We can borrow money from:  
 \_\_\_\_\_  
 \_\_\_\_\_

Our interest rate will be:  
 \_\_\_\_\_

Our monthly payments will be:  
 \_\_\_\_\_

and will start in:  
 \_\_\_\_\_



# Sales Income

Our price of our item/service is: \_\_\_\_\_

We estimate we can sell this quantity:

each day \_\_\_\_\_

each month \_\_\_\_\_

each year \_\_\_\_\_

Our competitor's price per item/service is:

They sell: each day \_\_\_\_\_

each month \_\_\_\_\_

each year \_\_\_\_\_

We estimate our sales income for one year to be: \_\_\_\_\_

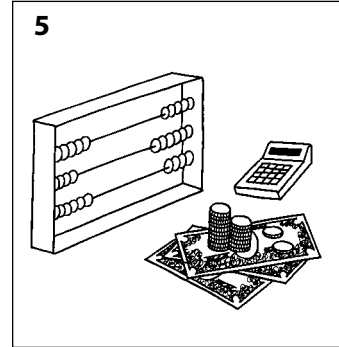

# Business Benefits

Our business has these benefits:

---

---

---

---

---

---

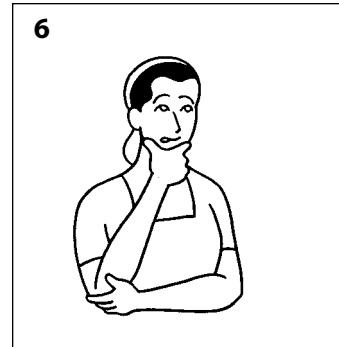

Our business has these risks:

---

---

---

---

---

---



# Making Our Business Plan

**Purpose:** To organize all the information about the proposed business on one form.

**Time:** 2-3 hours.

**Rationale:** The group has gathered a lot of information about the proposed business. The “Business Plan” provides a way to compile all this data, in a way that describes their business and its operation.

## Preparation for the Session:

### Materials:

Forms on the previous pages, copied on large paper and posted  
Information forms completed during the “research” for the feasibility study

NOTE: This activity requires some reading and writing skills. If no one in the group can read and write, the facilitator needs to serve as recorder.

## Steps:

1. Tell the group that they will now make their “business plan.” This means they will describe their business, including expected costs and sales.
2. Using the chart, go through the items one by one. Refer to the completed information forms as needed.
3. The group may still have differences of opinion about aspects of the business. Completing the form will help them clarify what they plan to do. End the activity when the form is completed.
4. Take a break.



# Determining Cash Needs to Start the Business

**Purpose:** To determine more exactly how much money the women will need to start their business.

**Time:** 1 hour.

**Rationale:** “The Business Plan” gave an overview of the entire business. This activity identifies the capital needed to begin.

## Preparation for the Session:

### Materials:

One of the three investment plan forms (see pp. 141-142)  
Product/Service  
Agriculture  
Animal raising

## Steps:

1. Tell the participants that it is essential to determine how much money they need to start their business.
2. Choose the form that is appropriate for your group’s business.
3. Explain that an investment plan is a one year budget for the business. This includes “startup” expenses plus one year of “operating” expenses.

NOTE: Do not include any loan payments in the first year “operating” expenses for the investment plan.

4. Using the information on the business plan, write in the amounts for each item. You may need to refer back to some of the Information Forms for specific numbers. Depending on the numeracy skills in your group, you may need to provide a lot of support and encouragement during this activity.
5. When the form is completed, ask the group if members have any questions about what they have been doing. Discuss any areas that need clarification.

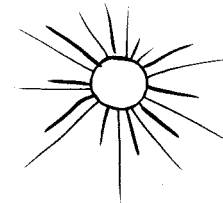

6. Now, help the group determine how much money they need to borrow. Explain that the group needs cash to cover the “start-up” expenses and part of the “operating” expenses that will not be covered by income (in some cases, a full year of operating expenses must be included, in others, this amount can be less; see the example “Making Jelly in Costa Rica” on p. 144 ).

7. Ask the group:

“How much cash do you need to start the business?”

“How much cash do you need for operating expenses?”

“How much cash, if any, do you have on hand?”

“How much do you need to borrow?”

“Where can you get a loan? at what interest rate?”

NOTE: The women may not be able to calculate the portion of operating expenses they need to borrow until they complete the “cash flow analysis” in the next activity. If so, return to these questions about the amount of loan needed after that activity.

## Investment Plan: Product/Service

ITEM	WHAT WE NEED	WHAT WE HAVE	COST
Equipment	_____	_____	_____
Raw Materials	_____	_____	_____
Transportation	_____	_____	_____
Construction	_____	_____	_____
Labor	_____	_____	_____
Training	_____	_____	_____
Packaging	_____	_____	_____
Promotion	_____	_____	_____
Other	_____	_____	_____
		TOTAL:	_____

# Investment Plan: Agriculture

ITEM	WHAT WE NEED	WHAT WE HAVE	COST
Land	_____	_____	_____
Equipment	_____	_____	_____
Seeds	_____	_____	_____
Inputs (such as fertilizer)	_____	_____	_____
Transportation	_____	_____	_____
Labor	_____	_____	_____
Packaging	_____	_____	_____
Promotion	_____	_____	_____
Other	_____	_____	_____
		TOTAL:	_____

# Investment Plan: Animal Raising

ITEM	WHAT WE NEED	WHAT WE HAVE	COST
Animals	_____	_____	_____
Materials	_____	_____	_____
Food	_____	_____	_____
Medicine	_____	_____	_____
Construction	_____	_____	_____
Labor	_____	_____	_____
Transportation	_____	_____	_____
Training	_____	_____	_____
Packaging	_____	_____	_____
Promotion	_____	_____	_____
Other	_____	_____	_____
		TOTAL:	_____



# Determining Cash Needs to Operate the Business

**Purpose:** To determine when money will be needed in the business and if it will be available when it is needed.

**Time:** 2-3 hours.

**Rationale:** A business can end a year with a profit, but have several months during that year where it is operating at a loss. This activity enables women to anticipate the monthly “income and expenses” situation of their business. This is called analyzing your cash flow or cash flow analysis.

## Preparation for the Session:

### Materials:

Business and Investment Plans  
“Cash Flow” Chart for three years, copied on large paper and posted (see sample on pp. 146-147)  
“Notes on Cash Flow Analysis” (pp. 143-147)

1. This activity will probably be the most difficult of any for your participants. Be well prepared, so that you can help them through it, since it is a vital calculation for their business. The “Notes on Cash Flow Analysis” on pp.145-149 provide an actual example of a business and its monthly and yearly projections. This is background information for you, and is not designed to be used with your participants. However, if the group is literate, it may be a useful example for them to consider.

## Steps:

1. Remind the women of the story of Rosa and Pablo, the couple who wanted to buy a bed. Ask: “Why is it important to know when we will make a profit?”
2. Explain that they will project their monthly income and expenses for a three year period.
3. Use the “cash flow chart” and enter the expenses from the Business Plan for each month.

**Notes:**

4. Enter the estimated sales income.
5. Subtract expenses from income each month to determine each month's profit or loss and available cash.
6. Calculate the accumulated profit from month to month.
7. Calculate the yearly totals for income, expenses, and profit or loss.
8. Ask the women:
  - "Is the business profitable?"
  - "Are there some months when you will have a loss?"
  - "How can this be avoided?" (for example, by delaying expenses or having a longer period for loan repayment)
  - "If it cannot be avoided, how will you cover your expenses for that month?"

**SPECIAL NOTE:**

There is no magical formula for determining a reasonable profit margin or rate of return for the level of small business your participants are probably considering. However, one standard is to compare the profits to the amount the women invested and the value of their time worked (i.e. the equivalent amount they would have made in a local salaried position for someone with their skills). This can help them assess whether the business is worth the investment of their money and time.

### Yearly Cash Flow Chart

MONTH	1st	2nd	3rd	4th	5th	6th	7th	8th	9th	10th	11th	12th	TOTALS
SALES INCOME													
EXPENSES													
PROFIT OR LOSS EACH MONTH													
ACCUMULATED PROFIT OR LOSS													

# Notes on Cash Flow Analysis

Depending on the business chosen by the women, the cash flow analysis could be very complicated for the women to understand. Make it as simple as possible for them, but someone in the business (or a business advisor) must understand and work out the cash flow before the business begins. And, obviously, someone will have to monitor the cash flow month by month during the year.

A cash flow analysis means studying the money that will come into a business and the money that must be paid out over certain periods of time. Usually, the money coming in and going out is not the same amount every month. One month there may be more than enough income to pay the bills and another month the bills may exceed income. Doing a cash flow analysis helps plan, month by month.

To help you understand some of the possible complications in setting up a new business and doing a cash flow chart, here is a story of a small business started in Costa Rica. This example is provided to give you, the facilitator, more background on cash flow analysis. However, if you think it useful, it can also be used with the group as another example like the “Rosa and Pablo” story (pp. 103-104).



## Making Jelly in Costa Rica

In a rural area outside of San Jose, the capital of Costa Rica, a group of four women are starting a business making jelly. They plan to make mango, guava and orange jellies and sell them to stores in San Jose. They will be using the family recipe of one of the women which is very simple and does not use any artificial colors or preservatives. While all of the women have had experience making jelly, they have never worked collectively. One woman has a large enough kitchen so that the four can work there and cook two large batches of jelly in one day. However, they need to purchase a machine that will help them cut the fruit into pieces. Cutting the fruit by hand was fine when they only made small amounts for their families, but they need to prepare much more to make two large batches of jelly. To buy this machine, they need \$100. They also need to buy two very large pots and ladles, which will cost \$20.

The women have free access to some oranges, mangoes and guava that grow near their homes. However, for the large quantities of jelly they are planning to sell, they know they will also buy some fruit from local producers. Because of the local growing seasons, they will be able to make mango jelly in May, June and July; guava jelly in September and October; and orange jelly in December, January and February. This means that in March, April, August and November, they will not be able to produce any jellies. They will have to plan their business very carefully and calculate their costs to make sure that their small business can survive these months when they will have no sales.

Once the women have bought the machine, pots and ladles, they will be ready to buy the ingredients for the jelly and the jars to put it in. These jars and ingredients are the major costs of the business. The women plan to make jelly three days a week in the months when they have fruit. Two large batches of jelly make a little over 222 jars, so the women will need to buy 2666 jars each month. These jars with lids and labels cost \$640 each month. The fruit they have to buy will cost \$496 each month. The sugar

that they use in the recipe will cost \$150 monthly. They estimate the cost of the water that they use to make the jelly to be \$3 each month.

Based on their feasibility study, the women realize that they will have transportation costs, utility costs and other costs related to keeping records and taking orders that will total \$160 each month.

The women have spoken to the owners of the stores in San Jose, and they are willing to pay \$1 for each jar of jelly. A small shop that caters to tourists might be willing to pay more, but the women are basing their sales price on what the majority of stores are able to pay. They want to sell 2666 jars each month, so they are estimating their sales at \$2666 monthly.

The women will be able to sell their product the very first month it is produced, but they will still need a loan to buy the machines, pots and ladles, as well as the ingredients for the first month. This will cost \$1569. They have investigated various banks, and think that they will have to pay 15% interest on the money they borrow. They will have to begin repayment in the third month that the business is in operation, and will make payments every month for one year. The payments will be \$150 a month ( $\$1569 + \$235 \text{ interest} = \$1804 \text{ total divided by } 12 \text{ months} = \$150$ ).

In order to keep the costs to a minimum, and to be sure that there is enough money to pay back the loan and pay bills during the months when they are unable to make jelly, they have agreed not to take salaries at first. They will volunteer their time until the business has been established for six months, then they will each take a salary of \$250 per month during those eight months when they are selling jelly. They will not take salaries during the months when no jelly is produced. The remaining profit they will leave in the business accounts, so that in case of an emergency, a need to replace equipment, or a desire to expand, they will have the money needed.

# Investment Plan

Use the appropriate investment plan (pp. 139-140 ) and fill out the budget for one year. It should look similar to this when finished.

Machine, pots and ladles	\$ 120
Jars	5120
Sugar	1200
Water	24
Fruit	3968
Misc. (transportation, utilities, etc.)	1920
Labor	3000
TOTAL	<u>\$ 15,353</u>

## Expenses

Put the expenses for each month on the expense line of the chart:

1. Start-up and first month operation: put \$1569 in Month 1.
2. Production:  
put \$1449 in each month of production (jars—\$640; fruit—\$496; sugar—\$150; water—\$3; and administration—\$160).
3. Loan repayments:  
put \$150 in Year I/July-April and Year II/May-June (\$1569 principal + \$235 interest @ 15% = \$1804 total divided by 12 months = \$150 per month).
4. Non-production months (August, November, March and April): Year I—put \$310 in each month (\$150 loan payment + \$160 administration) Year II—put \$160 administration in each month
5. Salary:  
Put \$1,000 for salaries, beginning Year I/December, *except* in the non-production months (August, November, March and April).

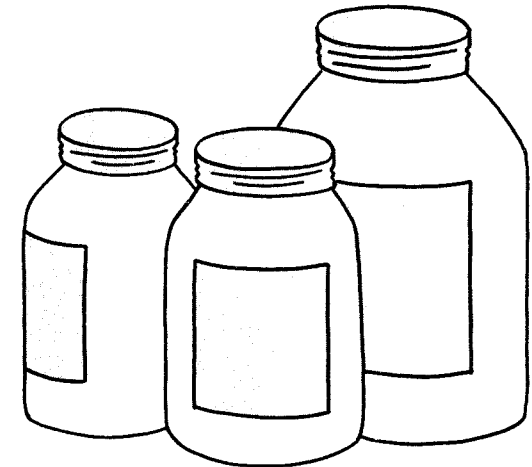

## Sales Income

Put the income for each month on the income line of the chart: \$2666 for each month, except August, November, March and April.

## Profit or Loss

Subtract each month's expenses from income to determine that month's available cash. Calculate total income, total expenses, and total profit for Year I, II, and III.

NOTE: Point out that in some months, such as August, there is a loss. However, the cumulative profit is sufficient to cover this loss. If the cumulative profit were not sufficient, the business women would have to reduce salaries for the month or make arrangements for credit with suppliers.

## Analysis

The business shows a profit each year, though minimal in Year II. The women are each paid a salary of \$2,000 a year, so they have personal income from the business even if they do not yet share in the profits. At the end of Year III, they have \$6368 in their account, and consider raising their salaries or expanding their business.

### Year I

MONTH	1st	2nd	3rd	4th	5th	6th	7th	8th	9th	10th	11th	12th	TOTALS
SALES INCOME	2666	2666	2666	-0-	2666	2666	-0-	2666	2666	2666	-0-	-0-	21,328
EXPENSES	1569	1449	1599	310	1599	1599	310	2599	2599	2599	310	310	16,852
PROFIT OR LOSS EACH MONTH	1097	1217	1067	(310)	1067	1067	(310)	67	67	67	(310)	(310)	4,476
ACCUMULATED PROFIT OR LOSS	1097	2314	3381	3071	4138	5205	4895	4962	5029	5096	4786	4,476	4,476

## Year II

MONTH	1st	2nd	3rd	4th	5th	6th	7th	8th	9th	10th	11th	12th	TOTALS
SALES INCOME	2666	2666	2666	-0-	2666	2666	-0-	2666	2666	2666	-0-	-0-	21,328
EXPENSES	2599	2599	2449	160	2449	2449	160	2449	2449	2449	160	160	20,532
PROFIT OR LOSS EACH MONTH	67	67	217	(160)	217	217	(160)	217	217	217	(160)	(160)	796
ACCUMULATED PROFIT OR LOSS	4543	4610	4827	4667	4884	5101	4941	5158	5375	5592	5432	5272	5272

## Year III

MONTH	1st	2nd	3rd	4th	5th	6th	7th	8th	9th	10th	11th	12th	TOTALS
SALES INCOME	2666	2666	2666	-0-	2666	2666	-0-	2666	2666	2666	-0-	-0-	21,328
EXPENSES	2449	2449	2449	160	2449	2449	160	2449	2449	2449	160	160	20,232
PROFIT OR LOSS EACH MONTH	217	217	217	(160)	217	217	(160)	217	217	217	(160)	(160)	1096
ACCUMULATED PROFIT OR LOSS	5489	5706	5923	5763	5980	6197	6037	6254	6471	6688	6528	6368	6368

# Should We Pursue This Business

**Purpose:** To decide whether to pursue the business activity or not.

**Time:** 1 hour.

**Rationale:** This activity gives the group a chance to consider all the data and decide: "yes" or "no."

## Preparation for the Session:

### Materials

"Decision-Making Checklist" (in box)

## Steps:

1. Tell the group that they are now ready to make the decision on whether to go ahead with their business idea or to look for another. This is the moment they have been building up to since the program began!
2. Remind the group that the previous activities gave a pretty good indication of the profitability of the business. But, they may still have some other concerns besides profits.
3. Present the "Decision-Making Checklist," either orally or on large paper. Have them say whether each factor is "positive" or "negative."
4. When all the items are completed, ask:
  - "Are most of our answers in the "positive" or "negative" column?"
  - "Is there any negative factor, such as lack of credit, that makes the business impossible?"
  - "What is our decision about the business: yes or no? Why?"
5. If a "yes" decision is made: Break into small groups and ask the women to discuss what they are looking forward to most about starting a business and what they fear the most.
 

If a "no" decision is made: Refer back to the earlier activities where the group listed a number of business possibilities and plan for a time to convene and reexamine other options.

## DECISION-MAKING CHECKLIST

### ECONOMIC FACTORS

### POSITIVE

### NEGATIVE

Will there be a profit? \_\_\_\_\_

Can we get credit? \_\_\_\_\_

Is the market steady? \_\_\_\_\_

### SOCIAL FACTORS

Do we provide a needed product/service? \_\_\_\_\_

Will this business help our community progress? \_\_\_\_\_

Will we make our own decisions? \_\_\_\_\_

Do we have sufficient time to dedicate to the business? \_\_\_\_\_

Do our families support the idea? \_\_\_\_\_

### INTUITIVE FACTORS

What are the risks? \_\_\_\_\_

What is our feeling about the business? \_\_\_\_\_



# Business Start-up: First Steps

**Purpose:** To enable the group who has made a “yes” decision to plan their next steps.

**Time:** 30 minutes.

**Rationale:** This activity builds on the momentum of the feasibility study by immediately involving the women in starting their business.

## Steps:

1. This activity is an informal discussion for the women to identify what to do next. To begin, just ask:

“You decided what business to pursue. What do you need to do now?”

2. The group may focus on credit. Help the group review sources of credit and how to apply for it. Once the credit sources are lined up, the process should not take more than a month. Also, the group may need to purchase equipment or rent a workplace.
3. Set a time and place for the next meeting. Decide who will do what before that meeting. It’s important to keep up momentum and start the next phase as soon as possible.
4. Congratulate everyone on the hard work she’s done and how much has been accomplished. Have a business launching party!

**Notes:**





# Poster Story Illustrations

The following eighteen posters are to be used with the Poster Story on pages 34 through 38, or they can be adapted for your own group, as described on page 33.





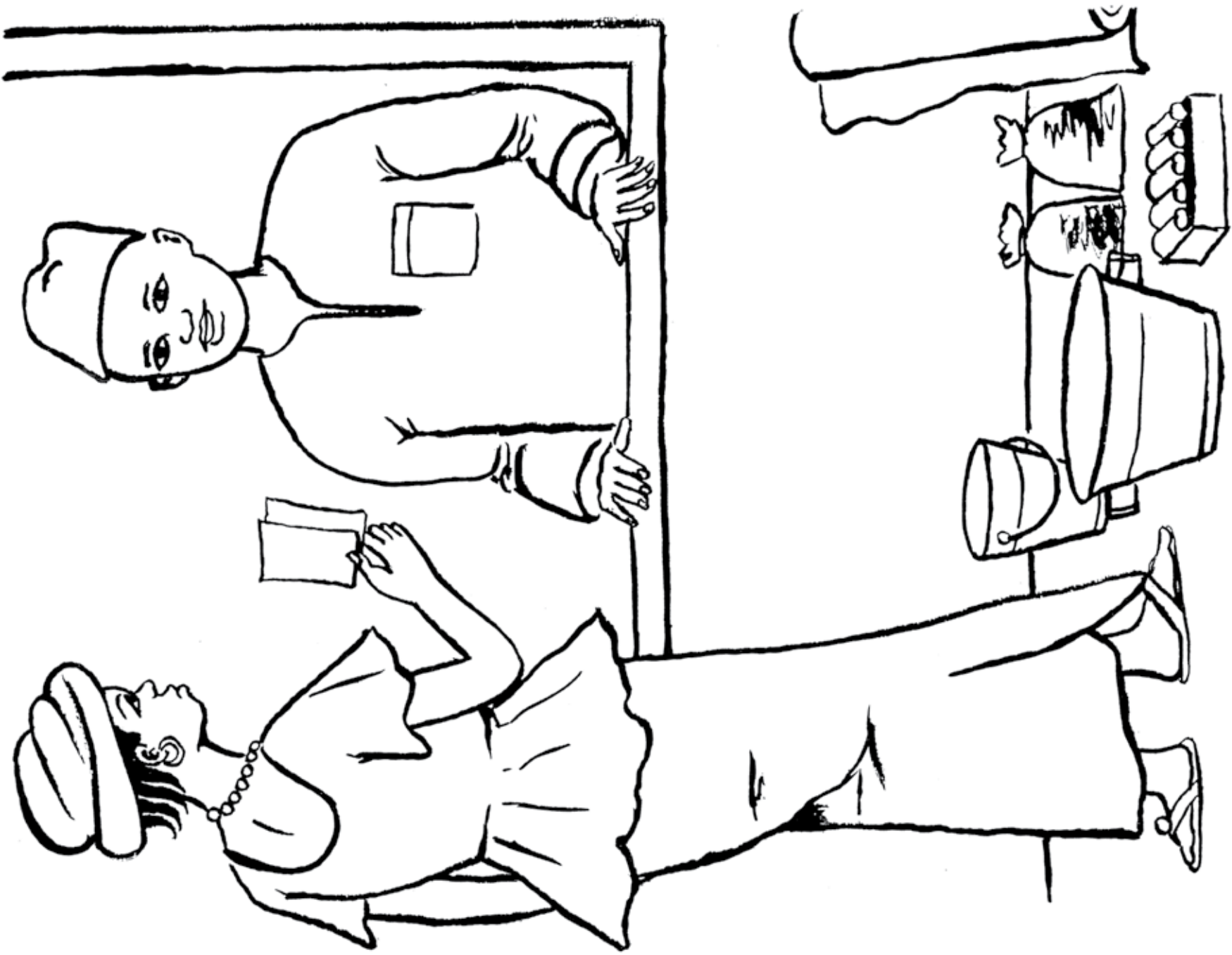

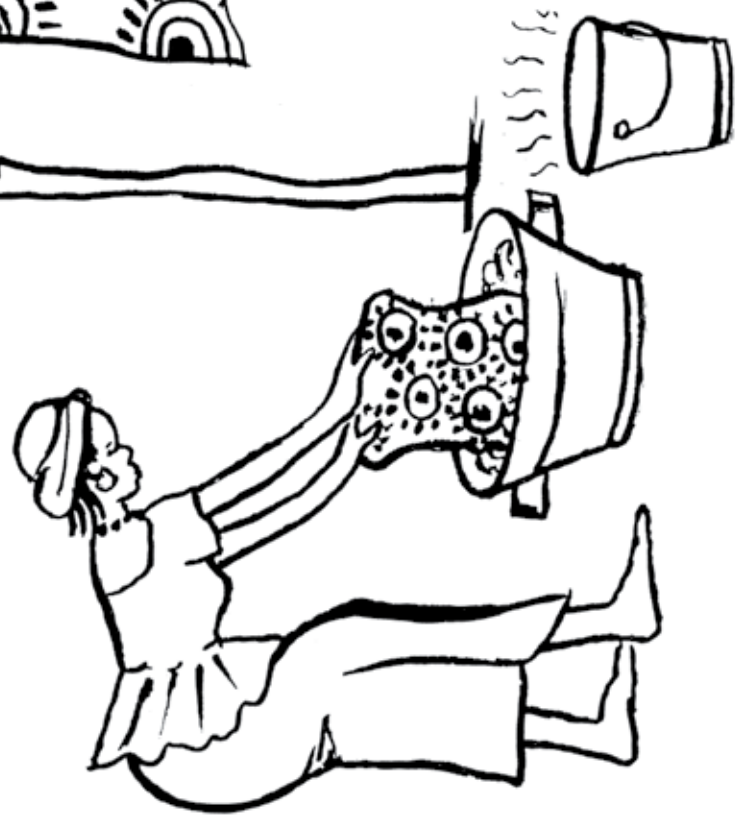
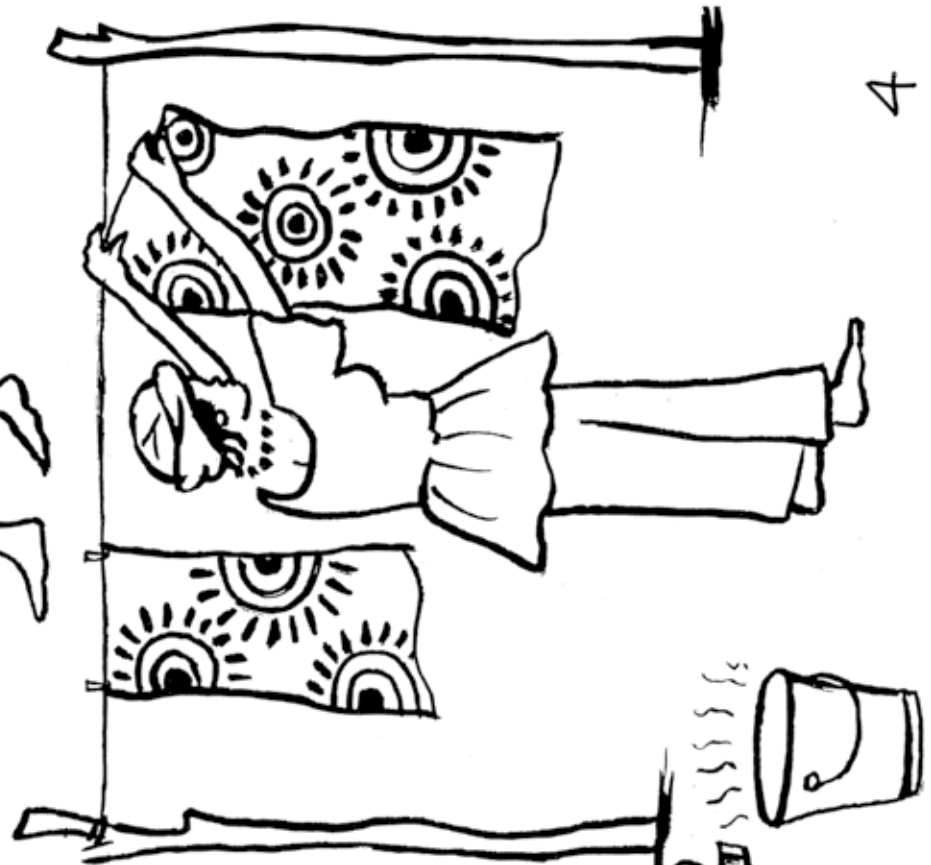
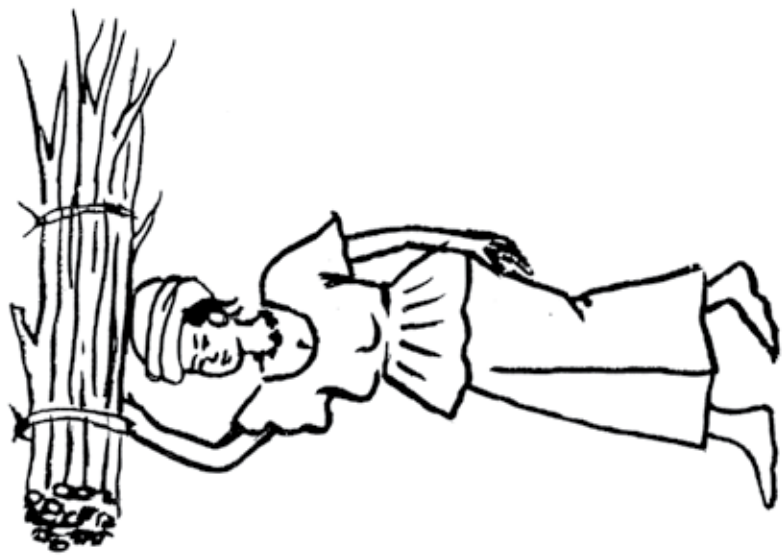





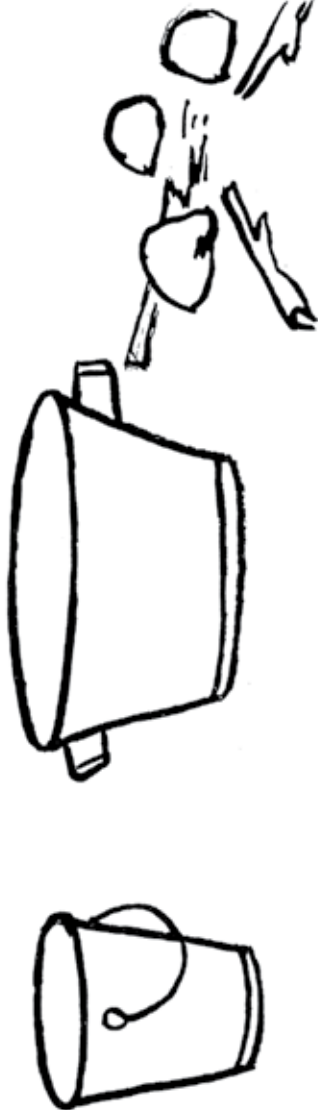
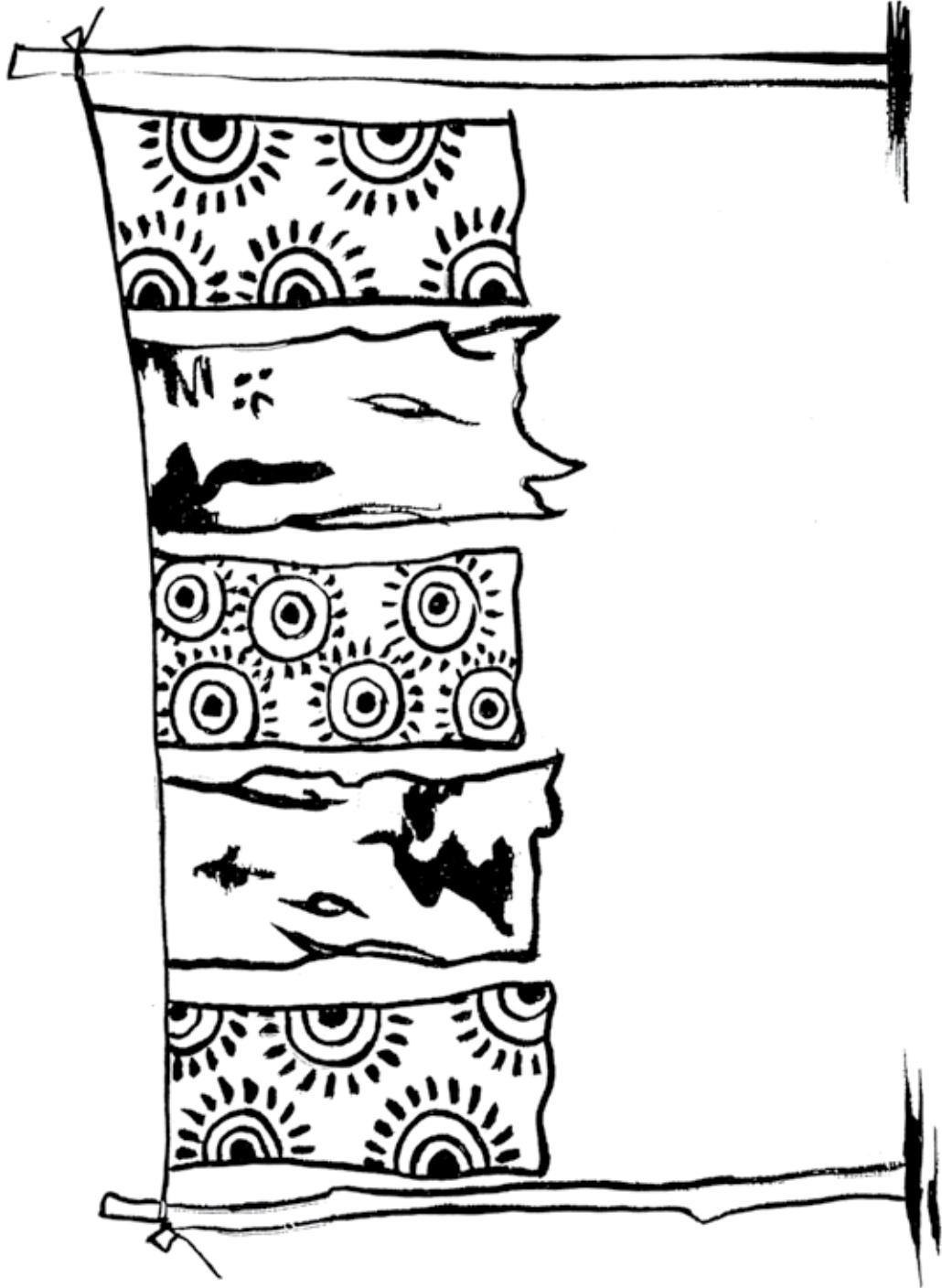

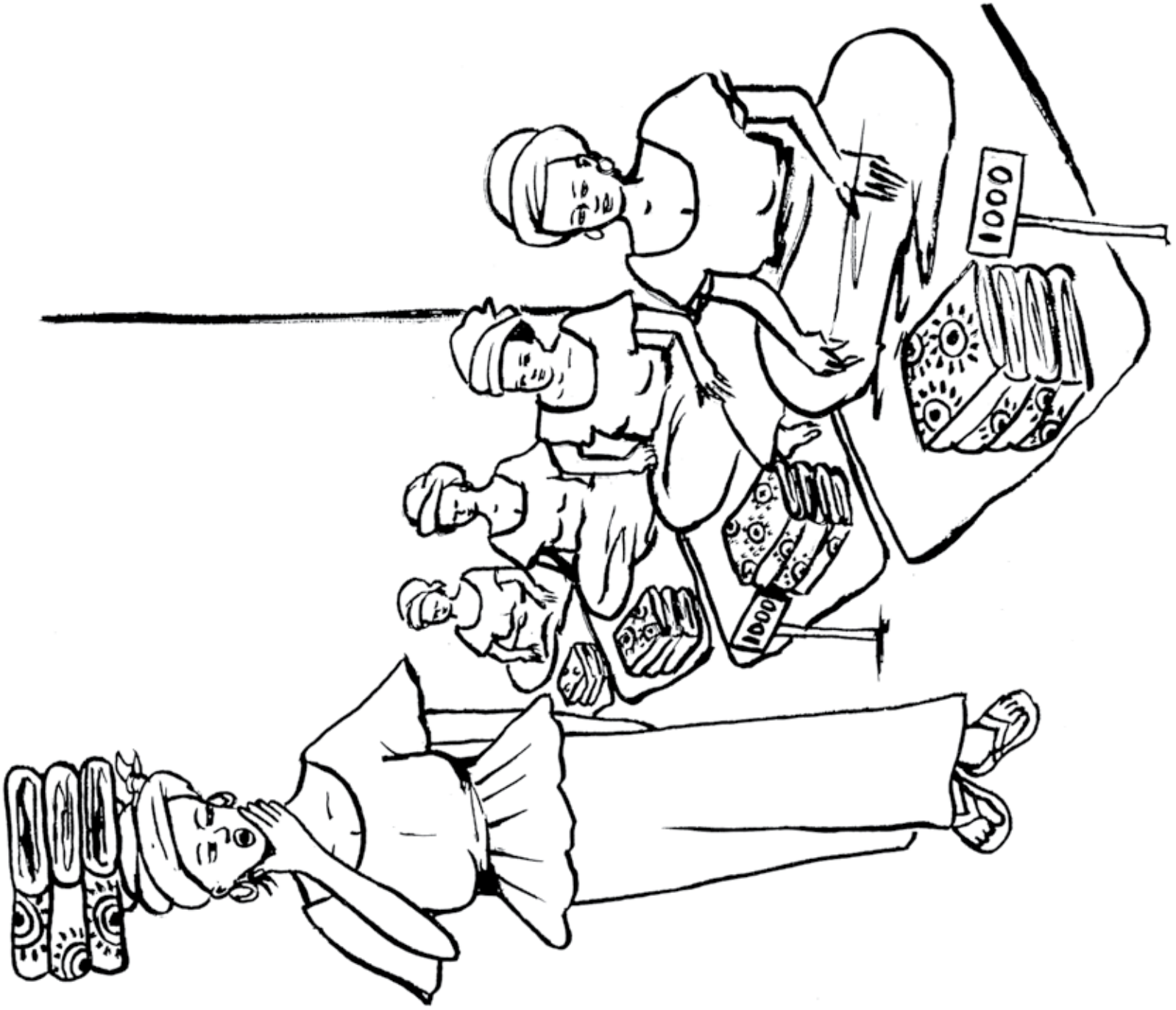

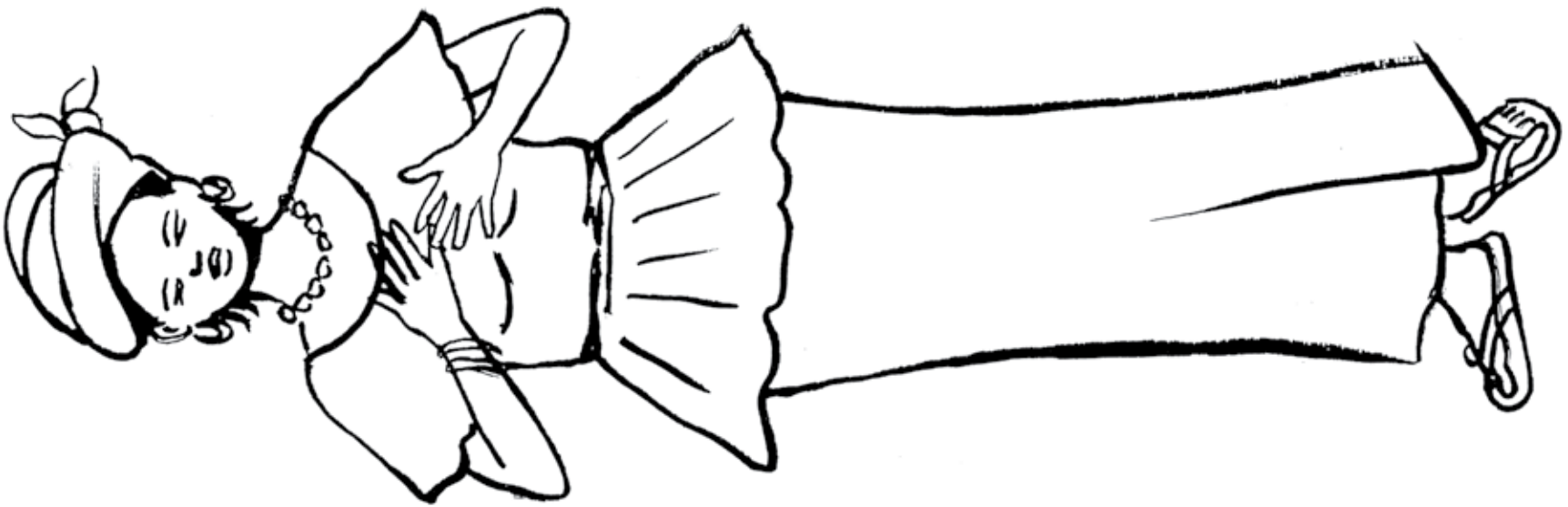

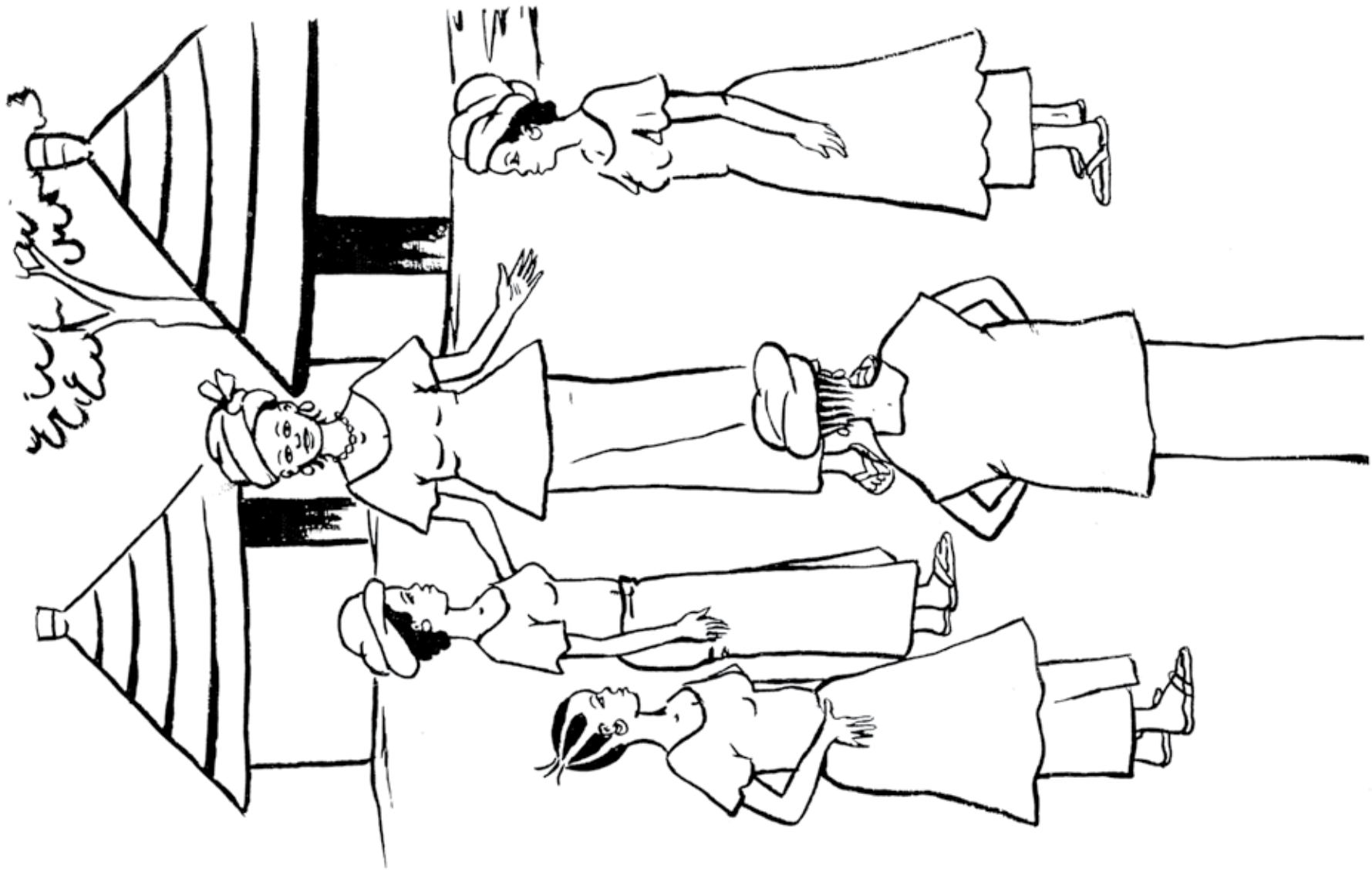

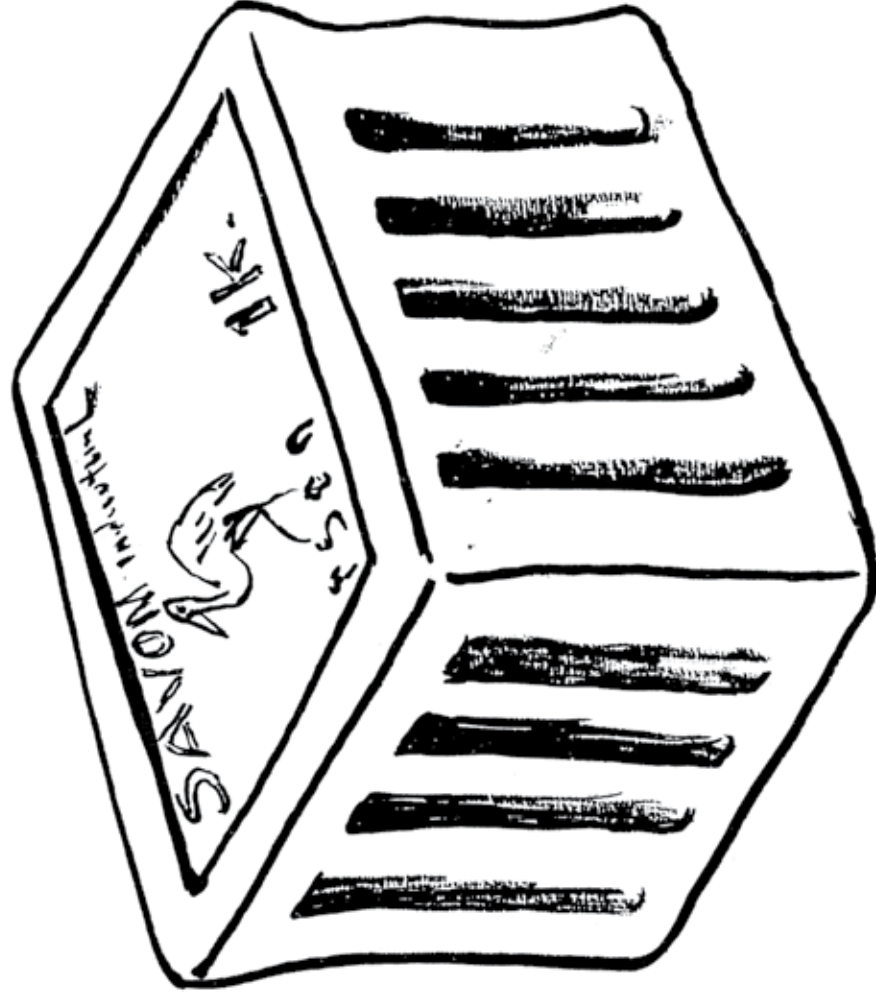

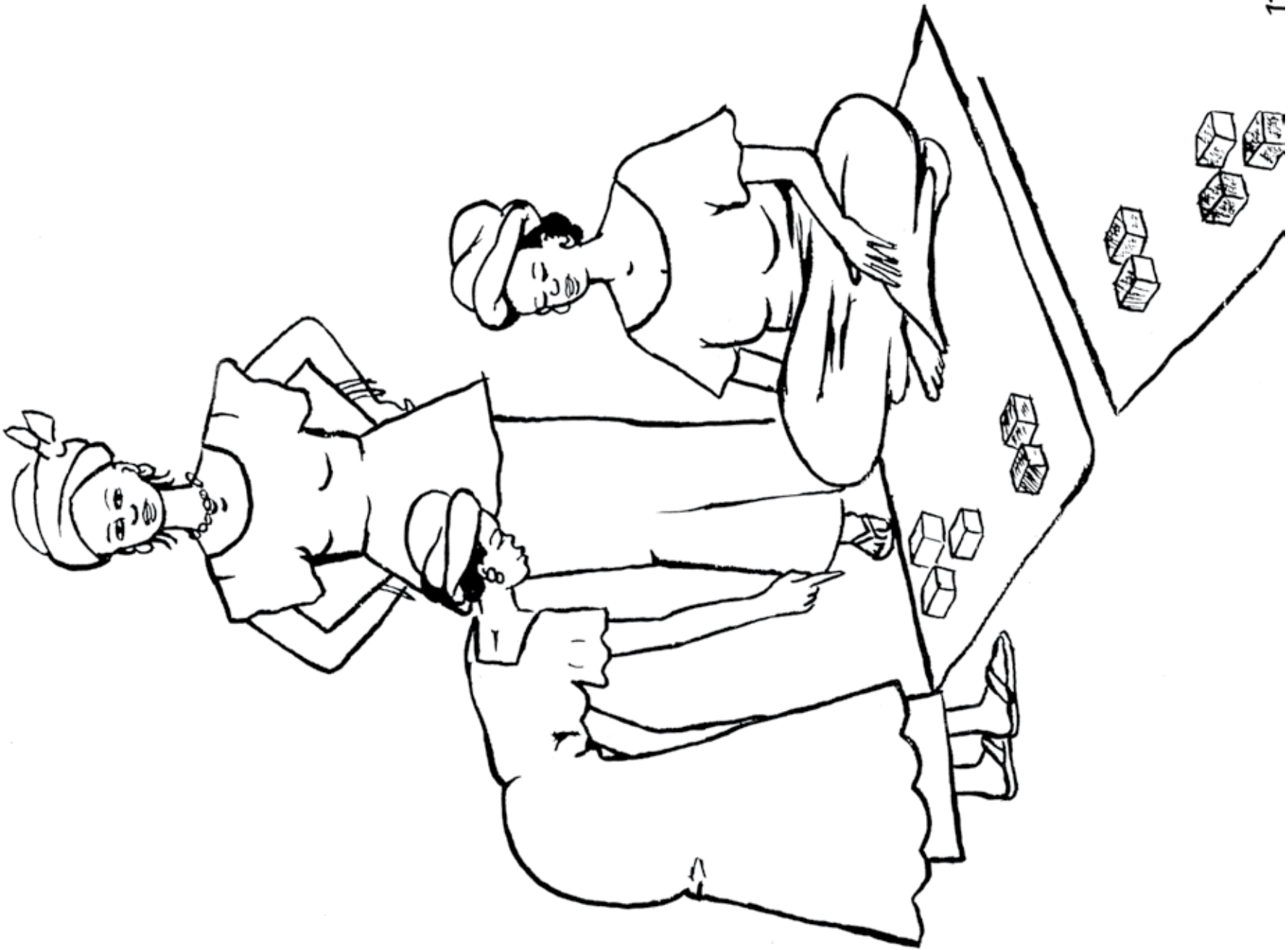

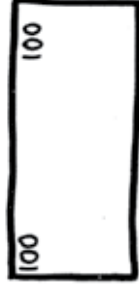
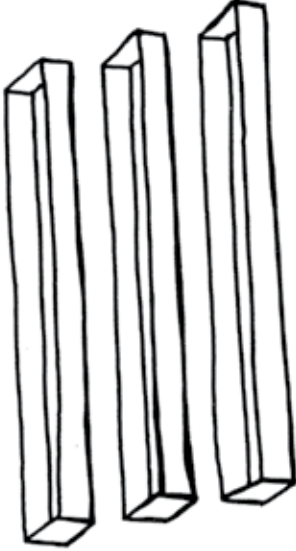
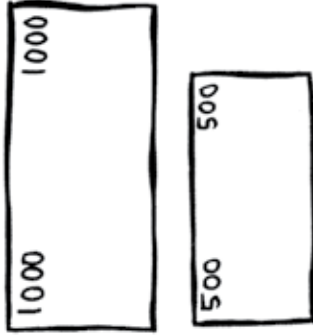
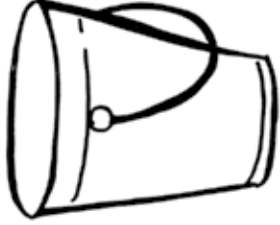
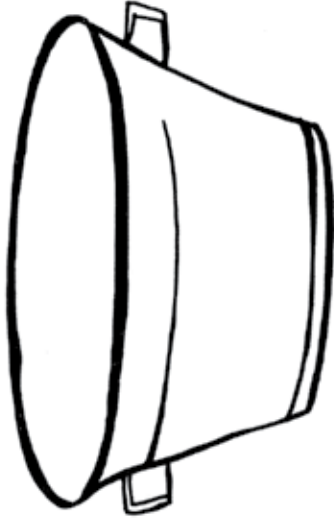
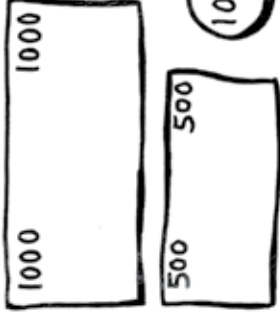
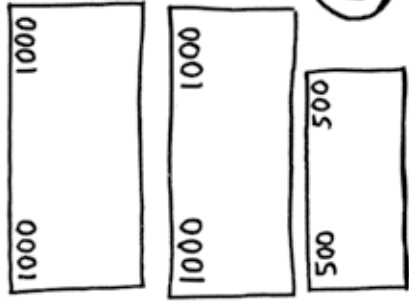

1000 1000

100 100 100 100

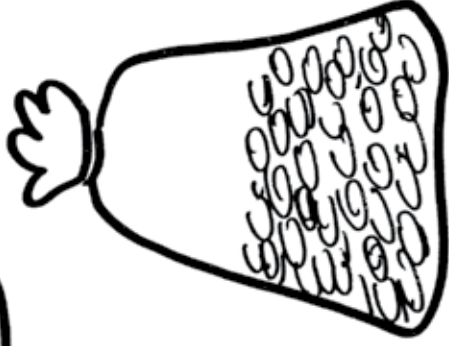
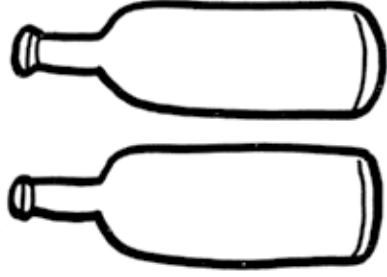
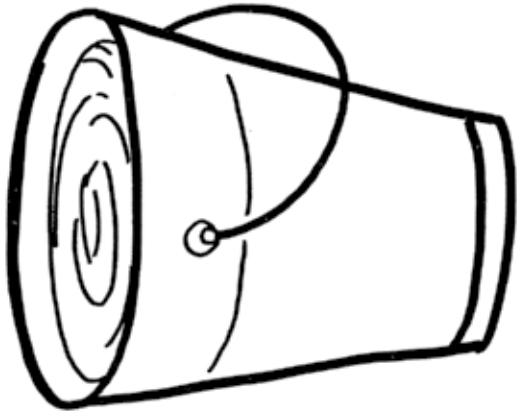

100 100

1000 1000

500 500





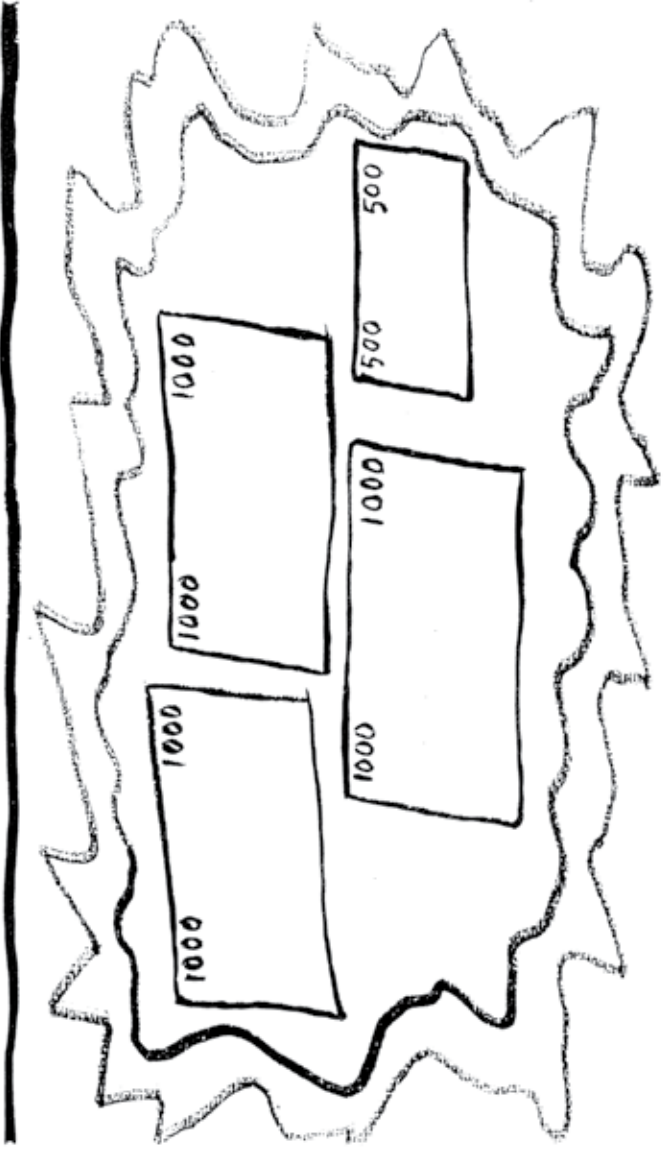
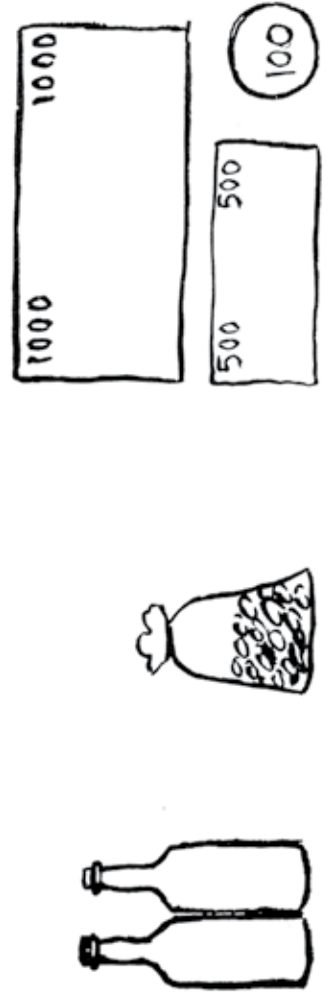
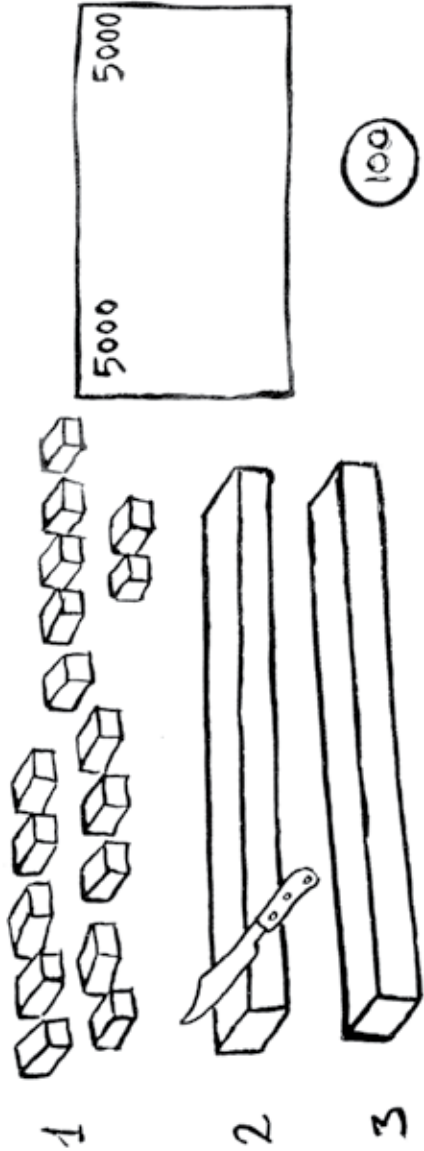

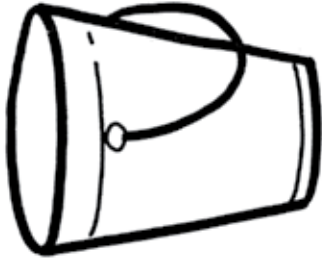
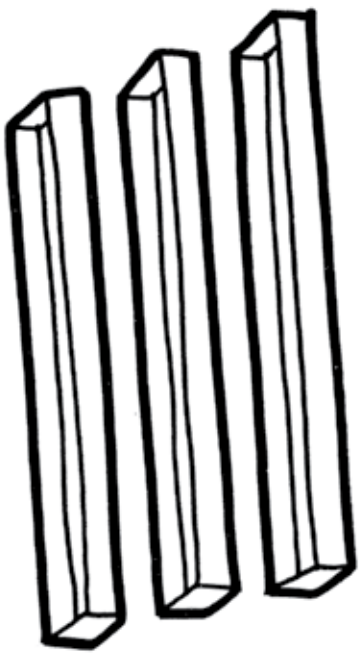
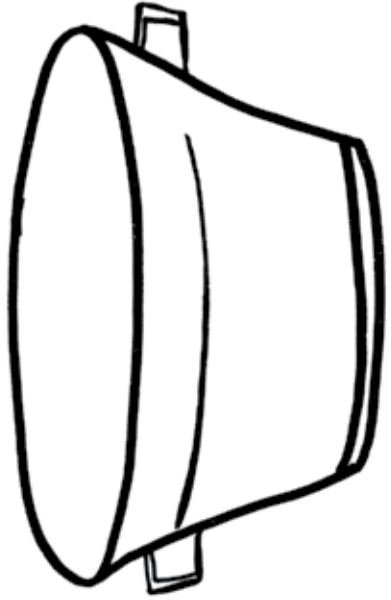

100

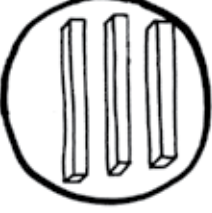
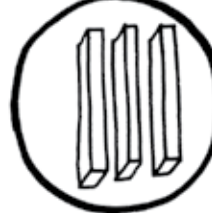

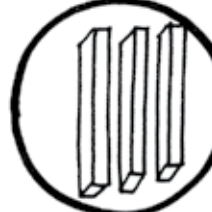

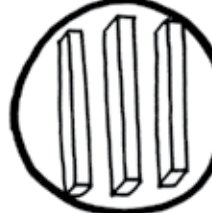





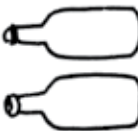
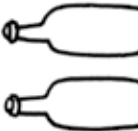
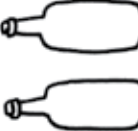
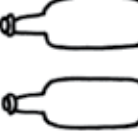
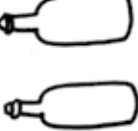



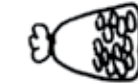

5900

					10,000
					10,000
					10,000
					10,000
					1,000

10,000	10,000
5000	5000
1000	1000

10,000	10,000	5000	5000
10,000	10,000		



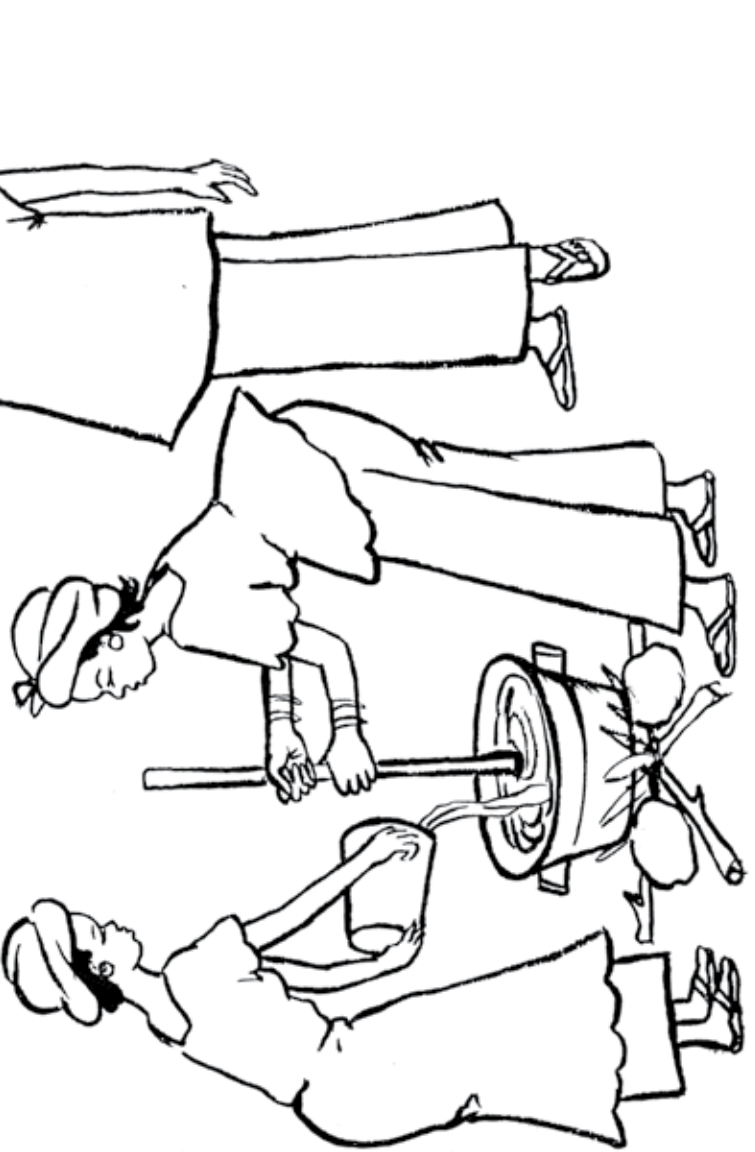
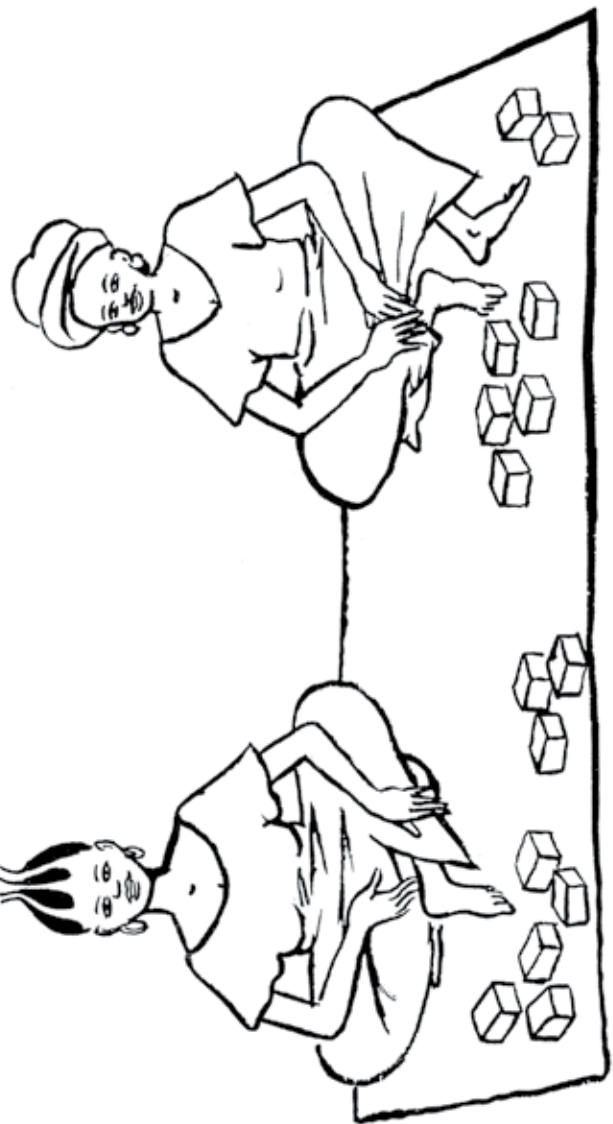

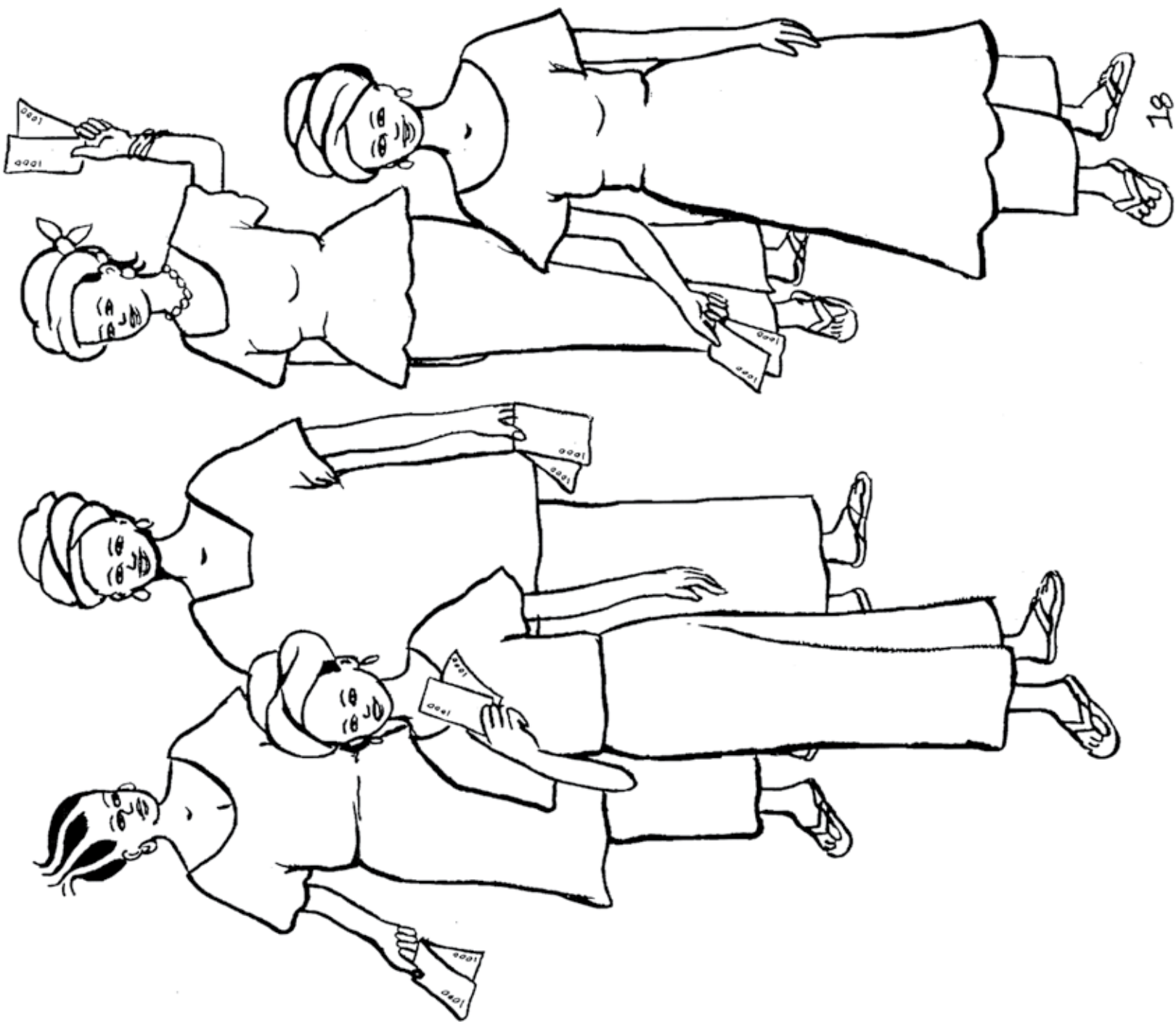

---

## Women, Ink...

The United Nations Development Fund for Women (UNIFEM) is pleased to announce the establishment of Women, Ink, a project to market and distribute women and development resource materials. Women, Ink. is supported by a major new UNIFEM communications programme whose mandate is to document and distribute information about UNIFEM's 15 years of experience working on women and development issues. The new programme also involves assisting partner organizations to document their experiences and exchange information.

Women, Ink. will distribute women and development resource materials published or produced by both UNIFEM and other women and development organizations. These will include books, journals, occasional papers, technical guides, training materials and videos. The new programme will also provide opportunities for Third World women and organizations to publish their experiences in an international arena.

As part of this initiative, UNIFEM was able to acquire the valuable publications of the Overseas Education Fund (OEF) International when that agency ceased operations in 1991. We are delighted to be able to give these very practically-oriented publications a new home, and will work towards extending their distribution and usefulness.

This, and the many planned initiatives of Women, Ink. will, we hope, help to respond to the enormous and fast growing demand for advocacy and learning materials among women at all levels of society in all parts of the world.



Sharon Capeling-Alakija  
Director  
United Nations Development Fund for Women

---

## Appropriate Business Skills for Third World Women

OEF's "Appropriate Business Skills for Third World Women" series makes years of "how to" experience readily available to trainers and programmers.

Throughout the Third World, women microentrepreneurs make a vital contribution to their families and national economies. Since 1978, OEF International has enabled low-income women in Africa, Asia, and Latin America to start businesses and make their businesses more profitable.

From pig producers in Honduras to rope makers in Sri Lanka to a soap-making cooperative in Senegal, OEF has assisted women to successfully plan, finance, manage, and promote many kinds of small businesses. All of these women had encountered similar obstacles to success: lack of awareness of non-traditional work options; lack of marketable skills; lack of access to credit; and lack of knowledge of ways to market and manage a business.

Through collaboration with local Third World organizations, OEF has developed three technical training manuals to help women entrepreneurs overcome these obstacles. Through learning by doing with women entrepreneurs, OEF has found what works.

The manuals are designed to be used by experienced trainers, extension agents, or programmers who work with Third World entrepreneurs. The training activities are based on the same participatory educational approach as in OEF's training manuals **Women Working Together for Personal, Economic and Community Development and Navamaga: Training Activities for Group Building, Health and Income Generation**. The material in the series is highly adaptable to groups that include men, to urban or rural settings, to different sizes of enterprises, and to illiterate or literate groups. The manuals may be used singly or as a series.

"Appropriate Business Skills for Third World Women" brings the experience of the field back to the field.