

Traditional field crops

Written by:

David Leonard

Edited by:

Marilyn Chakroff

Nancy Dybus

Illustrated by:

Marilyn Kaufman

This publication was produced for Peace Corps by the Transcentury Corporation, Washington, D.C.

Peace Corps

Information Collection & Exchange

December 1981

M0013

TRADITIONAL FIELD CROPS December 1981

Prepared for Peace Corps by the TransCentury Corporation under Contract No. 79-043-0129

Available through

Peace Corps/ICE

8th Floor

1990 K Street, NW

Washington, DC 20526

INFORMATION COLLECTION & EXCHANGE

Peace Corps' Information Collection & Exchange (ICE) was established so that the strategies and technologies developed by Peace Corps Volunteers, their co-workers, and their counterparts could be made available to the wide range of development organizations and individual workers who might find them useful. Training guides, curricula, lesson plans, project reports, manuals and other Peace Corps-generated materials developed in the field are collected and reviewed. Some are reprinted "as is"; others provide a source of field based information for the production of manuals or for research in particular program areas. Materials that you submit to the Information Collection & Exchange thus become part of the Peace Corps' larger contribution to development.

Information about ICE publications and services is available through:

Peace Corps

Information Collection & Exchange

1111 - 20th Street, NW

Washington, DC 20526

USA

Website: <http://www.peacecorps.gov>

Telephone : 1-202-692-2640

Fax : 1-202- 692-2641

Add your experience to the ICE Resource Center. Send materials that you've prepared so that we can share them with others working in the development field. Your technical insights serve as the basis for the generation of ICE manuals, reprints and resource packets, and also ensure that ICE is providing the most updated, innovative problem-solving techniques and information available to you and your fellow development workers.

This manual may be reproduced and/or translated in part or in full without payment or royalty. Please give standard acknowledgment.

About this manual

The Traditional Field Crops manual is designed as a learning tool and on-the-job reference for Peace Corps Volunteers involved in small farmer crop improvement programs in maize, sorghum, millet, peanuts, beans and cowpeas. Although written to be readily understood by non-specialists, the manual contains much information useful to trained agriculturalists and to planners and trainers.

Primarily designed to help Volunteers develop and strengthen the agricultural skills they need for successful work with the target crops, this manual focuses on the following areas:

- Surveying and interpreting the local agricultural environment and individual farm units
- Developing agricultural extension techniques and practices
- Providing basic "hands-on" and technical skills for extension workers in operations from farm land preparation through harvest, including some routine troubleshooting.

To do this, the manual provides a summary of current crop production recommendations under varying conditions of climate, soils, management ability, and available capital; identifies useful field references and other technical resources, including information on improvements in equipment for small farmer row crop production; and reviews recent research advances and extension efforts in target crop yield improvement with special emphasis on the role of international crop institutes. Scientific names are used along with common names to avoid confusion, as one common name may refer to a number of different species.

About the author

David Leonard has been associated with the Peace Corps off and on for the past eighteen years. Originally a B.A. generalist (history), he served as an agriculture extension Volunteer in Guatemala from 1963-65 and then went on to get a Master of Agriculture degree in agronomy from Oregon State in 1967. Since then, he has been an agriculture trainer for 35 groups of Peace Corps Volunteers bound for Latin America, Africa, and Asia. He also grew maize, potatoes and peanuts for three years on a 120-hectare farm in Australia.

Acknowledgments

I would like to express special thanks to John Guy Smith of Washington, D.C., for assistance in planning this manual and for permission to use materials from several of his publications. No one better understands the realities of small farmer agriculture and the development and introduction of improved farming practices.

Also, thanks are due to Trans-Century's Paul Chakroff, Marilyn Chakroff and Nancy Dybus for their editing assistance; to Marilyn Kaufman for her fine illustrations; and to Cade Ware for his excellent typing and layout of the final document.

1. Introduction

From 1961 to 1975, total food production in developing countries increased about 47 percent. This seemingly impressive gain was reduced to only 10 percent in terms of food production per person because of rapid population growth rates. In more than half of the developing nations, per person cereal grain production was less in 1979 than in 1970. Presently, some two-thirds of all people in the developing countries are considered undernourished.*

*Population and food data are based on figures from the Food and Agricultural Organization (FAO) of the United Nations (UN).

Current world food supplies compared with dietary requirements show only a minor deficit on paper, but the reality is far more serious for two reasons:

- Food supplies are distributed inequitably among countries, different income groups, and even within the family. Since the quantity and quality of food intake is strongly linked to income level, increases in per person food production will have little effect on hunger and malnutrition without a large rise in the incomes of the world's poor.
- Postharvest food losses of cereals and legumes (dry beans, peanuts, etc.) during processing and storage are conservatively estimated to be 10 percent on a world basis, but losses of 20 percent are common in developing countries.

Looking to the future, there is little reason for optimism. A 1974 UN study predicted that in the next 30 years, human population will increase by 26 percent in the developing countries, 62 percent, and 119 percent in the developed nations. The study concluded that if current food production trends continue in developing countries, they will need to increase their grain imports five-fold between 1970 and 1985. Aside from the problem of financing such imports, it is very questionable whether the major grain exporters can meet these needs.

It is not likely that developing countries can increase food production rapidly enough during this decade to achieve self-sufficiency. However, the food deficiency can be narrowed if these countries strengthen their recent interest in crop improvement practices and introduction of new techniques to both small- and large-scale farmers.

The small-scale farmer and agricultural development

The great majority of farmers in developing countries operate on a small scale. Despite much local and regional diversity, they share a number of important characteristics:

- Most small farmers operate as independent economic units, either as independent proprietors or under a rental arrangement allowing them to make production decisions. In some cases, however, individual decision-making may be subject to tribal or village controls, or restricted by insecure tenancy.
- Since they have a small amount of land and capital, they depend mainly on the family labor supply.
- The small-scale farmer is less likely than large-scale farmers to use capital for commercial inputs like fertilizers, pesticides, and equipment.
- The small farmer tends to use credit for consumption needs rather than for purchasing farming inputs.
- Compared to larger farmers, small farmers have limited access to important production factors associated with agricultural development such as agricultural credit and supplies, adapted technology, technical assistance, market information, roads, and transport.

Assisting small farmers

In the developing world, most small-scale farmers with whom the extension worker is in contact are farmers in transition from traditional to improved production practices. They are aware of outside inputs like fertilizers, insecticides, and vaccines for livestock and may actually be using one or more of these, though often in a haphazard manner. Although their first production priority is usually subsistence, there is a strong motivation to produce a marketable or exchangeable surplus once the family food needs are met.

Much of the solution to hunger and rural poverty in the developing countries hinges on the small farmer's ability to increase his or her returns from traditional crops by adopting appropriate improved production practices. "Appropriate" means in harmony with the environment and the cultural and economic situation of the farmer. "Improved" refers to the use of non-traditional inputs like fertilizers, agricultural chemicals, new equipment suited to small-scale farming, and technical advisory services. It does not imply the total abandonment of traditional growing practices but rather the incorporation of suitable new elements.

Most small-scale farmers will benefit by participating in agricultural development programs. Since nearly all of them want to increase their yields and incomes, they will adopt new techniques--if these offer a reasonable assurance of a meaningful return without excessive risk and the necessary inputs are available.

Until fairly recently, yield-improving technology was usually developed with little regard to the realities of the small farmer's situation. It is not surprising that these so-called "improved" practices often encountered a cool response. Crop production research and extension are becoming more attuned to the small farmer's needs, and there are numerous examples of successful yield-improving programs involving small farmers throughout the developing countries.

The Small Farm As a Viable Economic Unit

When yield-improving practices are used in developing countries, competitively low production costs can be realized over a wide range of farm sizes. Increasing the size of the farm alone is usually not the answer to production problems for all small farms, although it can be an important factor for some.

There are basically two types of small farm. One is the family-size farm, which can gainfully employ the equivalent of two to four adults and a team of oxen. This type of farm is much smaller in size and capital than its equivalent in the developed countries, probably because land and machinery are more expensive than labor in most developing countries.

The sub-family farm is too small to effectively employ the equivalent of two adults and a team of oxen. Unfortunately, in countries like Guatemala, El Salvador and Peru, up to 80-90 percent of the total farm units are classified as subfamily. The sub-family farm is too small to become economically successful no matter how much improved technology is used. In this case, increased size is vital to production.

The Availability Of Improved Production Practices

Since the 1960s, there has been a growing effort on the part of national and international crop research organizations to develop feasible yield-improving practices for the reference crops included in this manual. This is a long, ongoing process, but for many farming regions in developing countries there is now a group of improved practices that will provide significant increases in both yields and returns over traditional methods. These developments are the small farmers' best hope for increasing yields and returns so that they can remain (or become) competitive economically and improve their standard of living. The ideal conditions for promoting improved crop production practices among small farmers would ensure that:

- the new practice does not increase farmer risks, depart radically from current practices, or require considerable retraining of the farmer.
- the potential gains exceed the added costs by at least two to one. (This is the cost/ benefit ratio.)

- the commercial inputs and associated services required for the practice are readily obtainable on reasonable terms.
- The pay-off from the new practice occurs in the same crop cycle in which it is applied.
- The costs of the new practice are within the farmer's means. This usually implies access to credit.

All of these conditions are seldom fully met in small farmer agriculture in a developing country. Nonetheless, with a good extension service and a well-developed "package of practices", agricultural extension workers can improve crop yields on small farms dramatically.

The "Package" approach to improving crop yields

In most cases, low crop yields are caused by the simultaneous presence of several limiting factors, rather than one single obstacle. When a specially developed and adapted "package" of improved practices is applied to overcome these multiple barriers, the results are often much more impressive than those obtained from a single factor approach. A crop "package" consists of a combination of several locally proven new practices. (Few packages are readily transferable without local testing and modification.) Most include several of the following: an improved variety, fertilizer, improved control of weeds, pests, and diseases, improvements in land preparation, water management, harvesting, and storage.

The likelihood of a positive response is greatly increased using a package approach. However, there are possible disadvantages:

- If the package fails, farmers may conclude that all of the individual practices are unproductive.
- More adaptive research and extensive local testing are required to develop a proven package for an area.
- The package may favor the larger farmers who have easier access to credit for buying the added inputs.
- Unavailability of a component input or its faulty application may make the entire package fail.

It should be stressed that a package does not always have to involve considerable use of commercial inputs. In fact, an extension program can focus initially on improvement of basic management practices that require little or no investment such as weeding, land preparation, changes in plant population and spacing, seed selection, and timeliness of crop operations. This helps assure that small farmers benefit as least as much as larger ones, especially in those regions where agricultural credit is poorly developed.

The role of the extension worker

To work with small farmers to improve yields of the six reference crops (maize, sorghum, millet, peanuts, cowpeas, and beans), extension workers need both agricultural and extension skills. The general agricultural skills required by extension workers who will be involved in crop improvement projects as intermediaries with a limited advisory role include:

- understanding the need for crop improvement programs
- interpreting the agricultural environment
- knowledge of the reference crop characteristics
- knowledge of crop improvement practices
- understanding of reference crop management principles.

Extension workers also will need to have an appropriate level of "handson" and technical skills relevant to the reference crops, and an ability to adjust recommendations for variations in local soils, climate, management, and capital.

This manual provides most of the information extension workers need to work with the six reference crops. In promoting any crop improvement practice, however, it is very important to work with the local farmers, extension service, universities, and national and international agricultural research institutions. These individuals and organizations are much more familiar with the prevailing local environmental, economic, social and cultural conditions and should be consulted first before attempting any crop improvement program.

2. The agricultural environment

The purpose of this chapter is to identify how extension workers can survey and interpret important features of the local agricultural environment and the individual farm units which are a part of it. This is vital to effective extension since it enables workers to fully comprehend the area's farming systems and practices.

The local agricultural environment is made of up those factors which influence an area's agriculture. The most important of these are the natural (physical) environment and the infrastructure.

The natural environment

The natural environment consists of the climate and weather, the land and soils, and the ecology (the interaction among crops, weeds, insects, animals, diseases, and people).

Weather refers to the daily changes in temperature, rainfall, sunlight, humidity, wind and barometric pressure. Climate is the typical weather pattern for a given locality over a period of many years. To quote one definition, people build fireplaces because of the climate, and they light fires in the fireplaces because of the weather.

The climate and weather factors that have the greatest influence on crop production are solar radiation (sunlight and temperature), rainfall, humidity, and wind.

Solar Radiation

Solar radiation markedly influences crop growth in several ways:

- It provides the light energy needed for photosynthesis, the fundamental process by which plants manufacture sugars for use in growth and food production. Sugars are made by this process in the green cells of plants when carbon dioxide from the air combines with water from the soil using sunlight and chlorophyll (the green pigment in plants) as catalysts.
- The daily duration of sunlight (daylength) and its yearly variation greatly affect time of flowering and length of growing period in some crops.
- Solar radiation is the primary determinant of outside temperature, which strongly influences crop growth rate and range of adaption.

Regional and yearly variations in solar radiation

Unlike the temperate zone latitudes, the region between the Tropic of Cancer (23.5°N) and the Tropic of Capricorn (23.5°S) has relatively little seasonal variation in solar radiation, since the sun remains fairly high in the sky all year long. Measurements above cloud level show an annual variation in solar radiation of just 13 percent at the equator versus 300 percent at a latitude of 40°. However, this supposed advantage of the tropics may in some cases be largely offset by cloudiness, which can be excessive in the higher rainfall zones, particularly near the equator (cloudiness can reduce solar radiation by 14-80 percent depending on depth and extent of the cloud cover). For example, due to heavy cloud cover, the

equatorial Amazon Basin receives only about as much total yearly solar energy at ground level as the Great Lakes region of the U.S.

Daylength

The length of time from plant emergence to flowering as well as the actual date of flowering can be strongly affected by daylength in the case of some crops. Among the reference crops, soybeans and the photosensitive varieties of millet and sorghum are the most affected.

Maize is less influenced by daylength unless a variety is moved to a latitude where daylength is markedly different from that of its point of origin (see Chapter 3). Daylength is usually not a critical factor with peanuts, beans and cowpeas.

As shown by the table below, both latitude and season influence daylength. Note that the annual variation in daylength markedly decreases as the equator is approached.

Table 1 Length of Day in Various Northern Latitudes

Month	Equator	20°	40°
Dec.	12:07	10:56	9:20
Mar.	12:07	12:00	11:53
Jun.	12:07	13:20	15:00
Sep.	12:07	12:17	12:31

Temperature

Temperature is the major factor controlling a crop's growth rate and range of adaption. Each crop has its own optimum temperature for growth, plus a maximum and minimum for normal development and survival. Even varieties within a crop differ somewhat in their temperature tolerance. Excessively high daytime temperatures can adversely affect growth and yields by causing pollen sterility and blossom drop. In addition, the hot nights common in the tropics can reduce crop yields. This is because plants manufacture sugars for growth and food production by the daytime process of photosynthesis, but "burn up" some of this at night through the process of respiration. Since high nighttime temperatures increase the respiration rate, they can cut down on the crop's net growth.

Several factors affect an area's temperature pattern:

- Latitude--Seasonal temperature variations are pronounced in the temperate zone where solar radiation and daylength fluctuate considerably over the year. In the tropics, this seasonal temperature difference is much smaller. Nighttime lows are seldom below 10-30°C near sea level and are usually above 18°C. Seasonal variations become more pronounced as the distance from the equator increases.
- Elevation--Temperature drops about 0.65°C for each 100 meter rise in elevation. This greatly affects a crop's length of growing period as well as its adaptation to the area. For example, at sea level in Guatemala, maize matures in three to four months and the climate is too hot for potatoes; however, about 50 km away in the highlands (above 1500 m), maize takes five to ten months to mature and potatoes thrive.
- Topography, or the shape of the land surface, can cause differences in local weather and climate (micro-climates). A work area may have two or more distinct micro-climates.
- Cloud cover has a definite buffering effect on diurnal (daily) temperature variation. It will lower the daytime high but raise the nighttime low.
- Humidity exerts an effect similar to cloud cover on temperature. Humid air takes longer to heat up and cool off and therefore is subject to considerably less daily temperature variation than dry air.

Maximum shade temperature rarely exceeds 38°C under high humidity, while maximums of 54°C are possible under dry conditions.

Rainfall

In dryland (non-irrigated) areas of the tropics with year-round growing temperatures, rainfall is the major environmental factor that determines which crops can be grown, when they are planted, and what they will yield. Rainfall varies greatly from place to place (often within surprisingly short distances), especially around mountainous or hilly terrain. The dryland farmer is keenly aware of his area's seasonal rainfall distribution. This includes deviations from the normal cycle such as early or late rains, or unseasonable droughts. Too much rain, which can drown out the crop, delay harvest, and accelerate soil erosion, can be just as serious as too little. It may be too wet for plowing one day, yet too dry the following week for good seed germination.

When gathering rainfall data for an area, one should keep in mind that annual rainfall averages have little meaning. Seasonal distribution and reliability are far more important in terms of crop production.

For example, Ibadan, Nigeria is located in the transition zone between the humid and semi-humid tropics and receives about the same annual rainfall (1140 mm) as Samaru, Nigeria, which is located to the north in the savanna zone. Ibadan's rainfall is spread out over nine months from March to November in a bi-modal pattern (i.e., two rainy seasons with a drier period in between). The first season is long enough for a 120-day maize crop, although there is some periodic moisture stress. The second season is shorter, and soil moisture is usually adequate for only an 80-90 day crop. On the other hand, Samaru's equal rainfall is spread out over five months in a uni-modal pattern, providing for a single maize crop not subject to moisture stress.

From the example it is apparent that annual rainfall averages alone are not a dependable gauge of the rainfall in an area. The same goes for seasonal rainfall distribution. Although it gives a good general indication of the amount of moisture available for crop production, it does not tell the whole story. The amount of rainfall that actually ends up stored in the soil of a farmer's field for crop use depends on other factors such as water run-off and evaporation from the soil surface, and the soil's texture and depth.

When interpreting the rainfall pattern of a work area, it is good to remember that averages are somewhat misleading. Variations to the average can be expected even though the general seasonal distribution curve usually maintains a consistent shape (Figure 1).

Cropping cycles and how they relate to the rainfall pattern:

Cropping cycles are determined by using the cropping calendar (planting and harvest dates for crops involved), and are closely tied to the seasonal rainfall distribution. This can be seen by comparing the cropping calendar in the next column with the rainfall chart in Figure 1.

Crop Calendar, Managua Area of Nicaragua

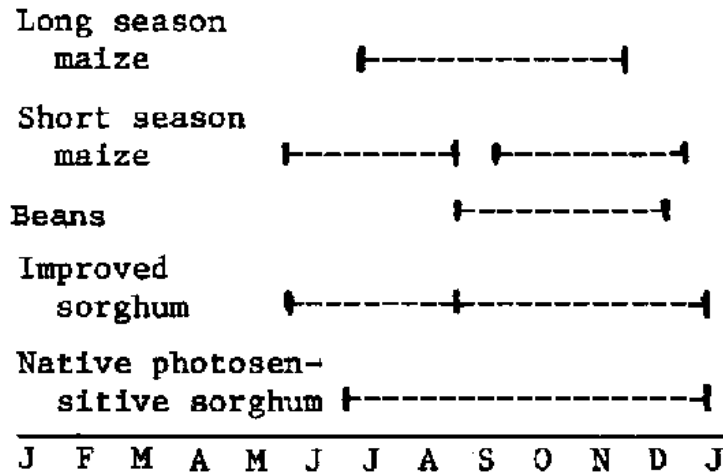

A primary source of rainfall information in a given area is the local farmer. Although official weather station rainfall data is handy to have if it is reliable and representative, it is not essential. Most of the information needed about rainfall distribution can be found by talking to experienced local farmers.

Figure 1 Monthly Rainfall Pattern, Managua, Nicaragua, 1958-67

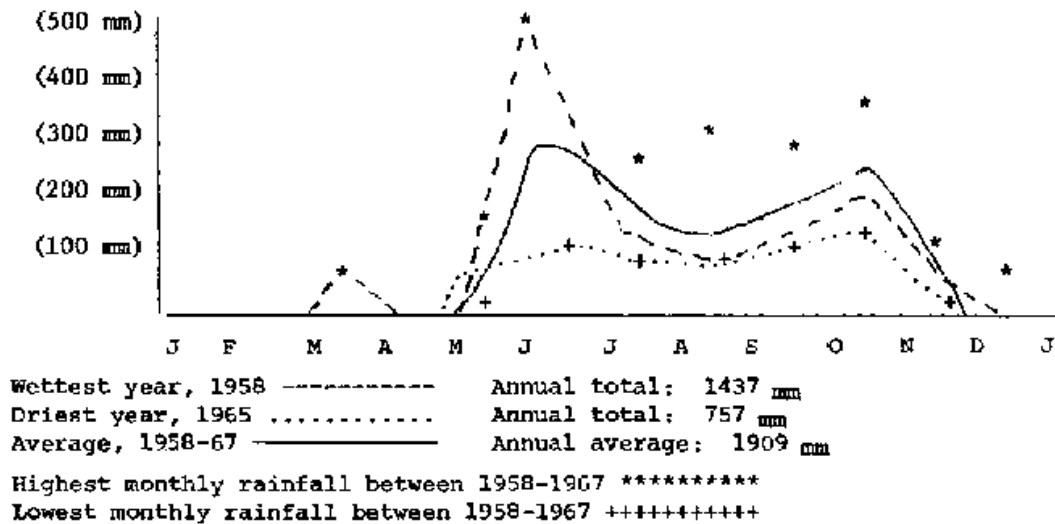

Humidity

Relative humidity affects crop production in several ways:

- Daily temperature variation is greater under low humidity; high humidity exerts a buffering effect on temperature.
- High humidity favors the development and spread of a number of fungal and bacterial diseases (see the disease section in Chapter 6).
- The rate at which crops use water is highest under hot, dry conditions, and lowest when it is very humid.

Wind and Storm Patterns

High winds associated with thunderstorms, hurricanes, and tornados can severely damage crops. Among the reference crops, maize, sorghum and millet are most prone to damage from heavy rain. Hot, dry

winds can markedly increase the water needs of crops. The frequency of high winds is also a factor that warrants investigation when surveying a work area's climate.

Topography

The shape of the land surface influences agriculture by causing local modifications in climate and weather and often is the major factor that determines the suitability of land for various types of farming. A work area may include several topographic features such as mountains, hills and valleys. Individual farms, too, often have significant topographic variations that affect crop production. Mountains and hills can greatly alter rainfall, and it is not uncommon to find a drier, irrigated valley on one side of a mountain range and a wetter, rainfed valley on the other side. Cold air usually settles in valleys, making them considerably cooler than the surrounding slopes. Steep slopes drain rapidly, but are very susceptible to erosion and drought, while flat or sunken areas often have drainage problems. Slopes angled toward the sun are warmer and drier than those angled away from it.

Soils

After climate and weather, soil type is the most important local physical feature affecting cropping potential and management practices. Most soils have evolved slowly over many centuries from weathering (decomposition) of underlying rock material and plant matter. Some soils are formed from deposits laid down by rivers and seas (alluvial soils) or by wind (loess soils).

Soils have four basic components: air, water, mineral particles (sand, silt and clay), and humus (decomposed organic matter). A typical sample of topsoil (the darker-colored top layer) contains about 50 percent pore space filled with varying proportions of air and water depending on how wet or dry the soil is. The other 50 percent of the volume is made up of mineral particles and humus. Most mineral soils contain about two to six percent humus by weight in the topsoil. Organic soils like peats are formed in marshes, bogs and swamps, and contain 30-100 percent humus.

Climate, type of parent rock, topography, vegetation, management and time all influence soil formation and interact in countless patterns to produce a surprising variety of soils, even within a small area. In fact, it is not uncommon to find two or three different soils on one small farm that differ widely in management problems and yield potential.

Important Soil Characteristics

There are seven major characteristics that determine a soil's management requirements and productive potential: texture, tilth (physical condition), water-holding capacity, drainage, depth, slope, and pH.

- Texture refers to the relative amounts of sand, silt and clay in the soil.
- Tilth refers to the soil's physical condition and capability of being worked.
- Water-holding capacity refers to the ability of the soil to retain water in its spaces.
- Drainage refers to the soil's ability to get rid of excess water and affects the accessibility of oxygen to roots.
- Depth is the depth of the soil to bedrock and the effective soil depth is the depth to which plant roots can penetrate.
- Slope is the inclination of the land surface, usually measured in percentage (i.e., number of meters change in elevation per 100 m horizontal distance).
- pH is a measure of the acidity or alkalinity of the soil on a scale of 0 to 14.

These characteristics are discussed in detail in Soils, Crops and Fertilizer Use, U.S. Peace Corps Appropriate Technologies for Development Manual #8, Parts I & II, by D. Leonard, 1969, and Crop Production Handbook, U.S. Peace Corps Appropriate Technologies for Development Manual #6, Unit I, 1969.

Ecology

For our purposes, ecology refers to the presence of, and interaction among, the reference crops, weeds, insects, diseases, animals (humans, wildlife and lives), and the environment in general. Agriculture is a perpetual contest with nature and farmers have developed many preventative and control measures, as well as special cropping systems, to give agriculture the advantage over natural succession. Each area will have its own combination of weeds, insects, diseases, and wildlife (including rats and grain-eating birds) that affect crop production. Identifying these and learning how farmers cope with them is crucial to understanding and dealing with the agricultural environment.

The effect of people and agriculture on the overall environment

Modern technology, land shortages, and increasing populations have increased agriculture's ability and need to "beat back" and manipulate nature. Often little thought is given to the possible environmental consequences of agricultural development. Potential ecological impacts of agricultural projects include:*

* For further information, refer to Environmentally Sound Small Scale Agriculture Projects, VITA, 1979.

- Deforestation
- Soil erosion
- Desertification
- Laterization
- Salinization
- Agrochemical poisoning of soil water, animals and people
- Flooding.

The infrastructure

The infrastructure, which refers to the installations, facilities, goods, and services that encourage agricultural production, consists of these elements:

- Local farming practices
- The physical infrastructure
- Land distribution and tenure
- Agricultural labor supply
- Incentives to farmers.

Local Farming Practices and Systems

Farming practices include:

- Land preparation - tillage methods, type of seedbed, and erosion control methods
- Planting - method, plant population and spacing, choice of variety
- Soil amendments - kind, amount, timing, placement of chemical or organic fertilizers and liming materials
- Control of weeds, insects, diseases, birds, rodents and nematodes (tiny, parasitic roundworms that feed on plant roots).
- Special practices such as irrigation or "hilling up" maize

- Harvest and storage methods.

The terms "cropping system" not only refers to the overall cropping calendar (planting and harvest dates for the crops involved) but more specifically to the actual crop sequences and associations involved, namely:

- Monoculture versus crop rotation - Monoculture is the repetitive growing of the same crop on the same land year after year. Crop rotation is the repetitive growing of an orderly succession of crops (or crops and fallow) on the same land. One crop rotation cycle often takes several growing seasons to complete (for example, maize the first two years, followed by beans the third and cotton the fourth).
- Multiple Cropping - There are two types of multiple cropping. One is sequential cropping, which means growing two or more crops in succession on the same field per year or per growing season. The other is intercropping, which is the most common definition of multiple cropping and involves the growing of two or more crops at the same time on the same field. See Chapter 4 for details on the different types of intercropping.

Due to differences in soils, climate, management ability, available capital, and attitudes, important differences in farming practices and systems may be found within a particular area.

The Physical Infrastructure

The physical infrastructure refers to the physical installations and facilities that encourage agricultural production such as transportation (farm-to-market roads, railroads), communications, storage and market facilities, public farm works (regional irrigation, drainage, and flood control systems), and improvements to the farm (fencing, wells, windbreaks, irrigation and drainage systems, etc.). All of these are important, but adequate and reasonably priced transport is especially critical since agriculture is a business that involves handling bulky materials. A farmer's distance from the road network is often the prime factor determining whether or not he or she can profitably use fertilizer or move his or her surplus crops to market.

Land Distribution And Tenure

In a settled area, all the agricultural land may be occupied. The land distribution and tenure situation in an area thus has enormous social and economic consequences and greatly affects farmer incentives. The two most important issues in this regard are:

- Who occupies the land and on what terms do they use it or allow others to use it?
- What is the ratio between the number of people dependent on farming for their livelihood and the amount and kinds of land available?

The Agricultural Labor Supply

The ratio of farmers and farm laborers to the amount and types of land provides a good indication of land use intensity. The existence of adequate farm labor for peak periods is another important consideration affecting farm practices and returns. For most of the year, many farming areas in developing countries have a generally high rate of agricultural underemployment, except during a few peak periods such as planting at the start of the rains or weeding time, if mechanical cultivation is not used. At these times, the scarcity of labor can become the most critical factor limiting production, and labor productivity assumes an unusual importance.

Incentives for Farmers

These can be very broadly interpreted, since they include equitable land tenure and distribution, adequate markets and prices for farm produce, and the existence of a viable improved technology.

Understanding the individual farm unit

Each farm has its own unique characteristics, but those located in the same area usually share enough similarities to allow grouping them into several general types of farm unit, such as subsistence, market-oriented field crop, plantation, etc. If an area's environment is fairly uniform, only one type of farm unit may predominate. If it is characterized by irregular topography and lopsided land distribution, the area may have two or more types of farm units.

There are eight basic criteria that can be used to differentiate types of farm units:

- Location
- Type of occupancy
- Size of farm, parcelling, and land use potential
- Size of the farm business
- Type of farm enterprise
- Production practices
- Farm improvements
- Farm labor supply.

Location

The principal factors here are:

- Natural characteristics such as soil type, slope, soil depth, drainage, access to water, etc.
- Proximity to the transportation network and other facilities such as public irrigation and drainage systems
- Location in relation to other farm units
- Local name of the farm's location.

Type of Occupancy

The principal considerations are:

- Who owns the land?
- If not owner-operated, what is the tenancy arrangement (i.e., cash rent, crop share, or work share) and on what specific terms? How secure is the arrangement?
- If no one has legal title to the land, is it occupied under squatters' rights that are protected by law?
- Who manages the farm unit and makes the basic decisions?

Size of Farm

- Total farm size in terms of local units of measure
- Location of farm parcels: If they are dispersed, how far are they from the farmer's house?
- Actual land use: tillable versus pasture versus forest; irrigated versus non-irrigated
- Characteristics of its soils: local name, color, texture, depth, drainage, slope, plus farmer's opinion of them.

Size of Farm Business

- Land value of the farm unit
- Value of other fixed assets
- Amount of operating capital employed per land or lives unit
- The value of production per land or lives unit. The value of the farm unit compared to its number of workers indicates whether it is capital-intensive (using machines and money to harvest) or labor-intensive (using human labor to perform farm operations). The value of production per land unit indicates the intensity of land use.

Type of Farm Enterprise

Some farms are engaged in only one enterprise such as growing sugarcane, coffee, rice, etc., but this type of monoculture is unusual among small farms. More likely, some form of mixed agriculture will exist. The main considerations are:

- Relative importance of each enterprise
- The yields obtained from each enterprise
- The disposal of the products from each enterprise (subsistence or cash sale) and where sold
- Crop rotations and associations
- Relationship between crop and lives production, if any.

Production Practices

- The specific factors used in agricultural development
- Rate, method, and time of application.

Farm Improvements

- Condition of the farm family home (or the farm manager's and farm workers' homes).
- Presence and condition of fences, wells, irrigation works, field access roads, storage facilities, lives shelters, corrals, etc.

The Farm Labor Supply

- Degree of reliance on the family's own labor force and the composition of that force
- Degree of dependence on hired labor
- The seasonal nature of work requirements
- Use of animal or tractor-drawn equipment.

Guidelines for the orientation of the extension worker

These guidelines are designed to help newly assigned agricultural field workers (AFW) orient themselves to the local agro-environment and its individual farm units within one or two months after arrival in the area. When using the guidelines, keep in mind the following:

- Do not undertake a highly detailed survey of local resources at the start of the assignment unless the host agency specifically requests it. Such a survey is likely to arouse local suspicions, especially if you are overzealous or overbearing with your initial contacts.
- The host agency may provide a basic orientation to the work area, but it may be very limited.
- If there are discrepancies between the information gathered from local sources (farmers, etc.) and that from outside or official sources, trust the local "grass roots" information until proven otherwise. Local farmers are the ultimate authorities on the local environment.
- The guidelines that follow are organized mainly by subject area but do not have to be followed in a set order. You will be picking up bits and pieces of information from a single informant that may deal with a number of areas, and you will have to put them into their proper context.

Introductory orientation

This initial phase focuses on the agricultural environment in general and is designed to help you familiarize yourself with it and adjust your work schedule and activities to the seasonal rhythm of the area's agriculture. Unless severely limited by your local language ability, you should be able to complete this phase in two to four weeks if you spend several hours a day talking with local farmers and other sources of agricultural information throughout the area.

Establish Communication

A major part of your time will be spent talking with and listening to farmers and other knowledgeable sources (local residents) who have a vested interest in agriculture.

Locate Farmers

- Get a general idea of how farmers are distributed geographically.
- Get a specific idea of where likely client farmers are located (i.e., those with whom your job description deals).

Locate Other Knowledgeable Individuals

Agricultural technicians stationed or working in the area, local buyers of farm produce, agricultural supply dealers, and truckers are good sources of information.

Select Reliable Local Sources

At the early stage, your contacts do not have to be completely representative so long as they are knowledgeable. The best farmer-informants are usually among the more progressive farmers. For example, a progressive small farmer will provide more information and insight into small farming operations than a larger-scale commercial farmer. Likely initial contacts are: your landlord's relatives, the local mayor or other local official, the more easily accessible and talkative farmers, or farmers who have worked with extension services for some time. Keep a careful record of all initial contacts.

How to Interview

- Introducing yourself - Ideally, you should have a third party make the initial contact and introduction. If this is not possible, be prepared with a practiced explanation of your presence. It is important that you emphasize that you are the learner at this stage.
- Suggested techniques - Allow the farmer to talk as spontaneously as possible. Any leading questions almost always get "yes" responses. Use a memorized interview schedule rather than a written one which is likely to inhibit responses. Avoid over-familiarity.

- It is generally not a good idea to take written notes in front of a farmer, although in some cases he may expect you (as a "technician") to do so. Some farmers may view written notes as having some possible connection with future tax collections, etc. It's best to wait until an unobtrusive moment such as the mid-day break to summarize information in written form.

Become Familiar With the Principal Physical Features

In order to locate farms, farmers, agricultural suppliers, etc., you should pinpoint their locations with reference to roads and trails and dominant topographic features. The principal physical and demographic features of the work area should also be located and understood. These include:

- Topographical features - altitude, streams, principal features (landmarks) recognized locally as reference points, valleys, farm and non-farm lands
- Communications (roads and trails) - seasonal access, distances, travel times-and modes of travel between points
- Demographic - locations of communities (and their local names), farmers
- Infrastructure - irrigation systems, drainage systems, agricultural supply stores, schools, extension offices, etc.

You can make a base reference map yourself which shows these features, relying on your own observations as well as road maps, geographic maps, or soil survey/land use maps available from government agencies and international or regional organizations working in the area.

Become Familiar With Climate and Weather Patterns

Sources of Information

- Weather station records - Obtain all available meteorological data from the official weather station nearest to your area of assignment. Its orientation value will depend on the station's proximity and how well it represents your area's conditions.
- Relief maps - Altitude is the main temperature determinant in the tropics; remember that for every 100 m rise in altitude, average (mean) temperature will drop about 0.65°C.
- Local farmers - Official weather data can be valuable, but it is not essential. Information about local climate and weather conditions can be learned from experienced local farmers.

You can draw a rainfall chart which is accurate enough for the initial orientation simply by systematically recording farmer's comments about the seasonal distribution of rainfall; the same can be done for seasonal temperature variation.

Climate and weather checklist

Make tables and/or charts showing the monthly distribution of rainfall using these criteria:

- Dry to wet scale: (See rain fall section, Chapter 2.)
- Rainfall frequency: the number of times it normally rains in a week or month

Risk factors associated with climate and weather (i.e., droughts, hail, high winds, flooding) can be established by having farmers recall bad crop years over a span of years. Be sure to distinguish weather factors from other causes such as insects and diseases.

As for temperature, be sure to record:

- Monthly temperature averages.
- Periods of significantly high or low temperatures.
- Occurrence of first and last killing frosts if applicable

Become Familiar With Prevailing Fanning Systems and Practices

Identify the major crop and lives enterprises in the work area. For each of the crop enterprises which predominates in the area, indicate the following and note any local variations:

- The growing season - Indicate the normal growing season and its variations (early-late), and make a cropping calendar using line bar graphs (see rainfall section, Chapter 2).
- Describe production practices - Do not confuse the practices recommended by extension with those generally accepted by farmers. Your interest is in the prevailing practices used by most of the farmers in the area. Make note of any significant differences among different groups of farmers.
- Describe the principal land preparation practices - Specify the earliest and latest dates of application and indicate what the practices are called locally. For example, in many areas of Central America, the practice of hilling up maize (throwing soil into the row) is called "apogue".
- Describe the kind and amount of inputs associated with the practice. This includes the amount applied, method and timing of application, and worker-days of labor.

Estimate yields and returns

At this stage of the orientation, it is not necessary to make a detailed account of costs and returns. Seeking such data can arouse local suspicions or fears of future tax levies. Rough estimates of production costs, and gross and net returns are sufficient.

- Record reported yields per unit of land.
- Record recent prices at normal time of sale.
- Multiply recent prices by approximate average yield to get approximate gross returns.
- Subtract approximate production costs from gross returns to obtain approximate net returns. There are two ways to do this: net return to capital, land, and family labor where the only labor costs you account for are hired labor, or net return to land and capital in which case an opportunity cost (exchange value) must be assigned to family labor and subtracted from the gross return. The first way is the easiest.

Indicate the relative tendencies of production

- Estimate the percentage of the crop that is marketed.
- Identify the principal local market outlets (buyers).
- Indicate the seasonal movement of production off the farms: is it sold at harvest, some sold at harvest, some held for higher prices, etc.?
- Indicate the seasonal price fluctuations (average over several years).

List the outside production inputs which are available locally. ("Available" means when needed.)

- Crop production supplies (give brands, grades, and unit prices): fertilizers, insecticides, fungicides, herbicides, hand tools, hand-operated equipment, seeds, etc.

- Agricultural machinery and equipment (if used): tractors (horsepower and make), implements, irrigation pumps, etc.
- Services: such as custom machinery services and rates charged, and professional services (indicate whether public or private), technical assistance and soil testing, etc.

Summarize the Information

Every area's agriculture is tuned to a time schedule or seasonal rhythm to which work schedules and activities must be adjusted. Getting oriented in time is vital to effective agricultural extension. The best way to do this is to summarize the initial phase of orientation by making graphs and calendar charts that show the area's seasonal rhythm of climate, agriculture, and social life. The following graphs, charts, and observations were made by a group of Peace Corps Volunteers assigned as rural credit agents in the Pacific region of Nicaragua during an orientation-training exercise. The principles involved apply worldwide.

Make a generalized climate and weather calendar

Chart the normal monthly distribution of rainfall as related by farmers using terms such as wet, dry, some rain, wettest time, rainfall drops off, etc. There are three ways to do this:

1. Use the frequency of rainfall to measure seasonal distribution (see chart above).
2. Use a dry-to-wet scale.
3. Measure rainfall, if you have access to reliable meteorological data. Indicate the range and frequency of possible deviations from normal rainfall patterns from information passed on to you from farmers, or recorded by a weather station. (See chart above.)

Frequency of Rainfall

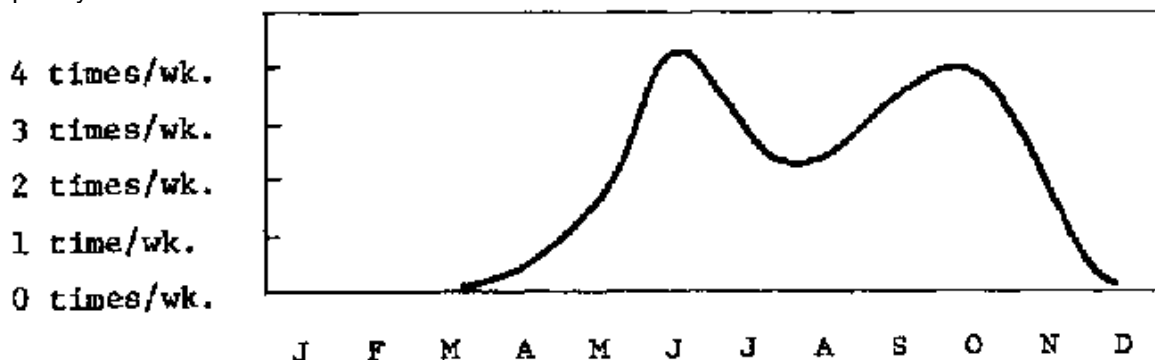

Make a calendar of agricultural activity.

For each of the major crop enterprises, display the length and possible range of growing season, including likely variations in planting and harvest times.

Indicate the time for performing critical operations and relative labor requirements of those operations.

Example: Crop Calendar, Crops and Order of Importance in the Esteli Area of Nicaragua

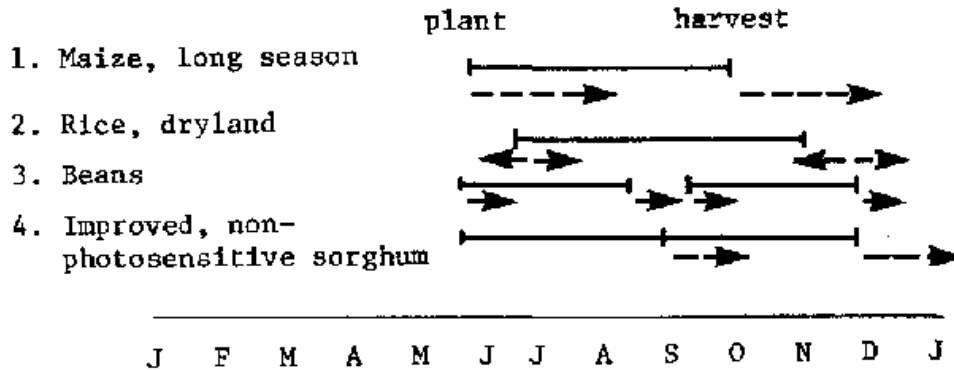

Example: Distribution of Work and Timing of Principal Farming Operations in the Esteli Area of Nicaragua

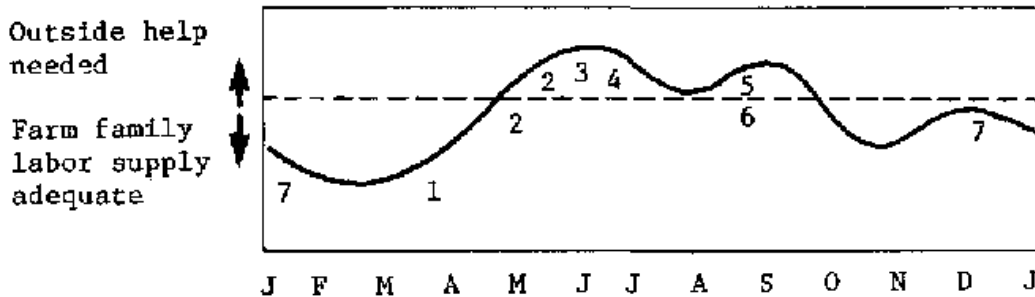

- 1. Land clearing
- 2. Land preparation
- 3. Principal seeding
- 4. Weeding
- 5. First harvest
- 6. Second harvest
- 7. Harvest

Indicate the relative seasonal labor demand, whether there are any periods of labor movement into or out of the area.

Determine the seasonal demand for other critical inputs: keep in mind an input is not considered critical unless farmers feel it is. (For example, if fertilizer is not generally used, it is not presently a critical input.)

Make a calendar of economic activity related to agriculture.

Indicate relative demand for short-term production credit. (See example below.) Indicate seasonal marketing patterns (the rate at which the crop is marketed).

Graph the seasonal range of prices.

Make a calendar of social activity that includes religious holidays and other holidays or seasonally determined social obligations.

The summary concludes the initial orientation phase. With a good understanding of the local agricultural environment and farming practices, you are ready to move on to the next step: orientation to the individual farm unit.

Example: Demand for Production Credit, Branch Office of the National Bank of Nicaragua

Number of
Credit
Applications
per Month



Orientation to the farm unit

Learning to communicate effectively with individual farmers about their farm enterprises and their farm businesses will help move you out of the questioning stage into a more active role. Expressing an interest in and being knowledgeable about the farm business can be the means as well as the purpose of communicating with farmers and will definitely increase your rapport and credibility with them.

Describe Typical Farm Units

Make a general farm profile which is representative for each of the types of farm unit with which you will be working.

Describe the Annual Agricultural Cycle as Perceived By the Farmer

For each type of farm unit with which you are likely to work, make an annual diary which indicates:

- Normal operations by months or seasons
- The decisions which the farmer has to make that are related to these operations
- The farmer's concerns throughout the year, such as the timing of the rains, dry spells, bird damage to crops, flooding, obtaining inputs, completing operations in time, etc.

3. An introduction to the reference crops

There are several reasons why the six reference crops -maize, grain sorghum, millet, peanuts, field beans, and cowpeas -are grouped together in one manual. All of the reference crops are row crops (grown in rows) and because of this, they share a number of similar production practices. Also, in developing nations, two or more of the crops are likely to be common to any farming region and are frequently interrelated in terms of crop rotation and intercropping (see Chapter 4) In addition, all of them are staple food crops. The developing countries are major producers of the reference crops, with the exception of maize.

Cereal crops versus pulse crops

Maize, grain sorghum, and millet are known as cereal crops, along with rice, wheat, barley, oats, and rye. Their mature, dry kernels (seeds) are often called cereal grains. All cereal crops belong to the grass family (Gramineae) which accounts for the major portion of the monocot (Monocotyledonae) division of flowering (seed-producing) plants. All monocot plants first emerge from the soil with one initial leaf called a seed leaf or cotyledon.

Germinating maize seed

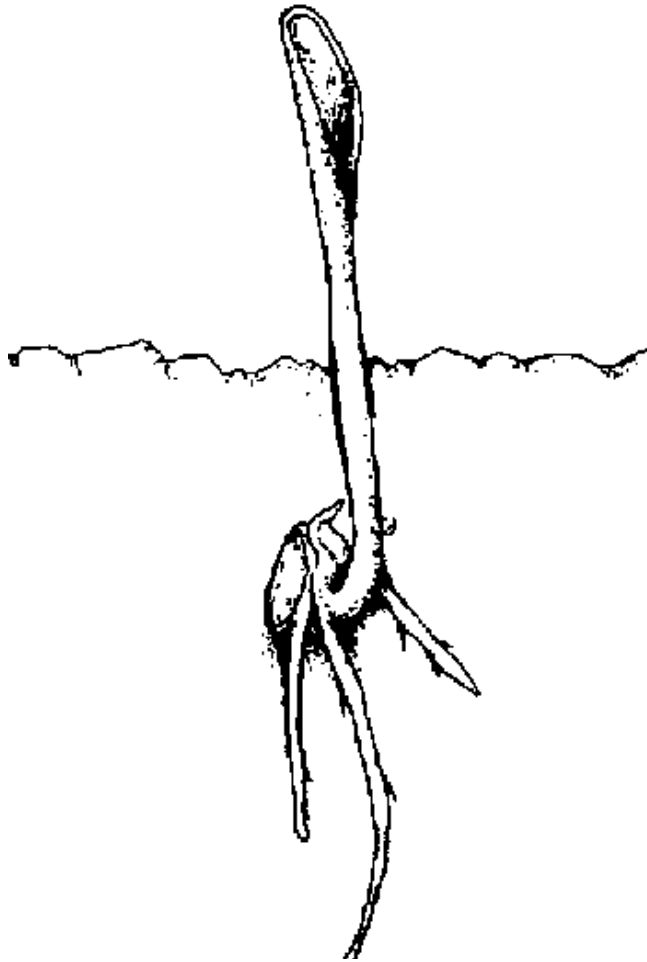

A germinating maize seedling; note that it has only one seed leaf, which makes it a monocot. Monocots emerge through the soil with a spike-like tip. They generally have fewer problems with clods and soil dusting than dicots.

Peanuts, beans, and cowpeas are known as pulse crops, grain legumes or pulses, along with others such as lima beans, soybeans, chickpeas, pigeonpeas, mung beans, and peas. The pulses belong to the legume family (Leguminosae) whose plants produce their seeds in pods. Some legumes like peanuts and soybeans are also called oilseeds because of their high vegetable oil content.

Table 2 World and Regional Production of the Reference Crops (1977 FAO data)

Crop	Total World Production (millions of metric tons)	Percent of World Production Countries	of World Developing Countries	Developed Countries
MAIZE	350.0	32.4		67.6
GRAIN SORGHUM	55.4	59.9		40.1
MILLET	42.9	95.1		4.9
PEANUTS (Groundnuts)	17.5	88.2		11.8
FIELD BEANS, COWPEAS	12.9	86.1		13.9

Geminating bean seed

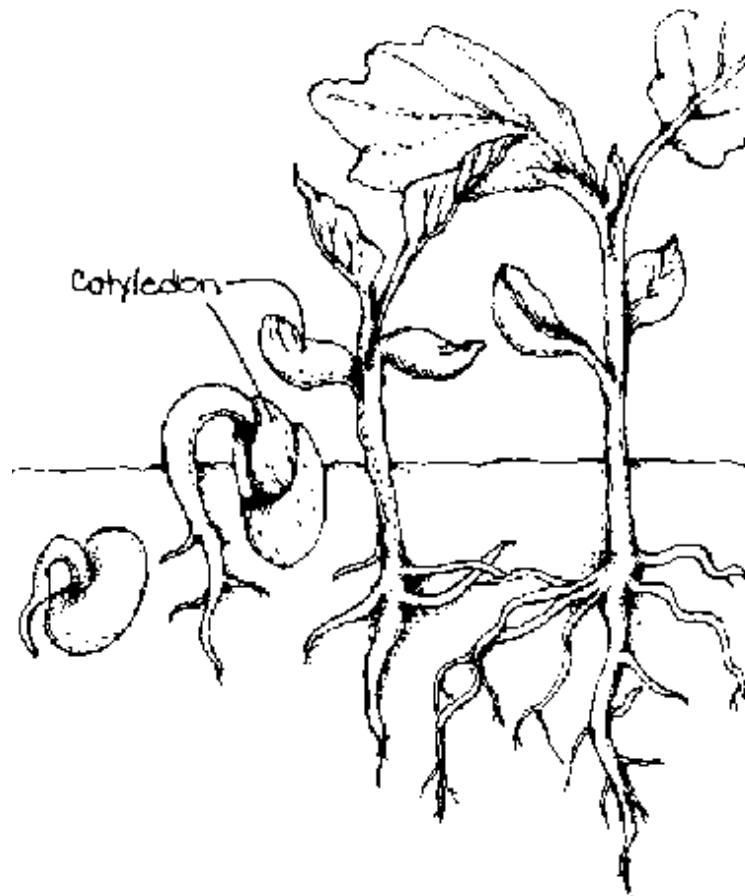

A germinating bean plant; note the two thick cotyledons (seed leaves) which originally formed the two halves of the seed.

The pulses belong to the other major division of flowering plants called dicots (Dicotyledonae). Unlike the monocots, dicot plants first emerge from the soil with two seed leaves.

In addition, the pulses have two outstanding characteristics for farmers and for those who consume them:

- They contain two to three times more protein than cereal grains (see Table 3)
- Legumes obtain nitrogen for their own needs through a symbiotic (mutually beneficial) relationship with various species of Rhizobia bacteria that form nodules on the plants' roots.

Nitrogen is the plant nutrient needed in the greatest quantity and is also the most costly when purchased as chemical fertilizer. The Rhizobia live on small amounts of sugars produced by the legume and, in return, convert atmospheric nitrogen (ordinarily unavailable to plants) into a usable form. This very beneficial process is called nitrogen fixation. In contrast, cereal grains and other non-legumes are totally dependent on nitrogen supplied by the soil or from fertilizer.

Nitrogen-fixing nodules on the roots of a bean plant. Note that they are attached to the roots rather than an actual part of them.

Nitrogen fixing nodules

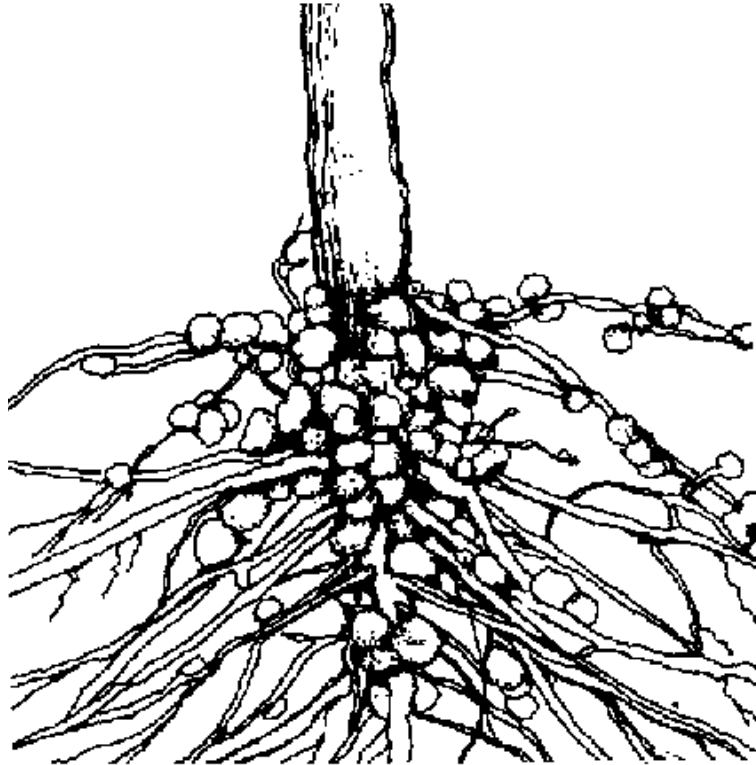

Despite the urgent need to increase both cereal and pulse production in the developing countries, most crop improvement efforts of the "Green Revolution" emphasized the cereals. As a result, pulse yields in the region have shown little, if any, increase. In some areas, total pulse production has actually declined in favor of the cereal grains, even though many developing nations suffer from a chronic protein shortage. Fortunately, this situation is now being reversed.

The nutritional value of the reference crops

The cereal grains, with their high starch content and lower prices, make up a major source of energy (calories) in developing countries. There, cereal consumption is high enough to contribute a substantial amount of protein to the diets of older children and adults (although still well below quantity and quality requirements). Another plus is that cereal grains contain a number of vitamins and minerals, including Vitamin A which can be found in the yellow varieties of maize and sorghum. gained from eating large quantities of the cereals, their protein content is relatively low (7-14 percent) and they are deficient in several amino acids. Infants and children, who have much higher protein needs per unit of body weight and smaller stomachs, do not get as much protein from cereals as adults. Studies have also shown that some reference crops lose vitamins and protein in substantial amounts with traditional preparation methods (milling, soaking, and drying).

The pulses have considerably higher protein contents than the cereal grains (17-30 percent in the reference pulses) and generally higher amounts of B vitamins and minerals. Unfortunately they also may have some deficiencies in amino acids.

All animal proteins (meat, poultry, fish, eggs, milk and cheese) are complete proteins (contain all essential amino acids), but their high cost puts them out of reach of much of the population in developing nations.

Fortunately, it is possible to satisfy human protein requirements without relying solely on animal protein sources. The cereals and pulses, though not complete proteins in themselves, can balance out each other's amino acid deficiencies. Cereals are generally low in the essential amino acid lysine, but relatively

high in another, methionine. The opposite is true for most of the pulses. If eaten together or within a short time of each other and in the right proportion (usually about a 1:2 ratio of pulse to cereal), combinations like maize and beans or sorghum and chickpeas are complete proteins. In most developing countries, however, pulses are more expensive than the cereal grains, which creates difficulties in achieving a balanced diet.

Table 3 Nutritional Value of the Reference Crops (dry weight basis)

Crop	Percent Protein	Calories/100 grams	Calories/lb.
MAIZE	8-10	355	1600
GRAIN SORGHUM	7-13	350	1600
MILLET (Pearl)	10-13	330	1500
COMMON BEANS	21-23	340	1550
COWPEAS	22-24	340	1550
PEANUTS (GROUNDNUTS)	28-32	400	1800

An introduction to the individual crops

Maize (*Zea mays*)

Distribution and Importance

In terms of total world production, maize and rice vie for the number two position after wheat. Several factors account for the importance of maize:

- Maize can adapt to a wide range of temperature, soils and moisture levels and resists disease and insects.
- It has a high yield potential.
- It is used for both human and animal consumption.

Types of Maize

There are five principal types of maize:

- Dent: The most widely grown type in the U.S. The seed has a cap of soft starch that shrinks and forms a dent at the top of the kernel.
- Flint: Widely grown in Latin America, Asia, Africa and Europe. The kernels are hard and smooth with very little soft starch. It is more resistant to storage insects like weevils than dent or floury maize.
- Floury: Mainly soft starch and widely grown in the Andean region of South America. It is more prone to storage insects and breakage than harder types.
- Pop: Really an extreme form of flint maize.
- Sweet: At least twice as high in sugar as ordinary maize and meant to be consumed in immature form when only about one-third the potential grain yield has been accumulated. It is more prone to field insect damage, especially on the ears.

Maize tassel, ear of maize

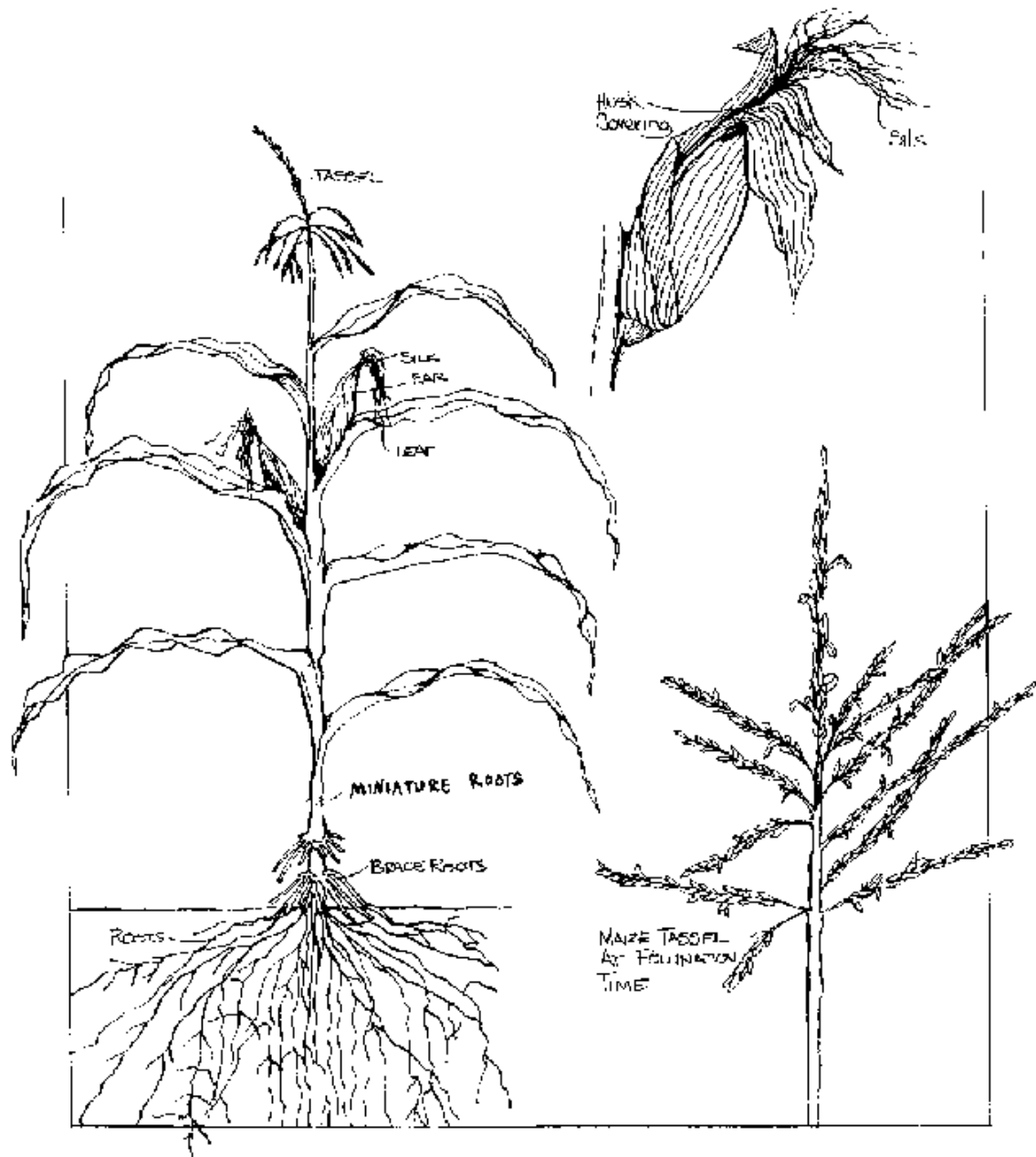

An ear of maize. Each silk leads to an ovula (potential kernel) on the cob. Varieties vary in length and tightness of husk covering, which determines resistance to insects and moisture-induced molds which may attack the ear in the field.

Parts of young maize plants

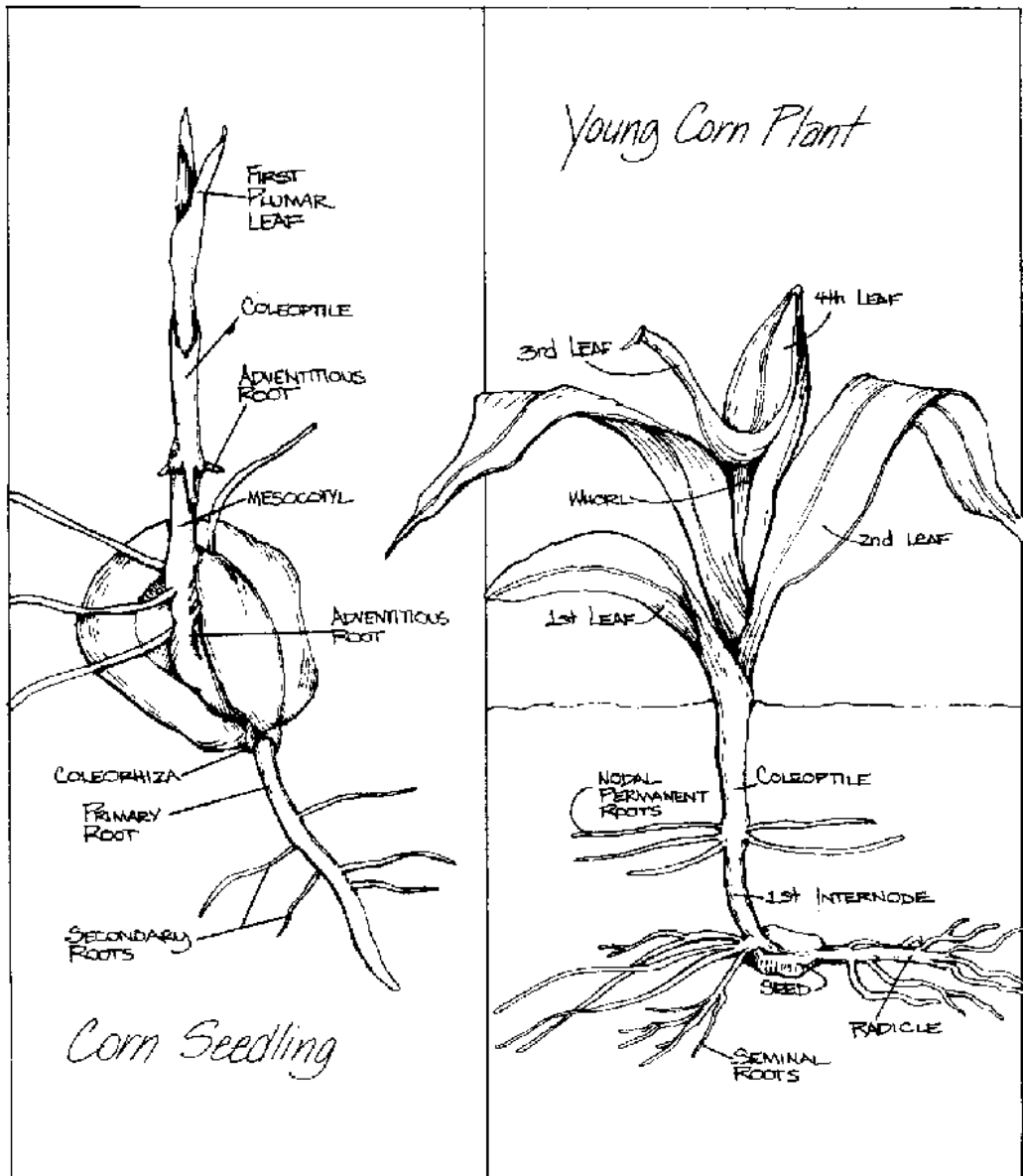

A potentially very valuable type called hi-lysine maize with more than double the content of lysine is nearing the mass application stage, but still has some field and storage problems to overcome (see the section on maize improvement at the end of this chapter).

Average Yield of Shelled Grain

	lbs./acre	kg/hectare
Top farmers in the U.S. Corn Belt	9,000-12,000+	10,000-13,500
U.S. Average	5,050	5,700
Average for developed countries	4,200	4,700
Average for LDC's	450-1,350	500-1,500
Feasible yield for small scale LDC farmers with improved practices	3,500-5,500	4,000-6,000

Source: FAO and USDA data, 1977.

Maize Yields

Average yield of shelled grain (14 percent moisture) under varying conditions are shown below.

Climatic Requirements of Maize

Rainfall: Non-irrigated (rainfed) maize requires a minimum of around 500 mm of rainfall for satisfactory yields. Ideally, the bulk of this should fall during the actual growing season, although deep loamy or clayey soils can store up to 250 mm of pre-season rainfall in the future crop's root zone. Any of the following factors will act to increase the moisture needs of maize (and other crops):

- Long growing periods due to cool temperatures.
- Shallow and/or sandy soils with low water-holding ability.
- Excessive water runoff due to lack of erosion control on sloping land.
- Low humidity, especially when combined with wind.

Maize has some ability to resist dry spells but is not nearly as drought-tolerant as sorghum and millet.

Temperature: The optimum growth rate of maize increases with temperatures up to about 32-35°C if soil moisture is abundant, but decreases slightly with temperatures around 27-30°C when soil moisture is adequate. If soil moisture is low, the optimum growth rate temperature drops to 27°C or below. At temperatures of 10°C or below, maize grows slowly or not at all and is susceptible to frost. However, daytime temperatures in excess of 32°C will reduce yields if they occur during pollination.

Yields are also reduced by excessively high nighttime temperatures, since they speed up the plant's respiration rate and the "burning up" of the growth reserves.

Soil requirements: Maize grows well on a wide variety of soils if drainage is good (no water-logging). It has a deep root system (up to 185 cm) and benefits from deep soils which allow for improved moisture storage in dry spells. The optimum pH for maize is in the 5.5-7.5 range, although some tropical soils produce good yields down to a pH of 5.0 (very acid). The liming and nutrient needs of maize are covered in Chapter 5.

Response to Daylength: The length of growth period of many plants is affected by daylength. This is known as a photosensitive (photoperiodic) response. Most maize varieties are short day plants which means that they will mature earlier if moved to a region with significantly shorter daylengths than they were bred for. In the tropics, there is relatively little variation in daylength during the year or between regions. Because most temperate zone maize varieties are adapted to the longer daylengths of that area's summer, they will flower and mature in too short a period for good yield accumulation if moved to the tropics. Sweet maize seed from the temperate zone may reach little more than knee height in the tropics, and produce disappointingly small ears, although in record time! Likewise, the "giant" novelty maize advertised in some gardening magazines is nothing more than a variety adapted to the very short daylengths of the tropics. When grown in the temperate zone, the much longer daylengths retard maturity and favor vegetative growth. Some maize varieties, however, are day neutral with little response to variations in daylength.

As mentioned earlier, maize's relatively low protein and high starch content makes it more important as an energy (calorie) source. Many people believe that yellow maize has more protein than white maize, but the only nutritional difference between the two is the presence of Vitamin A in the yellow variety (also called carotene).

Unlike production in the developed countries, maize production in developing countries is almost entirely used for human food in the form of meal, flour, tortillas or a thick paste. In humid areas where increased spoilage problems make grain storage more difficult, a significant portion of maize may be consumed much like sweet corn while it is still in the semi-soft, immature stage.

Maize has numerous industrial and food uses in the form of some 500 products and by-products. Various milling and processing methods can produce starch, syrup, animal feed, sugar, vegetable oil, dextrine, breakfast cereals, flour, meal, and acetone. Maize also is used for making alcoholic beverages throughout the world.

Maize Stages of Growth

Depending on the variety and growing temperatures, maize reaches physiologic maturity (the kernels have ceased accumulating protein and starch) in about 90-130 days after plant emergence when grown in the tropics at elevations of 0-1,000 meters. At higher elevations, it may take up to 200-300 days. Even at the same elevation and temperature, some varieties will mature much earlier than others and are known as early varieties. The main difference between an early (90-day) and a late (130-day) variety is in the length of time from plant emergence to tasseling (the vegetative period). This stage will vary from about 40 to 70 days. The reproductive period (tasseling to maturity) for both types is fairly similar and varies from about 50 to 58 days. The following discussion describes the growth stages and related management factors of a 120-day maize variety.

PHASE I: FROM GERMINATION TO TASSELING

Plants will emerge in four to five days under warm, moist conditions but may take up to two weeks or more during cool or very dry weather. Little if any germination or growth occurs at soil temperatures below 13°C. Harmful soil fungi and insects are still active in cool soils and can cause heavy damage before the seedlings can become established. Fungicide seed treatments (see Chapter 6) are usually most beneficial under cool, wet conditions and may increase yields from 10 to 20 percent.

Maize seeds are large and contain enough food reserves to sustain growth for the first week or so after emergence. Then the plants must rely on nutrients supplied by the soil or fertilizer. Up until knee-high stage, the three major nutrients -nitrogen, phosphorus, and potassium - are required in relatively small amounts, but young seedlings do need a high concentration of phosphorus near their roots to stimulate root development.

The primary roots reach full development about two weeks after seedling emergence and are then replaced by the permanent roots (called nodal roots) which begin growing from the crown (the underground base of the plant between the stem and the roots). Planting depth determines the depth at which the primary roots form but has no effect on the depth at which the permanent roots begin to develop.

Until the plants are knee high, the growing point (a small cluster of cells from which the leaves, tassel, and ear originate) is still below the soil surface, encased by a sheath of unfurled leaves. A light frost or hail may kill the above-ground portion of the plant, but usually the growing point (if below ground) will escape injury, and the plant will recover almost completely. However, flooding at this stage is more damaging than later on when the growing point has been carried above ground by the stalk.

The growing point plays a vegetative role by producing new leaves (about one every two days) until the plants are knee high; then a major change occurs. Within a few days, the underground growing point is carried above ground by a lengthening of the stalk and switches from leaf production to tassel initiation within the plant. (Slit a plant lengthwise at this stage, and you can easily see the growing point as a peaked tip inside the stalk). At this time roots from adjacent rows have reached and crossed each other in the between-row spaces (for rows up to one meter wide).

From tassel initiation until tassel emergence takes about five to six weeks and is a period of very rapid growth in plant height, leaf size, and root development. Maximum root depth can reach 180 cm. under optimum soil, moisture, and fertility conditions and is attained by the time of tassel emergence.

Maximum nutrient uptake occurs from about three weeks before to three weeks after tasseling and maximum water use from tasseling through the soft-dough stage (about three weeks after tasseling).

PHASE II: TASSELING AND POLLINATION

Tasseling occurs about 40-70 days after plant emergence in 90-130 day varieties. The tassel (flower) is thrust out of the leaf whorl about one to two days before it begins shedding pollen. Pollen shed starts two to three days before the silks emerge from the ear tip and continues for five to eight days. If conditions are favorable, all the silks emerge within three to five days and most are pollinated the first day.

Each silk leads to an ovule (a potential kernel). When a pollen grain lands on a silk, it puts out a pollen tube that grows down the silk's center and fertilizes the ovule at the other end in a matter of hours. Shortage of pollen is rarely a problem since about 20,000-50,000 pollen grains are produced per silk. Poor ear fill (the number of kernels on an ear) or skipped kernels are nearly always caused by delayed silk emergence or by ovule abortion, both of which are caused by drought, overcrowding or a shortage of nitrogen and phosphorus. Extreme heat (above 35°C) can diminish pollen vigor and also affect ear fill. Some insects like the corn rootworm beetle (*Diabrotica* spp.) or Japanese beetle (*Popillia japonica*) can cut off the silks before pollination.

Maize is cross-pollinated, and usually 95 percent or more of the kernels of a cob receive their pollen from neighboring maize plants. This also means that different maize types such as the hi-lysine varieties must be kept isolated from other maize pollen if they are to retain their desired characteristics.

Pollination is a very critical time during which there is a high demand for both water and nutrients. One to two days of wilting during this period can cut yields by as much as 22 percent and six to eight days of wilting can cut yields by 50 percent.

A few days after pollination, the silks begin to wilt and turn brown. Unpollinated silks will remain pale and fresh looking for several weeks but as mentioned above, they can only receive pollen for a week or so after they emerge from the ear tip.

PHASE III: FROM KERNEL DEVELOPMENT TO MATURITY

Most maize ears have 14-20 rows with 40 or more ovules per row and produce about 500-600 actual kernels. Any shortage of water, nutrients, or sunlight during the first few weeks of kernel development usually affects the kernels at the tip of the ear first, making them shrivel or abort. Maize is very prone to moisture stress (water deficiency) at this stage due to a heightened water requirement (up to 10 mm per day under very hot and dry conditions).

Wind damage during early kernel development is seldom serious, even though the plants may be knocked almost flat, since they still have the ability to "gooseneck" themselves (curve up) into a nearly vertical position.

Stages of Kernel Development in Maize

- Blister stage: About 10 days after pollination when the kernels begin to swell, but contain liquid with very little solid matter.
- Roasting ear stage: About 18-21 days after pollination. Though field maize has a much lower sugar content than sweet maize, at this stage it is still sweet. At this stage the kernels have accumulated only about one-third of the total dry matter yield they will have at physiologic maturity. From this time on, any type of stress is more likely to affect kernel size rather than grain fill at the ear tip.
- Dough stage: About 24-28 days after pollination.
- Approaching maturity: As maturity nears, the lower leaves begin to turn yellow and die. In a healthy, well nourished plant, this should not occur until the ear is nearly mature. However, any serious stress factordrought, low soil fertility, excessive heat, diseases--can cause serious premature leaf death. Ideally, most of the leaves should still be green when the husks begin to ripen and turn brown. Early death of the maize plant can greatly reduce yields and result in small, shrunken kernels.

- **Physiologic maturity:** About 52-58 days after 75 percent of the field's ear silks have emerged. The kernels have reached their maximum yield and have ceased accumulating more dry matter. However, they still contain about 30-35 percent moisture which is too wet for damage-free combine harvesting (picking and shelling) or for spoilage-free storage (except in the form of husked ears in a narrow crib; see Chapter 7). Small farmers usually let the maize stand in the field unharvested for several weeks or more to allow some further drying. In some areas, particularly Latin America, it is a common practice to bend the ears (or the plants and the ears) downward to prevent rain from entering through the ear tips and causing spoilage. It also helps minimize bird damage and lets in sunlight for any intercropped plants that may be seeded at this time.

Number of ears per plant: Most tropical and sub-tropical maize varieties commonly produce two to three useful ears per plant under good conditions. In contrast, most U.S. corn belt types are single eared. One advantage of multiple-eared varieties (often called prolifics) is that they have some built in buffering capacity in case of adverse conditions and may still be able to produce at least one ear.

Grain Sorghum (*Sorghum bicolor*)

Distribution and Importance

Although grain sorghum accounted for only 3.6 percent of total world cereal production in 1977 (FAO data), several factors make it an especially important crop in the developing world:

- The developing nations account for about 60 percent of the world's grain sorghum production.
- It is drought-resistant and heat-tolerant and particularly suited to the marginal rainfall areas of the semiarid tropics (such as the savanna and Sahel zones of Africa where food shortages have been critical).

Types of Sorghums

Grain Sorghum vs. Forage

Sorghum: Where sorghum is grown in the developed world, a definite distinction is made between forage sorghum and grain sorghum types. For example, in the U.S. (where grain sorghum is often called "milo"), nearly all grain types have had dwarf genes bred into them to reduce plant height to 90-150 cm for more manageable machine harvesting. In contrast, forage sorghum types are much taller and have smaller seeds and a higher ratio of stalk and leaves to grain. They are used largely for cattle feed as fresh green chopped forage or silage (green forage preserved by a fermentation process), but are sometimes grazed. Sudangrass is a variety of forage sorghum with especially small seedheads and thin-bladed leaves, and sorghum-sudan crosses also are available.

A grain sorghum plant nearing maturity

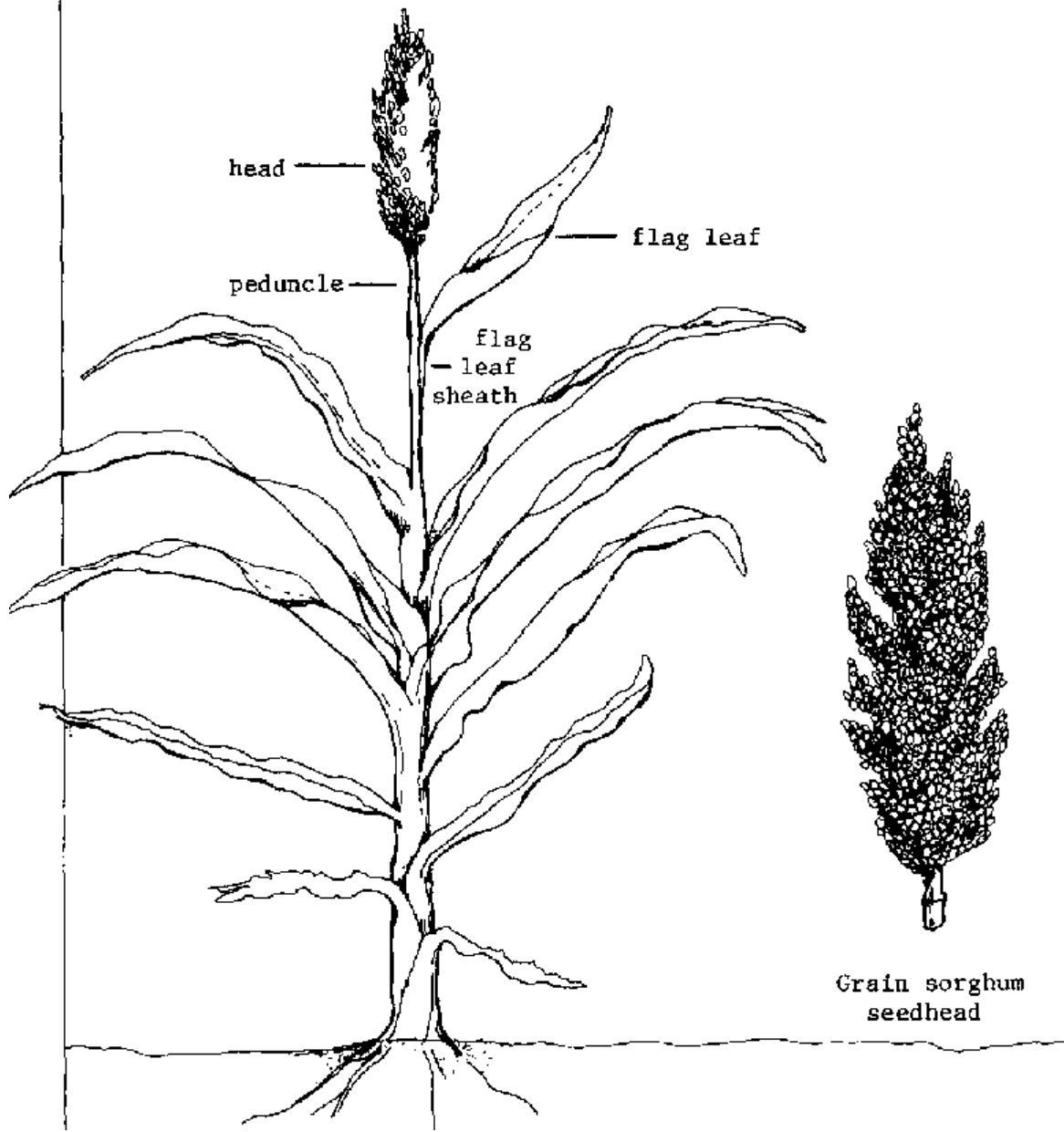

In the developing countries, especially where cattle are important, most traditional grain sorghum varieties have some forage type characteristics such as tallness and a high proportion of stalk to leaves.

Yields of Dry Grain

	Lbs./Acre	Kg/Hectare
Top yields in the U.S. under irrigation	9000-12,000	10,000-13,4000
Top rainfed yields in the U.S.	5000-8000	5600-9000
U.S. Average	3130	3520
Average for the developed countries	2900	3260
Average for developing countries	400-800	450-900

Feasible rainfed yields for farmers using improved practices	3360-5000	3000-4500
--------------------------------------------------------------	-----------	-----------

There are many regional variations among local grain sorghum types:

Sweet Sorghum (Sorgo) and Broomcorn: Sorgo types have tall, juicy stalks with a high sugar content and are used for making syrup and also for animal feed in the form of silage and forage. Broomcorn is a sorghum type grown for its brush, which is used mainly for brooms.

Sorghum Yields

Grain sorghum exhibits greater yield stability over a wider range of cropping conditions than maize. Although it will outyield maize during below-normal rainfall periods, the crop might suffer some damage under very high rainfall. Yields of dry (14 percent moisture) grain are shown under varying growing conditions (based on FAO, USDA, and international research institute data).

Protein content vs. yield: The protein content of sorghum kernels can vary considerably (7-13 percent on soils low in nitrogen) due to rainfall differences. Since nitrogen (N) is an important constituent of protein, kernel protein content is likely to be highest under very low rainfall that cuts back yields and concentrates the limited amount of N in a smaller amount of grain. Protein fluctuation is much less on soils with adequate nitrogen.

Climatic Requirements of Sorghum

Grain sorghum tolerates a wide range of climatic and soil conditions.

Rainfall: The sorghum plant, aside from being more heat- and drought-resistant than maize, also withstands periodic waterlogging without too much damage.

The most extensive areas of grain sorghum cultivation are found where annual rainfall is about 450-1,000 mm, although these higher rainfall areas favor the development of fungal seed head molds that attack the exposed sorghum kernels. The more open-headed grain sorghum varieties are less susceptible to head mold.

Several factors account for the relatively good drought tolerance of grain sorghum:

- Under drought conditions the plants become dormant and will curl up their leaves to reduce water losses due to transpiration (the loss of water through the leaf pores into the air).
- The leaves have a waxy coating that further helps to reduce transpiration.
- The plants have a low water requirement per unit of dry weight produced and have a very extensive root system.

Temperature and Soil Requirements: Although sorghum withstands high temperatures well, there are varieties grown at high elevations that have a good tolerance to cool weather as well. Light frosts may kill the above-ground portion of any sorghum variety, but the plants have the ability to sprout (ratoon) from the crown.

Sorghum tends to tolerate very acid soils (down to pH 5.0 or slightly below) better than maize, yet it is also more resistant to salinity (usually confined to soils with pH's over 8.0).

Response to Daylength (Photosensitivity)

Most traditional sorghum varieties in the developing countries are very photosensitive. In these photosensitive types, flowering is stimulated by a certain critical minimal daylength and will not occur until this has been reached, usually at or near the end of the rainy season. This delayed flowering enables the kernels to develop and mature during drier weather while relying on stored soil moisture. (This is actually

a survival feature which allows seed heads to escape fungal growth in humid' rainy conditions.) These local photosensitive varieties usually will not yield as well outside their home areas (especially further north or south) since their heading dates still remain correlated to the rainy season and daylength patterns of their original environment. Despite this apparent adaptation to their own areas, the traditional photosensitive varieties have a relatively low yield potential and may occupy land for a longer period to produce a good yield (due to their fixed flowering dates). In addition there is always the danger that the rains will end early and leave an inadequate reserve of soil moisture for kernel development. Breeding programs are attempting to improve these photosensitive types, and many of the improved varieties show little sensitivity to daylength.

DANGER The Toxicity Factor: Hydrocyanic Acid

Young sorghum plants or drought-stunted ones under 60 cm tall contain toxic amounts of hydrocyanic acid (HCN or prussic acid). If cattle, sheep or goats are fed on such plants, fatal poisoning may result. Fresh, green forage, silage, and fodder (dried stalks and leaves) are usually safe if over 90-120 cm tall and if growth has not been interrupted. The HCN content of sorghum plants decreases as they grow older and is never a problem with the mature seed. An intravenous injection of 2-3 grams of sodium nitrite in water, followed by 4-6 grams of sodium thiosulfate is the antidote for HCN poisoning in cattle; these dosages are reduced by half for sheep.

Other Sorghum Characteristics Ratooning and Tillering Ability

The sorghum plant is a perennial (capable of living more than two years). Most forage sorghums and many grain varieties can produce several cuttings of forage or grain from one planting if not killed by heavy frost or extended dry weather. New stalks sprout from the crown (this is called ratooning) after a harvest.

However, ratooning ability has little value in most areas where non-irrigated sorghum is grown. In these areas, either the rainy season or frost-free period is likely to be too short for more than one grain crop or too wet for a mid-rainy season first crop harvest without head mold problems. However, forage sorghums take good advantage of ratooning, since they are harvested well before maturity, usually at the early heading stage. Cattle farmers in El Salvador take three cuttings of forage sorghum for silage-making during the six-month wet season. In irrigated tropical zones with a year-round growing season such as Hawaii, it is possible to harvest three grain crops a year from one sorghum planting by using varieties with good ratooning ability.

Some grain sorghum varieties have the ability to produce side shoots that grow grain heads at about the same time as the main stalk (this is called tillering). This enables such varieties to at least partially make up for too thin a stand of plants by producing extra grain heads.

Nutritional Value and Uses of Sorghum

Nearly all grain sorghum used in the developed world is fed to lives (mainly poultry and swine). However, in developing countries it is an important staple food grain and is served boiled or steamed in the form of gruel, porridge, or bread. In many areas, it is also used to make a home-brewed beer. In addition, the stalks and leaves are often fed to lives and used as fuel and fencing or building material.

Like the other cereals, grain sorghum is relatively low in protein (8-13 percent) and is more important as an energy source. If eaten along with pulses in the proper amount (usually a 1:2 grain:pulse ratio), it will provide adequate protein quantity and quality. Only those varieties with a yellow endosperm (the starchy main portion of the kernel surrounding the germ) contain vitamin A.

Because sorghum is very susceptible to bird damage during kernel development and maturity, bird-resistant varieties have been developed. Because it has a high tannin content in the seeds, stalks, and leaves, it is partly effective in repelling birds from the maturing seedheads. However, these high tannin varieties are more deficient in the essential amino acid lysine than ordinary varieties which has

consequences for humans and other monogastrics like pigs and chickens. In the U.S., this is overcome by adding synthetic lysine to poultry and swine rations that are made from bird-resistant sorghum grains. In developing countries a slight increase in pulse intake can overcome this problem in humans.

Grain Sorghum Growth Stages

Depending on variety and growing temperatures, nonphotosensitive grain sorghum reaches physiologic maturity in 90-130 days within the 0-1000 m zone in the tropics. However, the local, daylength-sensitive varieties may take up to 200 days or more because of delayed flowering. At very high elevations, all varieties may take 200 days or more.

As with maize, the main difference between a 90-day and 130-day sorghum variety is in length of vegetative period (the period from seedling emergence to flowering). The grain filling period (pollination to maturity) is about the same for both (30-50 days). The following sections describe the growth stages and management factors of a typical 95-day variety. These principles remain the same no matter what variety is grown.

PHASE I: FROM EMERGENCE TO THREE WEEKS

Sorghum seedlings will emerge in three to six days in warm, moist soil. Under cool conditions where emergence is delayed, the seeds are especially prone to harmful soil fungi and insects, and a fungicide/insecticide seed dressing may be particularly beneficial (see Chapter 6). Compared to maize, the small sorghum seeds are low in food reserves which are quickly exhausted before enough leaf area is developed for photosynthesis. For this reason the seedlings get off to a slow start during the first three weeks, after which the growth rate speeds up.

This sluggish beginning makes good weed control extra important during this time.

For the first 30 days or so, the growing point which produces the leaves and seedhead is below the soil surface. Hail or light frost is unlikely to kill the plant, since new growth can be regenerated by the growing point. However, regrowth at this stage is not as rapid as with maize.

PHASE II FROM THREE WEEKS TO HALF-BLOOM (60 days after emergence)

Growth rate and the intake of nutrients and water accelerates rapidly after the first three weeks. The "flag" leaf (the final leaf produced) becomes visible in the leaf whorl about 40 days after emergence. "Boot" stage is reached at about 50 days when the flower head begins to emerge from the leaf whorl but is still encased by the flag leaf's sheath. The head's potential size in terms of seed number has by now been determined. Severe moisture shortage at boot stage can prevent the head from emerging completely from the flag leaf sheath. This will prevent complete pollination at flowering time.

Half-bloom stage is reached at about 60 days when about half of the plants in a field are in some phase of flowering at their heads. However, an individual sorghum plant flowers from the tip of the head downward over four to nine days, so half-bloom on a per plant basis occurs when flowering has proceeded halfway down the head. Although time to half-bloom varies with variety and climate, it usually encompasses two-thirds of the period from seedling emergence to physiologic maturity. In keeping with the rapid rates of growth and nutrient intake, about 70, 60, and 80 percent of the nitrogen, phosphorus, and potassium requirements (respectively) have been absorbed by the plant by the time of half-bloom. Severe moisture shortage at pollination greatly cuts yields by causing seed ovule abortion and incomplete pollination.

PHASE III: FROM HALF-BLOOM TO PHYSIOLOGIC MATURITY (60-95 days)

The seeds reach the soft dough stage about 10 days after pollination (70 days after emergence) in a 95-day variety, and about half of the final dry weight yield is accumulated during this short period. Hard dough stage is reached in another 15 days (85 days after emergence) when about three-fourths of the final dry weight grain yield has been attained. Severe moisture stress during this period will produce light,

undersized grain. Physiologic maturity is reached in another 10 days (95 days from emergence in the case of this variety.) At this stage, the grain still contains 25-30 percent moisture which is well above the 13-14 percent safe limit for storage in threshed form (after the seeds have been removed from the head). Small scale farmers can cut the heads at this stage and dry them in the sun before threshing or let the heads dry naturally on the plants in the field.

The Millets

TYPES OF MILLET

The millets comprise a group of small-seeded annual grasses grown for grain and forage. Although of little importance in the developed world, they are the main staple food grain crop in some regions of Africa and Asia and are associated with semi-arid conditions, high temperatures, and sandy soils. Of the six major millet types listed below, pearl millet is the most widely grown and will receive the most emphasis in this manual.

Millets - How a sorghum plant develops

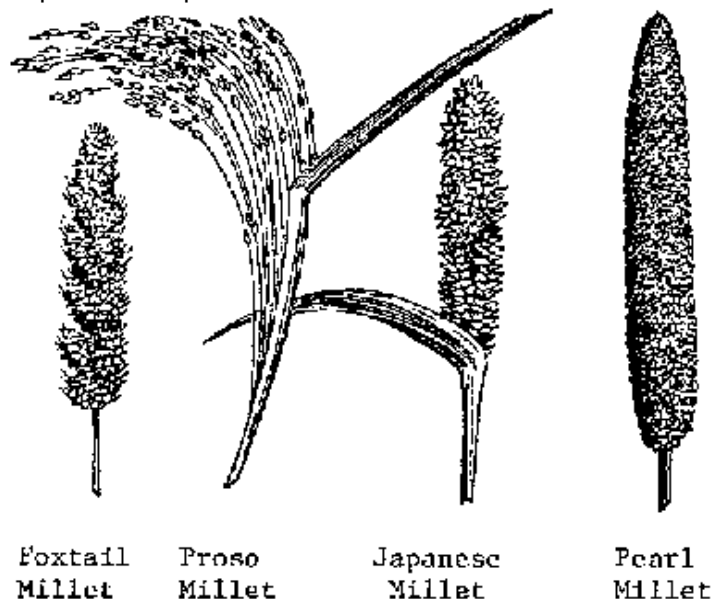

Pearl Millet

Other Names: Bulrush, cattail, and spiked millet, bajra, millet, milt

Scientific Name: Pennisetum typhoides, P. glaucum or P. americanum

Main Areas of Production: Semi-arid plains of southern Asia (especially India) and the Sahel (sub-Saharan) region of Africa.

Important Characteristics: The most drought- and heat-tolerant of the millets; more prone to bird damage than finger millet.

Finger Millet

Other Names: Birdsfoot millet, eleusine, ragi

Scientific Name: Eleusine coracana

Main Areas of Production: The southern Sudan, northern Uganda, southern India, the foothills of Malaysia and Sri Lanka

Important Characteristics: Unlike other millets, it needs cool weather and higher rainfall; higher in protein than the others.

Proso Millet

Other Names: Common, French, and hog millet, panicum, miliaceum

Scientific Name: Panicum miliaceum

Main Area of Production: Central Asia, USSR

Important Characteristics: Used mainly as a short-duration emergency crop or irrigated crop.

Teff Millet

Scientific Name: *Eragrostis abyssinica*

Main Area of Production: Mainly the Ethiopian and East African highlands up to 2700 m where it is an important staple food.

Japanese or Barnyard Millet

Other Names: Sanwa or shame millet

Scientific Name: *Echinochloa crusgalli*, *E. frumentacea*

Main Areas of Production: India, East Asia, parts of Africa; also in the Eastern U.S. as a forage

Important Characteristics: Wide adaptation in terms of soils and moisture; takes longer to mature (three to four months total) than the others.

Foxtail Millet

Scientific Name: *Setaria italica*

Main Area of Production: Near East, mainland China

Important Characteristics: Very drought-resistant.

Millet Yields

Average millet yields in West Africa range from about 300-700 kg/ ha. They tend to be low due to marginal growing conditions and the relative lack of information concerning improved practice. Compared to maize, sorghum, and peanuts, research efforts with millet have only yielded 1000-1500 kg/ha and improved varieties have produced up to 2000-3500 kg/ha.

Climatic Requirements of Millet

Rainfall: Pearl millet is the most important cereal grain of the northern savanna and Sahel region of Africa. It is more drought resistant than sorghum and can be grown as far north as the 200-250 mm rainfall belt in the Sahel where varieties of 55-65 days maturity are grown to take advantage of the short rainy season. Although pearl millet uses water more efficiently and yields more than other cereals (including sorghum) under high temperatures, marginal rainfall, sub-optimum soil fertility, and a short rainy season, it does lack sorghum's tolerance to flooding.

Soil: Pearl millet withstands soil salinity and alkaline conditions fairly well. (For more information on salinity and alkalinity problems, refer to Peace Corps, Soils, Crops, and Fertilizer Manual, 1980 edition.) It is also less susceptible than sorghum to boring insects and weeds, but shares sorghum's susceptibility to losses from bird feeding, which damages the maturing crop.

Nutritional Value and Uses of Millet

Pearl, foxtail, and proso millets all contain about 12 to 14 percent protein which is somewhat higher than most other cereals. The most common method of preparing pearl millet in West Africa is as "kus-kus" or "to", a thick paste made by mixing millet flour with boiling water. Millet is used also to make beer. The stalks and leaves are an important livestock forage and also serve as fuel, fencing, and building material.

Traditional Pearl Millet Growing Practices in West Africa

The traditional West African pearl millet varieties are generally 2.5-4.0 m tall with thick stems and a poor harvest index. They are usually planted in clumps about a meter or so apart, very often in combination with one to three of the other reference crops, usually sorghum, cowpeas, and groundnuts. Many seeds are sown per clump, followed by a laborious thinning of the seedlings about two to three weeks later. The tiny millet seeds are low in food reserves which become exhausted before the seedlings can produce enough leaf area for efficient photosynthesis and enough roots for good nutrient intake. Therefore, as

with sorghum, the growth rate is very slow for the first few weeks. Two general classes of pearl millet are traditionally grown in West Africa:

- The Gero class whose varieties are 1.5-3.0 m tall, early maturing (75-100 days), and neutral or only slightly photosensitive in daylength response. In some parts of the savanna, these short-season Geros mature at the peak of the wet season, but have good resistance to the fungal seedhead molds and insects favored by the rains. The Geros make up about 80 percent of the region's millet and are preferred for their higher yields and shorter maturity over the Maiwa class. They mature in July-August in the Guinea savanna and August-September in the Sudan savanna.
- The Maiwa class is taller (35 m), later maturing (120 - 280 days), and much more photosensitive in daylength response than the Gero group. As with the photosensitive sorghum varieties, the Maiwas will not flower until at or near the end of the rains, which allows them to escape serious head mold and insect damage. However, they yield less than the Geros and account for only about 20 percent of the region's millet. In the higher rainfall portions of the savanna 500-600 mm per year where both millet and sorghum can be grown, farmers usually prefer to plant photosensitive sorghum varieties. These have about the same length of growing period, but yield more than the Maiwas due to a longer grain-filling period. However, the Maiwas are favored over the sorghums on sandier soils with lower water storage ability. Some farmers will also choose the Maiwas over the sorghums because the former mature slightly sooner, thus spreading out the harvest labor demands for these late season crops. (The Maiwas are harvested a month or so into the dry season.)

Many of the traditional millets produce abundant tillers (side shoots produced from the plant's crown). However, this tillering is non-synchronous, that is, tillering development lags behind that of the main stem. As a result, these secondary shoots mature later than the main stem. If soil moisture remains adequate, two or more smaller harvests can be taken.

Aside from the normal rainfed millet production, the crop is also planted on flood plains or along river borders as the waters begin to recede. This system is referred to as recessional agriculture and also may involve sorghum.

Peanuts (*Arachis hypogea*)

DISTRIBUTION AND IMPORTANCE

Peanuts are an important cash and staple food crop in much of the developing world, particularly in West Africa and the drier regions of India and Latin America. The developing nations account for some 80 percent of total world production, with two-thirds of this concentrated in the semi-arid tropics. Because of repeated droughts, disease problems, and other factors, Africa's share of the world peanut export market declined from 88 percent in 1968 to 43 percent in 1977, while its share of total production fell from 36 percent to 26 percent during the same period.

Types of Peanuts

There are two broad groups of peanuts:

- Virginia group: Plants are either of the spreading type with runners or of the bunch (bush) type. Their branches emerge alternately along the stem rather than in opposed pairs. The Virginia varieties take longer to mature (120-140 days in the tropics) than the Spanish-Valencia types and are moderately resistant to Cercospora leaf-spot, a fungal disease that can cause high losses in wet weather unless controlled with fungicides (see Chapter 7). The seeds remain dormant (do not sprout) for as long as 200 days after development, which helps prevent premature sprouting if they are kept too long in the ground before harvest.
- Spanish-Valencia group: Plants are of the erect bunch type and non-spreading (no runners). Their branches emerge sequentially (in opposed pairs), and their leaves are lighter green. They have a shorter growing period (90-110 days in warm weather), are highly susceptible to Cercospora leafspot,

and have little or no seed dormancy. Pre-harvest sprouting can sometimes be a problem under very wet conditions or delayed harvest. They are generally higher yielding than the Virginia variety if leaf spot is controlled.

Plant breeders have made some promising crosses between these two groups.

Peanut Yields

Average peanut yields in the developing countries range from about 500-900 kg/ha of unselled nuts, compared with the U.S. average of 2700 kg/ha, based on 1977 FAO data. Farmers participating in yield contests have produced over 6000 kg/ha under irrigation, and yields of 4000-5000 kg/ha are common on experiment station plots throughout the world. Feasible yields for small farmers who use a suitable combination of improved practices are in the range of 1700-3000 kg/ha, depending on rainfall.

Peanut plant

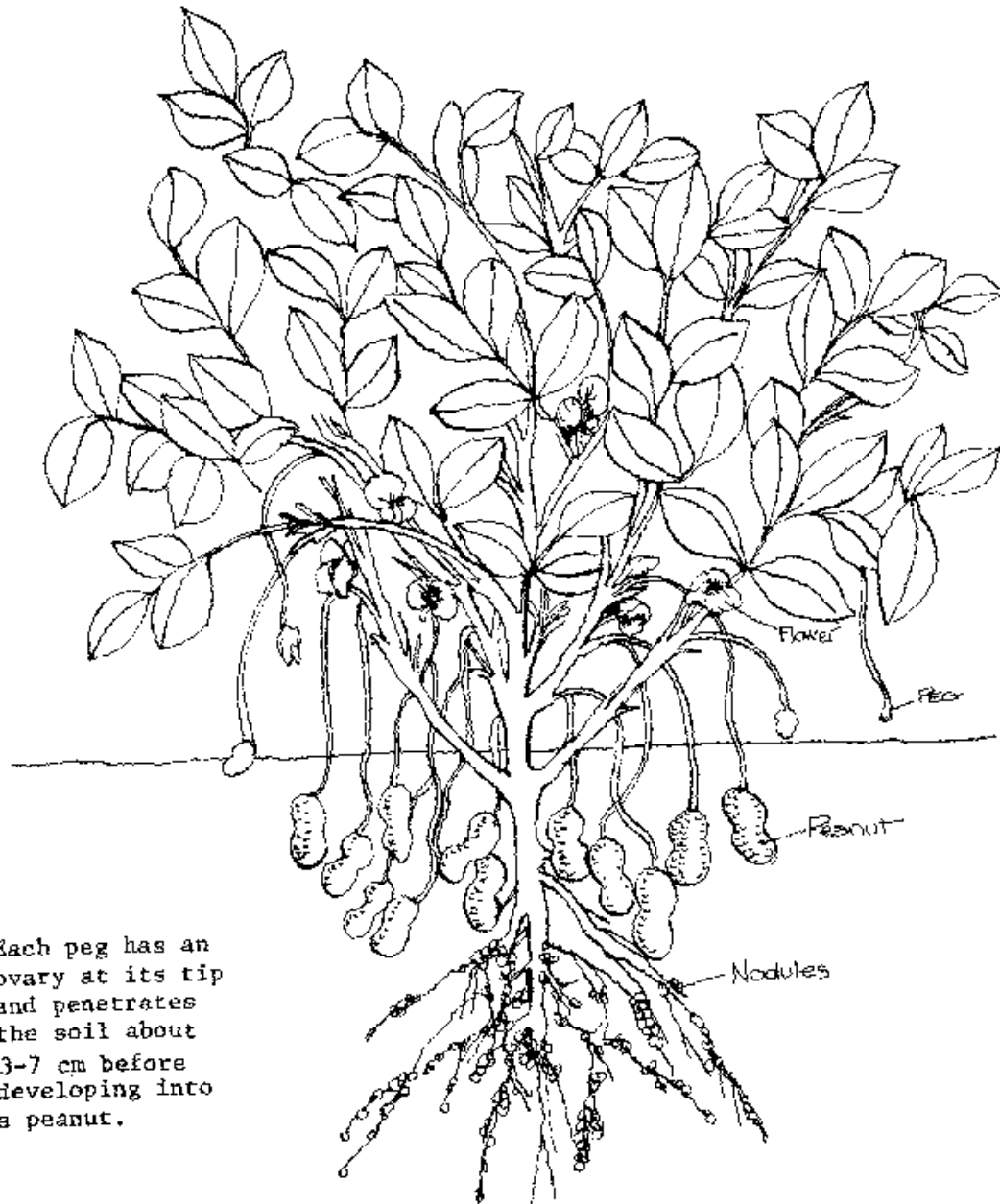

Each peg has an ovary at its tip and penetrates the soil about 3-7 cm before developing into a peanut.

Each peg has an ovary at its tip and penetrates the soil about 3-7 cm before developing into a peanut.

Climatic and Soil Adaption of Peanuts

Rainfall: Peanuts have good drought resistance and heat tolerance. They mature in 90-120 days in warm weather, which makes them especially well suited to the short wet season of the northern savanna zone of West Africa. They can be grown in moister climates if diseases (especially leafspot) can be controlled and if planted so that harvest does not coincide with wet weather.

Temperature: During the vegetative (leaf development) phase temperature has little effect on yields. However, the rate of flowering and pollen viability are greatly influenced by temperatures during flowering (about 35-50 days after emergence). Pod production is adversely affected by temperatures below 24°C or above 33°C. At 38°C, for example, flowering is profuse, but few pods are produced.

Soils: Peanuts do not tolerate water-logging, so good soil drainage is important. Soils that crust or cake are unsuitable, since penetration of the pegs is unhindered.

Clayey soils can produce good results if well drained, but harvest (digging) losses may be high due to nut detachment if the plants are "lifted" when such soils are dry and hard. On the other hand, harvesting the crop on wet, clayey soils may stain the pods and make them unsuitable for the roasting trade.

Peanuts grow well in acid soils down to about pH 4.8, but do have an unusually high calcium requirement which is usually met by applying gypsum (calcium sulfate). Peanut fertilizer requirements are covered in Chapter 5.

Nutritional Value and Uses of Peanuts

The mature, shelled nuts contain about 28-32 percent protein and vary from 38-47 percent oil in Virginia types to 47-50 percent oil in Spanish types. They are also a good source of B Vitamins and Vitamin E. Although lower in the essential amino acid lysine (a determinant of protein quality) than the other pulses, peanuts are a valuable source of protein.

In the developing nations peanuts are consumed raw, roasted or boiled or used in stews and sauces. The oil is used for cooking and the hulls for fuel, mulching, and improving clayey garden soils.

Commercially, the whole nuts are used for roasting or for peanut butter. Alternatively, the oil is extracted using an expeller (pressing) or solvent method and the remaining peanut meal or cake (about 45 percent protein) is used in poultry and swine rations. Peanut oil is the world's second most popular vegetable oil (after soybean oil) and can also be used to make margarine, soap, and lubricants. The hulls have value as hardboard and building-block components.

Plant Characteristics of Peanuts

Peanuts are legumes and can satisfy all or nearly all of their nitrogen needs through their symbiotic relationship with a species of Rhizobia bacteria. A characteristic of the peanut plant is that the peanuts themselves develop and mature underground.

Peanut Stages of Growth

Depending on variety, peanuts take anywhere from 90-110 days to 120-140 days to mature. The peanut plant will flower about 30-45 days after emergence and will continue flowering for another 30-40 days. The peanuts will then mature about 60 days after flowering.

PHASE I EMERGENCE

Within a day or so after planting in warm, moist soils, the radicle (initial root) emerges and may reach 10-15 cm in length within four to five days. About four to seven days after planting, two cotyledons break the soil surface where they will remain while the stem, branches, and leaves begin to form above them. The plants grow slowly in the early stages and are easily overtaken by weeds.

PHASE II - FLOWERING TO POLLINATION

Flowering begins at a very slow rate about 30-45 days after plant emergence and is completed within another 30-40 days. The flowers are self-pollinated, but bees and rain improve fertilization (and therefore kernel production) by "triggering" the flowers and aiding in pollen release. The flowers wither just five to six hours after opening. A plant may produce up to 1000 flowers, but only about one out of five to seven actually produces a mature fruit.

PHASE III - PEG EMERGENCE TO MATURITY

The pegs (stalk-like structures, each containing a future fruit at its tip) begin elongating from the withered flowers about three weeks after pollination and start to penetrate the soil. After the pegs penetrate to a depth of about 2-7 cm, the fruits begin to develop rapidly within about 10 days and reach maturity about 60 days after flowering. Those pegs that form 15 cm or more above the ground seldom reach the soil and abort.

It is important to note that the fruits do not all mature at the same time, since flowering occurs over a long period. An individual fruit is mature when the seed coats of the kernels are not longer wrinkled and the veins on the inside of the shell have turned dark brown. Harvesting cannot be delayed until all the fruits have matured or heavy losses will result from pod detachment from the pegs and from premature sprouting (Spanish-Valencia types only). Choice of harvesting date is an important factor in obtaining good yields.

Traditional Peanut Growing Practices

Small farmers in some developing countries, especially in West Africa, often plant peanuts together with one or more other crops such as sorghum, millet, cowpeas, cotton, and vegetables. Whether intercropped or sown alone, peanuts are usually planted on ridges (raised up mounds or beds) about one meter apart; this improves soil drainage and facilitates digging. In the northern savanna areas of West Africa, they are generally planted in June and harvested in September or October. In the southern, higher rainfall sections of the savanna, it is often possible to grow two crops (April or May until August for the first, and August or September to November or December for the second). Most of the local varieties, especially in the more humid areas, are of the Virginia type which has much better leaf-spot resistance.

Common Beans And Cowpeas

Importance and Distribution

Along with peanuts, this group makes up the bulk of the edible pulses grown in tropical and subtropical developing nations. Aside from their importance as a protein source, the crops play an important role in the farming systems of these areas:

- They are especially well suited to climates with alternating wet and dry seasons.
- Being legumes, they are partly to wholly self-sufficient in meeting their nitrogen requirements.
- They are the natural partners of the cereals in intercropping and crop rotations (see Chapter 4).

According to FAO estimates for the 1975-77 period, world dry bean production was about 12.4 million tons annually. Latin America accounts for about a third of world production and produces mainly common (kidney) beans which are also the major type grown in East Africa. Cowpeas are the major grain legume (peanuts excluded) of the West Africa savanna zone.

This section deals with common beans and cowpeas (dry beans). In the appendices are similar descriptions of other pulses such as pigeonpeas, chickpeas, lima beans, mung beans, soybeans, and winged beans.

Common (Kidney) Beans (*Phaseolus vulgaris*)

Other Names: Field beans, frijoles, haricot beans, string beans (immature stage), snap beans (immature stage).

Bean plant and pod

The flowers
develop into
pods after
pollination.



Part of a bean plant
with flowers.



A bean pod.

Types

Bean varieties can be classified according to three basic characteristics - seed color, growth habit, and length of growing period:

1. Seed Color: Most are black or red seeded, and there are usually distinct local preferences regarding color.
2. Growth Habit: Varieties can be erect bush, semi-vining or vining types; the latter have a vigorous climbing ability and require staking or a companion support crop like maize. Bush varieties flower over a short period with no further stem and leaf production afterwards; these are called determinate. The vining types flower over a longer period and continue leaf and stem production; these are called indeterminate. Semi-vining varieties can be of either type. Given their longer flowering period, most indeterminates have uneven pod maturity with the harvest period stretched out over a number of weeks.
3. Growth Period: In warm weather, early varieties can produce mature pods in about 70 days from plant emergence, while medium and late varieties take 90 days or more. Time to first flowering ranges between 30 and 55 days. With some exceptions, the erect bushy types reach maturity earlier than the vining indeterminate types. Plant breeders are developing indeterminate varieties with shorter growing periods and more compact maturity.

Climatic Requirements of Beans

Rainfall: Common beans are not well suited to very high rainfall areas (such as the humid rainforest zones of tropical Africa) because of increased disease and insect problems. Ideally, planting should be timed so that the latter stages of growth and harvest occur during reasonably dry weather.

Temperature: Compared to sorghum and millet, beans do not tolerate extreme heat or moisture stress well. Few varieties are adapted to daily mean temperatures (average of daily high and low) over 28 C or

below 14 C. Optimum temperatures for flowering and pod set is a daytime high of 29.5°C and a nighttime low of 21 C. Blossom drop becomes serious over 36 C and is aggravated also by heavy downpours.

Soil: The plants are very susceptible to fungal root rot diseases, and good drainage is very important. They usually grow poorly in acid soils much below pH 5.6, since they are especially sensitive to the high levels of soluble manganese and aluminum which often occur at the lower pH levels.

Daylength: Unlike some sorghums and millets, most beans types show little response to daylength variations.

Nutritional Value and Uses of Beans

Common beans contain about 22 percent protein on a dry seed basis. They provide adequate protein quality and quantity for older children and adults if eaten in the proper proportion with cereals (about a 2:1 grain:pulse ratio. In the green bean form, they provide little protein, but are a good source of Vitamin A. The leaves can be eaten like spinach and also are used as lives forage.

Cowpeas (*Vigna sinensis*, *V. unguiculata*, *V. sesquipedalia*)

Other Names: Black-eyed peas, southern peas, crowder peas.

Types

Cowpeas have much the same variations in seed color, growth habit, and length of growing period as common beans except that cowpea seeds are usually brown or white. There are three separate species:

- Vigna Sinensis: the common cowpea in Africa and most of Latin America. The large, white seeded types are preferred in most of West Africa.
- Vigna unguiculata: catjung cowpea, a primitive type found mainly in Asia, but also in Africa.
- Vigna sesquipedalia: the asparagus or yardlong bean widely grown in Asia mainly for its immature pods.

Most traditional varieties tend to be late maturing (up to five months' and vining Improved bush (little or no vining) types are available and capable of producing good yields in 80-90 days.

Growing Practices and Yields of Cowpeas

Traditional practices and yield constraints of cowpeas are similar to those of common beans. Average yields in the developing countries run from 400-700 kg/ha of dry seed, compared to a California (U.S.) average of about 2200 kg/ha under irrigation. Field trial yields in Africa and Latin America are largely in the 1500-2000 kg/ha range with some over 3000 kg/ha.

CLIMATIC REQUIREMENTS OF COWPEAS

Rainfall: Cowpeas are the major grain legume (peanuts excluded) of the West African savanna (zone). However, they also are grown in many other regions. They have better heat and drought tolerance than common beans, but the dry seed does not store as well and is very susceptible to attacks by weevils (see Chapter 7).

Temperature:

High daytime temperatures have little effect on vegetative growth but will reduce yields if they occur after flowering. High temperatures at this time can cause the leaves to senesce (die off) more quickly, shortening the length of the podfilling period. High temperatures will also increase the amount of blossom drop. As with common beans and most crops, humid, rainy weather increases disease and insect

problems. Dry weather is needed during the final stages of growth and harvest to minimize pod rots and other diseases.

Soil: Cowpeas grow well on a wide variety of soils (if they are well drained) and are more tolerant of soil acidity than common beans.

Nutritional Value and Uses of Cowpeas

The dry seeds contain about 22-24 percent protein. The immature seeds and green pods also are eaten. They are considerably lower in protein than the mature seeds, but are an excellent source of Vitamin A while green, as are the young shoots and leaves. The plants are a good live forage and are sometimes grown as a green manure and cover crop (see Chapter 5).

Increasing reference crop production

There are basically four ways of increasing the production of the reference crops:

- Improving existing cropland
- Extending cultivation to new, uncropped areas
- Improving the infrastructure
- Establishing crop improvement programs.

Any meaningful production increase will require varying emphasis on all four methods.

Improving Existing Cropland

Unquestionably, improved drainage (by land leveling, runoff canals or underground tile drains) and erosion control are high-gain investments. Erosion control not only reduces soil losses and yield deterioration, but in many cases actually improves production by increasing the amount of rainfall retained by the soil.

In the case of irrigation projects, however, the results are often mixed. Many irrigation projects have paid little attention to the potential environmental damage or to the technical problems and soil types involved. Huge dams and artificial lakes have definite appeal on paper, but have often led to drainage and salt accumulation problems, as well as to weed-choked canals and serious health hazards like malaria and schistosomiasis (bilharzia).

Pumping projects relying on wells face similar problems and can seriously lower the water table to the point of endangering the supply. Water alone is not enough to assure profitable yields which must be high to cover the added costs of irrigation. Unless such projects are carefully planned and combined with a crop improvement program, the results are likely to be disappointing.

Extending Cultivation To New Areas

The FAO estimates that total world food production increased by about 50 percent from 1963-76, while cultivated land area grew by only two percent. Estimates concerning the amount of additional cultivable land differ considerably, but suggest that the world as a whole is utilizing only about one-third to one-half of actual and potential arable land (suitable for crops or for lives). The largest areas of "new" land are in the lowland tropics of Latin America, Africa, and Southeast Asia. There are, however some drawbacks:

- Only a small percentage of these lands are capable of sustaining intensive agriculture because of soil or climate factors; an alarming proportion has been claimed by land speculators or is being divided up into ranches by investors, as in Brazil.
- Whether in high rainfall or in arid regions, much of this land is prone to accelerated erosion or irrigation-induced salinization (accumulation of salts at the soil surface).

- As we have seen, most of the reference crops are not well adapted to high rainfall and humidity. Pasture and perennial crops may be the best choices under these constraints.

Improving the Infrastructure

In agriculture, the infrastructure refers to those installations, facilities, inputs, and services that encourage production. The most important of these are:

- Roads and transport
- Markets and marketing standards
- Storage facilities
- Improvements to land such as drainage, erosion control, and irrigation
- Yield-increasing technology
- A viable extension service
- Availability of agricultural machinery and equipment
- Political stability
- Credit
- An equitable land tenure and distribution system
- National planning for agricultural development
- Crop prices that encourage increased output

The small farmers in most areas of the developing world do not enjoy the same access that larger farmers do to these essential factors of production. Agricultural public works projects such as irrigation, flood control, and farm-to-market roads are usually undertaken according to pure economic feasibility or in response to special interest groups. Larger farmers in a number of developing countries, especially in Latin America, are often organized into producer's associations with very effective lobbying powers.

Inequities in land tenure and distribution can have tremendous social and economic consequences and can effectively dampen farming incentives for those affected. In El Salvador, 19 percent of the farms occupy about 48 percent of the land and belong to wealthy "latifundistas" (ranch-type farmers) who grow cotton, coffee, and sugarcane, frequently on an absentee basis. These farms are concentrated on the country's best soil, while the "campesinos" (small farmers) are restricted to the eroded and rocky hillsides where they grow maize, sorghum, and beans. About 47 percent of the country's farms are smaller than 2.47 acres (one hectare) and occupy only four percent of the total land. The majority of the farm units in El Salvador, Guatemala, and Peru have been designated as sub-family.

While the implementation of most other infrastructural essentials is hindered mainly by insufficient capital, land reform faces heavy political obstacles and in some cases is not feasible in terms of land supplies. Furthermore, when small farmers purchase land in densely populated regions like the Guatemala Highlands, the Cibao area of the Dominican Republic, and the lake region of Bolivia, competition frequently drives land prices too high for farming to be economical.

Crop Improvement Programs

More than any other single factor, the development of yield-improving technology associated with the crop improvement programs of the national and international research institutes will play the mayor role in increasing the yields of the reference crops in the developing countries.

Reference crop improvement programs

The term "crop improvement" is a broad one and refers to any attempt to improve crop yields, quality, palatability or other characteristics through plant breeding or the development of improved growing, harvest, and storage practices. The most successful efforts are well-organized, multidisciplinary (involving several relevant skill areas such as entomology and soil fertility), and crop-specific and aim at developing a "package" of improved practices centered around high-yielding, adapted varieties.

A large number of yield-determining factors and crop characteristics can be at least partially manipulated or controlled by plant breeding and improved production practices' as shown in the table on the next page.

Farming Practices Affecting Crop Yields and/or Quality

- Method of land preparation (type of tillage and seedbed)
- Fertilizer use (kind, amount, timing, placement)
- Variety selection Plant density and spacing
- Water management (soil drainage, erosion control, moisture conservation practices)
- Control of weeds, insects, diseases, nematodes, and birds by chemical or nonchemical methods
Adjustment of soil pH
- Control of soil compaction due to equipment or animals
- Cropping system (monoculture versus intercropping; crop rotation)
- Harvesting, drying, and storage methods

Non-manipulative factors:

In contrast to the production factors listed above there are a number of others largely beyond the control of both the farmer and the crop improvement worker. These include such variables as the weather and certain soil characteristics (i.e. texture, depth, filth).

Crop improvement programs for individual crops

Maize

Potential for Improvement

Of all the reference crops, maize has the highest yield potential in terms of grain production per unit of land area under conditions of adequate moisture and improved practices. Maize is generally less troubled by insects and diseases than the pulses, especially beans and cowpeas. In addition, more breeding work has been done with maize than any other major food crop.

Success of control attained by plant breeding and improved crop production

Control Attained						
	Good	Fair to Good	Fair	Poor to Fair	Poor to Good	Poor
Crops in General	Harvest index (ratio of stalk and leaves to grain) Plant architecture (height, leaf size, leaf weight, etc.)	General plant vigor and yield ability Length of growing period Fertilizer response Plant density tolerance		Resistance to insects Resistance to nematodes Resistance to heat and cold Tolerance to low or high pH Tolerance to low phosphorous	Resistance to diseases Resistance to droughts Nutritional value Palatability & cooking quality	

The Reference Crops Maize		Husk covering Resistance to tipping over Ears/plant				
Sorghum/ Millet		Photosensitivity Tillering Vitamin A (sorghum)	Ratooning ability Bird resistance (sorghum)	Resistance to striga weed Resistance to head mold (sorghum)		Resistance to birds (millet)
Peanuts		Resistance to leaf spot Seed dormancy		Resistance to nematodes Susceptibility to aflatoxin		
Beans and Cowpeas	Growth habit (vining or bush)	Seedcoat color			Resistance to disease and insects	

Current Research Activities and Crop Programs

The International Maize and Wheat Improvement Center (CIMMYT)* in Mexico is the institute most involved in maize improvement and acts as the caretaker and shipping agent for the world's most complete collection of maize germplasm (plant genetic material). It cooperates extensively with the International Institute for Tropical Agriculture (IITA) in Nigeria and The International Center for Tropical Agriculture in Columbia (CIAT) in their respective maize programs as well as with national improvement programs throughout the developing world. In 1979, CIMMYT sponsored international maize variety trials in 84 countries at 626 sites to compare its varieties with those from local and other foreign sources.

* See "Reference", for international institute addresses

The CIMMYT-developed varieties originate from a well-organized breeding program. During the 1970s the center developed 34 germ plasm pools (genetic groups) classified according to three climate types (tropical lowland, tropical highland, and temperate), four grain types (flint, dent, white, yellow), and three lengths of maturity (early, medium, late). Advanced lines are developed from these pools by selecting for yield, uniformity, height, maturity, and resistance to diseases, insects, and lodging (tipping over). They are then grown at a number of locations in Mexico. The most promising are used in preliminary international trials, and the best of these become experimental varieties for more extensive trial work overseas.

Spreading Improvement Practices for Maize

From 1961-77, total maize production in the developing countries rose by 66 percent, while acreage increased by 33 percent and yields by 24 percent. However, on an individual country basis, only about half the developing countries have made significant gains (1979 CIMMYT Annual Report). The bulk of adaptive research work with maize in the developing countries has occurred in certain areas of Latin America. Africa and Asia, however, have location-specific growing problems in terms of soils, climate, insects, and diseases for which varieties and improved practices still must be developed. The CIMMYT is presently cooperating with national maize programs in Tanzania, Zaire, Ghana, Egypt and Pakistan as well as Guatemala and is providing staff support to most of them. In addition, it cooperates on a regional basis with Central America and the Caribbean, South and Southeast Asia (11 countries), and the Andean zone (Bolivia, Colombia, Ecuador, Peru, and Venezuela all grain importing countries).

Disease and insect resistance is a top priority at CIMMYT. This organization has a cooperative breeding program with six national maize programs (Thailand, the Philippines, Tanzania, Zaire, Nicaragua, and El

Salvador) to develop resistance to downy mildew (important in Asia and spreading to other regions), maize streak virus (Africa), and corn stunt virus (tropical Latin America).

Maize Production Achievements

The Puebla Project in Mexico was the first large-scale attempt to improve small-farmer maize production.

Under CIMMYT administration, the project involved 47,000 farm families in a highland region of Puebla State. Average farm size in the project area was 2.7 ha, operating mainly under dryland (non-irrigated) conditions. Several "packages" of improved practices were developed to suit varying climatic and soil conditions in the zone, and adequate support and delivery systems were sought for the needed inputs, including agricultural credit. By 1972, maize production had increased in the project area by some 30 percent and average family income had increased by 24 percent in real terms. Rural employment was also favorably affected due to an increase in labor needed for every hectare of maize.

The Puebla Project was innovative in moving the "Green Revolution" (the first organized attempt to develop yield improving practices for staple food crops in developing countries) off the experiment station and into the field and in concentrating on dryland rather than irrigated farming.

Similar examples exist in many other developing countries. Experimental plots frequently yield over 6000 kg/ha and it is generally agreed that 3000 kg/ha or more is a reasonable yield goal for small farmers in most regions. Since the real test of an improved variety is its performance under actual farm conditions, CIMMYT is encouraging the cooperating countries to run extensive trials on farmers' fields rather than confining them to the experiment station where conditions are often unrealistically ideal. On the Horizon: Scientists have been working on breeding a nitrogen-fixing ability similar to that of legumes into maize. By 1985, they hope to have experimental varieties capable of satisfying up to 10 percent of their nitrogen requirements.

Grain Sorghum

Potential for Improvement

Yields of grain sorghum are generally not as spectacular as those of maize, since the crop is often grown under less than ideal conditions. Sorghum's advantage over maize is its much better yield stability over a wider range of climatic conditions, especially under high temperature and low rainfall. Many of the traditional varieties in the semi-arid tropics are overly tall, are photosensitive, and have an excessive ratio of stalk and leaves to grain. Their delayed flowering enables them to escape serious grain head mold problems and insect damage, but often there is too little soil moisture for grain development which takes place at the start of the dry season. These factors, along with poor management and the large plants' intolerance to healthy plant densities (populations), account for low yields averaging around 600-900 kg/ha in the semi-arid tropics.

Current Research Activities and Crop Programs

The International Crops Research Institute for the Semiarid Tropics (ICRISAT), located in Andhra Pradesh, India, is the major international institute engaged in sorghum improvement. Some of its major goals include the development of varieties with little or no photosensitivity. These varieties would have a shorter growing season and be better adapted for drier areas or shallow soils with low water holding capacity. They would be planted later, but flower about two weeks earlier than traditional types and therefore need good head mold resistance for maturing under more humid conditions. Plant height would be about 2.0-2.5 meters with a better ratio of grain to stalk and leaves. Since sorghum plants are an important lives forage in much of the semiarid tropics dwarf varieties like those used in the U.S. would not be acceptable. The new varieties would mature in 90-120 days.

Also under consideration are plants with heavy tillering ability to allow compensation for low plant populations and a variety with resistance to striga (a serious parasitic weed, see Chapter 6), sorghum midge, sorghum shoot fly (see Chapter 6) and drought. Work is also being done to develop more

coldtolerant varieties for highland or cool-season tropical conditions, and plants with improved disease resistance, especially to downy mildew, charcoal rot, smuts, anthracnose, and rust 'see Chapter 6). Finally, the institute hopes to develop a hi-lysine and higher protein sorghum that has better cooking quality and palatability.

Spreading Improvement Practices for Sorghum

In the southern savanna region of West Africa, improved photosensitive varieties have yielded over 3500 kg/ha in 120-140 days, some two months less than local varieties. They can be sown later in the wet season and will flower about 8-14 days earlier than the local types, thus assuring better moisture availability for grain filling.

As of yet, highly photoinensitive (day neutral) varieties with good head mold resistance have not been developed. There are improved types of this class that are available with 90-120 day maturities, but their planting must be scheduled late enough in the wet season so that the grain fill period occurs at the start of the dry season to avoid head mold. This, however, subjects them to probable moisture stress

Improvements in sorghum protein: In 1974 two lines of sorghum with 30 percent more protein and double the lysine of conventional types were discovered in Ethiopia. However, these lines suffer from some of the same drawbacks as hi-lysine maize in that the grain has a soft starch, floury endosperm (the major portion of the seed surrounding the germ Embryol) that is very susceptible to storage insects and to breakage under grain threshing using animal trampling. Also, studies have shown these extra protein benefits to vary greatly under different environmental conditions. For example, low soil nitrogen content can cause both the lysine and protein percentage to drop to normal levels. It may be 1985 or later before such improved nutrition varieties are released.

Nitrogen-fixing ability: As with maize, attempts to breed some nitrogen-fixing ability into sorghum are only in the early experimental stages.

Production improvements and the future: Sorghum lags behind maize in successful on-farm yield improvement campaigns. Most successes have occurred in the less marginal rainfall areas. For example, although high-yielding sorghum varieties were released in India in the mid-60's, they spread little beyond regions with assured rainfall or irrigation. A major factor is the highly variable climatic environment of the semi-arid tropics where standardized technology packages have only limited suitability, thus requiring greater adaptive research efforts. However, organized efforts at sorghum improvement are much more recent than those for maize, and the future does look promising.

Millet

Potential for Improvement

Millet yields are generally lower than those of sorghum due to harsher growing conditions and a shorter period of grain filling. Traditional West African varieties have major limiting factors such as poor plant architecture. They tend to be overly tall and have a poor harvest index.) In addition, the photosensitive types often flower too late in the season, causing moisture stress during grain filling. Those varieties which are not as affected by daylength (the Geros) have moderate tillering ability, but it is not synchronous with the main stem. Thus, most of the tillers flower too late, when moisture is not adequate for grain filling.

Current Research Activities and Crop Problems

The ICRISAT breeding program concentrates mostly on pearl millet, and it aims at improved drought, insect, and disease resistance, increased response to improved practices, better harvest index, and varieties with a range of maturities to suit varying rainfall patterns. It is selecting also for varieties particularly suited to intercropping combinations. Protein content and early seedling vigor are other concerns.

In West Africa and the Sudan ICRISAT has a program to develop high-yielding sorghum and millet varieties. This cooperative program includes the countries of Mali, Upper Volta, Niger, Ghana, Chad, The Gambia, Senegal, Nigeria, Mauritania, Cameroon, and Benin.

Achievements in Millet Improvement

As with sorghum, millet improvement efforts in the developing countries are relatively recent and at an early stage. The ICRISAT trials in West Africa during 1976 and 1977 showed that new varieties were not much better than the existing West African types with a few exceptions. The major problem was lack of disease resistance and overly early maturity. On the other hand, breeding efforts in Senegal have produced high-yielding dwarf types capable of better fertilizer response. These have an improved harvest index and a maturity range of 75-100 days. Some of the best ICRISAT varieties have yielded up to 4000 kg/ha in international trials. Progress also is being made in the development of varieties with good resistance to downy mildew (*Sclerospora graminicola*), a serious fungus disease encouraged by high humidity. As with maize and sorghum, attempts are being made to develop some limited nitrogen-fixing ability in millet, but results are at least four to five years away.

On the Horizon: Millet production should expand significantly in the future as more marginal rainfall land is brought under cultivation. Further research is expected to make the millets one of the most productive cereals on a yield per area per time basis (yield of crop in a certain area per cropping cycle per year).

Peanuts

Potential for Improvement

When grown under ideal moisture conditions, peanut and other pulse crop yields are about one-third to one-half those of maize. However, since peanuts are about three times higher in protein than maize, the yields are actually very similar on a protein per area basis (a 2000 kg/ha peanut crop produces about the same total amount of protein as a 6000 kg/ha maize crop). This is also the case with the other pulses, all of which have two to three times more protein than the cereals. In short, the pulses are geared more to producing modest yields of high protein seed rather than high yields of starchy seed as with the cereals. Although the lower yields of the pulses should be kept in mind, there is potential for yield improvement in the developing countries where production per hectare lags considerably behind that of the developed countries.

Research Activities and Crop Improvement

Since peanuts are self-pollinated, the development of new varieties by crossing is difficult and time-consuming. The individual flowers must be manually emasculated and then hand pollinated. Since seed production per plant is comparatively low, multiplication of improved types is very slow, although they can be propagated by cuttings.

Most efforts concentrate on collecting and improving local and introduced varieties by selecting for adaptability, drought resistance, oil and protein content, disease and insect resistance, and shelling percentage (ratio of shell weight to kernel weight).

Spreading Peanut Improvement Activities

The major international institute involved with peanut improvement in the developing countries is ICRISAT. Advanced work is also being done in several of the developed countries such as the U.S. (especially Georgia, North Carolina, and Texas), Australia, and South Africa, but it is designed to serve their local conditions. Other centers of peanut improvement are Senegal, Nigeria, the Sudan, Mexico, Argentina, and Brazil.

Breeding for earliness to suit short rainy seasons, seed dormancy (to prevent in-ground sprouting), and resistance to rust, leafspot, and aflatoxin (see Chapter 6) are all being conducted by ICRISAT. Work in

Senegal has developed several lines resistant to rosette virus, a serious problem in the wetter peanut zones of Africa.

Of the reference crops, peanuts are the most complicated in terms of growing and harvesting practices needed for good yields. Seed bed preparation, weed and disease control, and harvesting require particular attention to detail and timeliness. Being a much higher value crop than the cereals, repeated applications of foliar fungicides for leaf spot control have a good cost-benefit ratio and are another example of the relative sophistication required for good yields. Undoubtedly, plant breeding has a role to play in peanut improvement, but improved management practices are particularly important for boosting yields.

In those developing countries where peanuts are a major export crop, marketing is usually controlled by a government board, which also provides storage facilities and may act as a supplier of seed, fertilizer and other inputs. Under these conditions, adaptive research work is also given greater priority, but the weak link is also the extension system, which must bridge the gap between the farmer and the experiment station. In general, yields are far below the 1700-300 kg/ha range that is feasible under improved practices where moisture stress is not serious.

Beans and Cowpeas

Until the early 1970s, pulse improvement had been largely neglected. Compared to the cereals, these grain legumes seemed to offer less promising opportunities due to their relatively low yields and greater susceptibility to insects and diseases. However, in view of their high protein contents and potential as nutritional complements to the cereals, research and extension programs can no longer afford to ignore them. The best yields of the cereals and the pulses are fairly similar when compared on a protein produced per area basis.

Common Beans Potential for Improvement

Early research seemed to suggest that common beans were one of the least productive of the pulses. However, a comparative growth study by the International Center for Tropical Agriculture (CIAT) in 1978 involving five grain legumes showed that common beans and cowpeas were the two most efficient on a yield per day of growth basis (the other three involved were pigeon-peas, soybeans, and mung beans).

Unfortunately, current average yield for Africa and Latin America are a low 600 kg/ha, while CIAT has obtained up to 4300 kg/ha under monocropping (beans as the sole crop) and 3000 kg/ha in mixed plantings with maize.

Current Research Activities and Crop Programs

The major international institute involved in common bean improvement is CIAT. In 1973 they established a Bean Production Systems Program to increase the production and consumption of the crop in Latin America. In addition it also cooperates with developing countries in other areas. This effort is now being supplemented by a recently organized U.S. government-sponsored program for cooperative dry bean research between U.S. universities and developing countries.

The CIAT program aims to increase bean yields through several methods:

- Development of improved varieties resistant to major diseases and several stress factors like low soil phosphorus, soil acidity, drought, and temperature extremes. Special attention is being given to mixed cropping with maize.
- Breeding for improved nitrogen fixation. Currently, common beans are one of the more inefficient nitrogen fixers and require moderate rates of supplemental fertilizer.
- Developing improved management practices for both monoculture and mixed cropping systems (see chapter 4).

- Training personnel from national programs in other developing countries and developing a strong bean research network in Latin America and East Africa.

As part of its international trials program, CIAT maintains an International Bean Yield and Adaptation Nursery (IBYAN), consisting of 100 entries. This IBYAN is replicated by CIAT and shipped to many other countries to be used in their experimental work with beans. The Center for Tropical Agriculture, Research, and Training (CATIE) in Turrialba, Costa Rica also is involved in bean improvement work.

Spreading Bean Improvement Practices

After nearly some five years of breeding work, most of the improved varieties CIAT sent out for international trials in 1979 carried some resistance to major pest problems like common mosaic virus, rust, common bacterial blight, angular leaf spot, anthracnose, and a damaging species of leafhopper (Empoasca Kraemeri) prevalent in Latin America. Strains were found also that showed some tolerance to low levels of soil phosphorus and to aluminum and manganese toxicity which often affects bean in highly acidic soil (much below pH 5.5). Both CIAT and CATIE have made significant progress in improving bean-maize multiple cropping systems through improved management and bean variety development.

Due to the relatively recent interest in bean research, on-farm yield improvement programs have made nowhere near the impressive and widespread gains of maize, rice, and wheat. However, research achievements in breeding and management are at the point where farmers can increase their yields with a well-organized extension program.

Cowpeas

Progress in Cowpea Improvement

The International Institute for Tropical Agriculture (IITA) in Nigeria is the mayor international institute involved in cowpea improvement and is working toward good pest resistance, improved yields, and the development of a package of improved practices for cowpeas under multiple cropping conditions common in tropical Africa. By 1978, IITA had released a total of five new strains (VITA 1-5) with better yield and pest resistance and a good protein content. They are capable of producing 1500-2500 kg/ha under small-farmer improved management, compared to the current West African average of around 500 kg/ha. The creamy white seed color of VITA 5 is favored in much of Africa. As with common beans, on-farm yield improvement extension efforts are still in their early stages.

4. Planning and preparation

This chapter deals with reference crop production fundamentals and current recommendations concerning cropping systems, land preparation, seed selection, and planting. The production fundamentals section describes the how, what, and why of these farm operations. The compendium section provides a current summary of reference crop production recommendations based largely on information from international research institutes and some national extension services. Although the compendium section does offer general suggestions for the various crops, agriculture is a location-specific endeavor. This section is mainly designed to show how recommendations vary according to differences in each area's physical environment and specific infrastructure.

Cropping systems

As explained earlier, the term "cropping system" refers both to a farmer's or region's overall cropping pattern, and to the specific crop sequences and associations involved, namely:

1. Monoculture: The repetitive growing of a single crop on the same field year after year.

2. Crop Rotation: The repetitive growing of an orderly succession of crops (or crops alternating with fallow) on the same field.

3. Multiple Cropping:

a. Sequential cropping: Growing two or more crops in succession on the same field per year or per growing season, sometimes referred to as double or triple cropping. Example: Planting maize in May, harvesting it in August, and then planting beans. Only one crop occupies the field at a time.

b. Intercropping: This is the most common definition of multiple cropping and involves growing two or more crops at the same time on the same field. There are four basic variations:

- Mixed intercropping: Two or more crops without a distinct row arrangement.
- Row intercropping: Same as mixed intercropping but with a distinct row arrangement.
- Relay intercropping: Growing two or more crops simultaneously during part of the life cycle of each. The second crop is usually sown after the first has reached its reproductive stage (i.e., around flowering time) but before it is ready to harvest. Example: Planting a climbing bean variety alongside maize that has recently tasseled.
- Strip intercropping: Growing two or more crops in separate strips wide enough for independent cultivation, but narrow enough to react agronomically.

Monoculture vs. Crop Rotation

It is difficult to compare the pros and cons of monoculture versus crop rotation since much depends on the crops, soils, management practices, climate and economics involved. Monoculture is frequently blamed for soil "exhaustion" (erosion problems and declining fertility and filth) and a buildup of insects and diseases, yet this is not always the case. Some very productive areas of the U.S. Corn Belt have over 50 percent of their cropland devoted to continuous maize, which yields as well as that grown under crop rotation. In fact, Corn Belt research has shown that continuous maize grown under that region's conditions results in a less serious insect buildup than when maize is grown in a crop rotation with soybeans or pasture and hay. On the other hand, monoculture cotton in the southern U.S. in the 19th and early 20th centuries led to serious soil degradation and insect problems.

Monoculture is uncommon under small farmer conditions in developing countries, since intercropping is prevalent and a variety of crops must be produced for subsistence needs. It is mainly confined to perennial cash and export crops such as coffee, sugarcane, citrus, and bananas. Whether or not monoculture is harmful depends on the type of crop and soil management and climate factors.

Type of crop:

- Row crops which provide relatively little ground cover or return only small amounts of residues (stems, leaves, branches and other debris left in the field after harvest) to the soil are poorly suited to monoculture (i.e. cotton, peanuts, maize or sorghum grown for fodder or silage).
- Some crops like beans, potatoes, and many vegetables are especially prone to insects and soil-borne diseases which usually build up under monoculture.

Soil Management and Climate Factors: A soil's physical condition (filth and permeability), natural fertility, and nutrient-holding ability are directly related to its organic matter (humus)* content.

*Humus is organic matter that has been fairly well decomposed.

- Row crop monoculture will seriously lower soil humus levels unless all crop residues are returned to the soil along with supplemental additions of manure in sizeable amounts (around 30 metric tons/ha or more per year).
- The tillage and cultivation operations associated with mechanized (or animal traction) row crop production aerate the soil, which accelerates the microbial breakdown and loss of humus. That is part of the reason why many farmers in the U.S. and Europe have switched to minimum tillage systems such as plowing and planting in one operation. Minimum tillage leads to problems with weeding and herbicidal use.
- The problem of humus loss is especially serious in the tropics due to higher temperatures. Decomposition takes place three times as fast at 32°C than at 15.5°C.
- Erosion problems associated with row crops are more serious in the tropics due to higher intensity rainfall (even in semi-arid areas).

Crop rotation may or may not be beneficial in terms of soil condition, insects, and diseases. In terms of soil condition, the ideal would be to rotate low-residue crops like cotton and vegetables with medium-residue crops like corn, sorghum and rice or, better yet, with pasture, but few small farmers can afford this type of flexibility. Including a nitrogen-fixing legume crop like peanuts or beans in the rotation will not necessarily boost the soil's nitrogen content significantly, since much of the nitrogen produced ends up in the harvested seeds themselves. Some areas have experimented with green manure (legume) crops like cowpeas, which are plowed under around flowering time to add humus and nitrogen to the soil (no harvest is taken), but there are several problems with this approach:

- Few farmers are willing to tie up their land growing a non-harvested crop.
- The effect of green manure crops on soils is short-lived under tropical conditions.
- The green manure crop may use up soil moisture needed by the next crop.

Suggested Crop Rotation for the Reference Crops

The variables are too great to make specific recommendations of wide applicability. Much depends on the area's soils, climate, prevalence and type of intercropping, and common insects and diseases.

Some general recommendations can be made:

- Crops which share similar diseases (especially soil-borne ones like root rots) should not be grown on the same field within three years of each other. For example, peanuts, tobacco, beans, soybeans, and sweet potatoes are all susceptible to Southern Stem Blight (Sclerotium rolfsii), as well as to the same types of nematodes, and should not be grown on the same field in succession.
- A crop like peanuts or beans which is especially susceptible to soil-borne diseases should not be grown on the same field more than one year out of three. Again, intercropping may lessen these problems, but not always.
- Monoculture is less of a problem if disease-resistant varieties are available and are being continually developed in response to new disease strains.

Intercropping (Multiple Cropping)

Intercropping combinations involving two or more of the reference crops (sometimes along with others) are very common on small farms in the developing world.

Intercropping is not ordinarily suited to mechanized farming, but strip intercropping is sometimes used when multiple-row machinery can be operated.

The Pros and Cons of Intercropping

Pros

- Less risk since yields do not depend on one crop alone.
- Better distribution of labor.
- Some diseases and insects appear to spread less rapidly under intercropping.
- Better erosion control due to better ground cover.
- Any legumes involved may add some nitrogen to the soil.

Cons

- Mechanization is difficult.
- Management requirements are higher.
- Overall costs per unit of production may be higher due to reduced efficiency in planting, weeding and harvesting.

The type of multiple cropping is closely related to rainfall and length of rainy season as shown below:

Annual Rainfall	Prevalent Type of Multiple Cropping
300-600 mm	Simultaneous mixed intercropping with crops of similar maturities
600-1000 mm	Crop mixes of different maturities
Over 1000 mm	Three types of multiple cropping: sequential, simultaneous, and relay

Advances in Intercropping Systems

Multiple cropping is a diverse and complex subject whose guidelines are often very location-specific. Research interest in multiple cropping has increased markedly over the past decade with most attention being focused on cereal-legume combinations which appear to have the greatest potential, particularly maize or sorghum with beans or cowpeas. The following research results are presented not to imply their direct applicability to a given area but to provide ideas of the many factors involved in intercropping and the state of the art of these complex systems.

The National Maize Program in Zaire has been looking into maize rotations and intercropping with legumes to improve soil fertility without commercial fertilizer. Rotations using soybeans and Crotalaria (a green manure crop poisonous to lives) have been tried. So far, Crotalaria looks superior in nitrogen-fixing ability with the succeeding maize crop, yielding up to 9000 kg/ha. Maize following a soybean green manure crop has yielded up to 6700 kg/ha. The National Maize Program has also worked with an intercrop combination of cowpeas and maize, but has not yet found suitable cowpea varieties.

Both rotations and intercropping of maize with legumes appear to offer some promise in Zaire, but there are two main problems:

- Legume seeds are harder to store from one year to the next under humid conditions.
- Even though legumes used as green manures may contribute a good deal of soil nitrogen, farmers are still likely to need fertilizer, since legumes will not do well on the low-phosphorus soils prevalent throughout much of the tropics.

Pearl millet-peanut intercropping trials by the International Crop Research Institute for the Semi-Arid Tropics (ICRISAT) in India showed yield advantages of up to 25-30 percent. An arrangement of one row millet to three rows peanuts appeared to provide the optimum balance of competition.

Maize-Bean Intercropping Research:

The International Center for Tropical Agriculture (CIAT) has run numerous maize-bean intercropping trails at various locations in Colombia. The trials involve simultaneous or near-simultaneous planting of the two crops rather than relay planting. Results were as follows:

- For the farmer, the optimum ratio of maize plants to bean plants depends not only on the relative yields but also on the maize-bean price ratio which ranges from 1:2 up to 1:7 in some Latin American countries.
- A large number of trials involving simultaneous or near-simultaneous plantings of maize with beans showed that bush bean yields were decreased by about 30 percent and climbing bean yields about 50 percent compared to when grown alone.
- Maize yields were usually not adversely affected by the association with beans at a maize population of 40,000 plants/ha. Maize plant densities over 40,000/ha decreased bush bean yields by shading, while densities below 40,000/ ha lowered climbing bean yields because of inadequate support.
- At 40,000 maize plants/ha, relative yields of the two crops were best at bush bean densities of 200-250,000 plants/ha and at climbing bean densities of 100-150,000 plants/ha.
- Yields of climbing beans were highest when they were planted simultaneously with maize; bush bean yields were highest when the beans were planted one to two weeks before maize, although this caused a significant yield decrease in the maize. Results varied with temperature and the relative early vigor of the bean and maize seedlings.

In a 1976 Center for Tropical Agriculture, Research and Training (CATIE) trial in Costa Rica, intercropped populations of 50,000/ha for maize and 200,000/ha for bush beans were found to be the best combination and produced yields of 3400 kg/ha and 1800 kg/ha respectively.

A 1976 study in the Minas Gerais area of Brazil by the Universidade Federal de Vicosa focused on relay intercropping of maize and beans. Maize populations of 20-, 40-and 80,000 per hectare were intercropped with climbing beans at 100-, 200-, 300- and 400,000 plants/ha. The maize was planted in the wet season, and the beans were planted between the maize rows when the maize was nearing maturity. The following results were obtained:

- Maize yield was not affected by the beans and was highest at 60,000 plants/ha.
- Bean yields were highest at the lowest maize population and were not affected by bean plant density.
- Even though the beans were planted as the maize was starting to dry out, the maize still exerted a strong competitive effect, mainly due to shading. When grown alone under trellising, the bean variety normally yielded 1200-2000 kg/ha at a density of 250,000/ha, but yielded 800 kg/ha when grown with a maize population of 20,000/ha.

Cowpeas-Millet-Sorghum: Experience in Africa has shown that cowpea yields are reduced about 45-55 percent when intercropped with millet and sorghum. However, when grown alone, the improved cowpea varieties become more prone to serious insect attack and often require chemical pest control. Furthermore, intercropped cowpeas are not usually sown until later in the wet season and are viewed more as a bonus crop which does not reduce the millet and sorghum yields.

Improving Traditional Multiple Cropping Systems

In southeast Guatemala, small farmers usually plant maize, sorghum, and beans by hand on steep to rolling rocky land, and yields average around 530, 630 and 410 kg/ha respectively. Due to a severe labor shortage for planting at the start of the season, the farmers plant the beans in dry soil. They then overplant the maize and sorghum once the rains arrive without regard to where the yetto germinate beans are. With the local varieties used, if the beans emerge first, they will dominate the maize and sorghum; the reverse will happen if the maize and sorghum germinate first. Hoping for a balanced harvest, the farmers are in a race against time to finish planting the maize and sorghum before the beans germinate. The main disadvantage of this traditional system is the risk that the dry-planted beans may receive only

enough rainfall to germinate without sufficient additional precipitation to sustain growth (i.e., a wet season "false start").

Researchers have experimented with several alternatives. The most promising one involves strip intercropping of maize, sorghum, beans and cowpeas.

At the start of the wet season, beans are planted in strips consisting of three rows spaced 30cm apart. Sufficient space is left between these strips to accommodate sets of double (twin) maize rows with two "varas" (164.0 cm) between the centers of the twin rows. Two or more of these twin row sets of maize can be planted between bean strips depending on the desired cropping mixture. The 30 cm bean row spacing is unusually narrow but gives better weed control due to earlier inter-row shading. Also, the strips are narrow enough to be hand-weeded from the sides to avoid soil compaction or trampling the plants.

Once the beans emerge, the maize rows are planted. If the rains stop for a while after bean planting, maize sowing can be delayed without danger of the beans dominating the young maize seedlings (one advantage of strip intercropping). The beans are a short season variety that matures in 60-65 days.

As soon as the beans are harvested, a short season sorghum variety is planted in the space between the sets of twin maize rows. Later, the nearly mature maize plants are doubled over to reduce any shading of the young sorghum plants, which are slow starters. This points the ear tips downward, preventing water entry (which favors fungal grain rots) and reducing bird damage.

About two weeks before the maize is doubled, cowpeas are sown along the outer edges of the twin maize rows (i.e., along the edges of the harvested bean strips). The leaves of the maize plants are stripped off as they die off with maturity and used as a mulch (soil covering) to conserve soil moisture. The cowpeas use the maize stalks to climb on and cause no competition due to their late planting.

Shifting Cultivation As a Cropping System

Shifting cultivation (slash and burn agriculture) is a traditional cropping system that was once widely practiced throughout the humid tropics. Due to increasing population pressure on land, the system is now mainly confined to the dense forest areas of the Amazon Basin, Central and West Africa, and Southeast Asia.

While there are some variations, shifting cultivation consists of three major steps:

1. The land is incompletely cleared by hand cutting and burning trees and other vegetation. The burning has several effects:

- All the vegetation's nitrogen and sulfur is lost to the atmosphere as gasses. However, the other nutrients (phosphorus, potassium, calcium, etc.) are deposited on the ground as ash.
- Even though much organic matter is lost, a lot has already been added to the soil over the years by leaf fall and root decomposition.
- Burning only kills some insects, diseases, and weed seeds, not all of them.

2. Crops are grown on the land for two or three years, usually under some form of intercropping that may include long-cycle crops such as manioc (cassava) and yams in humid regions. Little, if any, tillage (hoeing, etc.) is required for seedbed preparation, since the soil is usually in good physical condition as a result of the previous fallow. The crops utilize the naturally accumulated nutrients from the fallow period. Yields are fair the first year, but then rapidly decline, causing the land to be temporarily abandoned after several years of cropping.

3. The land is then allowed to revert to a natural vegetation fallow for 5-10 years in order to "rejuvenate" the soil in several ways:

- The vegetation, especially if it consists largely of trees and other deep-rooted species, recycles leachable nutrients like nitrogen and sulfur that may be carried into the soil by rainfall during the cropping and fallow periods. Some of the fallow vegetation may be leguminous and actually add nitrogen to the soil.
- The fallow increases the amount of soil humus which is a vital storehouse and source of nutrients, as well as being a great improver of soil physical condition.
- Small, but significant, amounts of nitrogen are produced by lightning, and these are added to the soil by associated rainfall.

The fallow period also helps avoid a buildup of pests and diseases. Shifting cultivation requires no outside inputs and is in complete harmony with the natural environment of the humid tropics. However, the system's success depends heavily on maintaining an adequate length of fallow cycle. As the frequency of clearing and burning increases, trees and brush are eventually killed off and give way to a very inferior grass (savanna) fallow, which is shallowrooted, inefficient at recycling and accumulating nutrients, and very difficult to clear off for cropping. (Many tropical grass species are actually stimulated into dense regrowth by burning.) Under these conditions, slash and burn agriculture becomes a menace to the environment, causing severe deforestation, erosion, and soil exhaustion. Many areas of Central America have been denuded in this manner.

Improving Shifting Cultivation:

As explained, the system is basically suited only to the humid tropical forest zones under low population density. European attempts to replace shifting cultivation in parts of Africa with "modern" agriculture usually met with disaster (erosion, pests, diseases, and a serious decline in soil condition). Some tropical soils have an iron-rich laterite layer which may become exposed through erosion. Unless such soils are kept under continuous shade, the laterite can harden irreversibly, making them useless.

Listed below are some of the most promising possibilities for improving shifting cultivation:

- The "Taungya" system of Burmese origin involving agriculture and forestry; it basically consists of clearing land for a cropping cycle followed by planting fastgrowing trees to provide lumber and rural improvement. Both phases would be operating simultaneously within an area.
- Using fertilizers (chemical or organic) to increase yields during the cropping period.
- Seeding the fallow area with specially selected plants that may be more beneficial than the natural species; the improved fallow might include dense growing vining legumes or leguminous trees and shrubs.

Land preparation for cropping

On small farms, land preparation methods for the reference crops may or may not involve actual tillage (working the soil with hoes, plows or other equipment) or seedbed shaping (leveling land or making raised beds or ridges).

Methods Involving No Tillage or Seedbed Shaping

Under conditions of shifting cultivation, low management or steeply sloping or rocky soils, land is often cleared by simply slashing and/or burning, followed by making the seed holes with a planting stick or hoe. No attempt is made to actually till the soil or to form a specific type of seedbed.

- Slash, burn and plant: This method is most suitable for sandy soils which are naturally loose or for other soils that are maintained in good tilth (a loose, crumbly condition) by a lengthy vegetative fallow

which produces soil humus. It may be the only feasible method for rocky soils or those with pronounced slopes where tillage would accelerate erosion.

- Slash, mulch and plant: This method is suited to the same conditions. The vegetation is slashed down or killed with a herbicide and then left on the surface to form a mulch (a protective covering). The seeds may be planted in the ground or may even be scattered over the ground before slashing. The mulch is valuable for erosion and weed control, conserving soil moisture, and keeping soil temperatures more uniform. The International Institute for Tropical Agriculture (IITA) has found this system very beneficial for maize and cowpeas and has developed two types of handoperated planters capable of planting seed through a mulch.

There is nothing basically wrong with either of these methods. However, in some cases, tillage and seedbed shaping may have some important advantages:

- Soils prone to drainage problems due to topography, soil conditions or high rainfall usually require the use of raised beds or ridges for successful crop production (except for rice).
- If liming is needed to correct excessive soil acidity, it must be mixed thoroughly into the top 15-20 cm of soil to be fully effective.
- Chemical fertilizers containing phosphorous and potassium and organic fertilizers should be incorporated several centimeters into the soil for maximum effectiveness. Under non-tillage methods, they can still be correctly applied using a hoe or machete, but it is definitely more work. Chemical fertilizers containing phosphorus are best applied to the reference crops in a band 7.5-10 cm deep that parallels the crop 5-6 cm to one side. A fertilizer furrow can be made easily with a wooden plow or other animaldrawn implement.
- Most animal- or tractor-drawn planters require a tilled seedbed for successful operation. There are exceptions, however, such as the IITA planters.

Methods Involving Tillage

Tillage refers to the use of animal- or tractor-drawn equipment or hand tools to work the soil in preparation for planting and has five main purposes:

- To break up and loosen the soil to favor seed germination, seedling emergence, and root growth
- To chop up and/or bury the previous crop's residues so they will not interfere with the new crop
- To control weeds (an ideal seedbed is completely weedfree at planting time)
- To incorporate (mix into the soil) liming materials and fertilizers (chemical or organic)
- To shape the kind of seedbed most suited to the particular soil, climate, and crop (i.e., raised beds, ridges, flat seedbeds).

Primary tillage refers to the initial breaking up of the soil by plowing or using a heavy-duty digging hoe. Depth of plowing usually ranges from about 15-30 cm, depending on the type of plow used, its traction source, and the soil. For example, an ox-drawn wooden plow will not have the penetration ability of a tractor-drawn moldboard plow, especially in heavy soils.

Secondary tillage refers to any additional tillage operations between plowing and planting to break up clods, cut up trash, kill weeds, and smooth out the seedbed. It is most commonly performed with some type of harrow (an implement used to pulverize and smooth the soil). Secondary tillage is shallower than planting and requires less power. Ridging and bedding (forming ridges or beds for raised planting) also can be included in this category.

Reference Crop Tillage Systems

The reference crops share the same basic tillage methods, but these vary with the particular soil, the available tillage equipment, and the need for incorporating lime or fertilizer. There are three basic tillage systems, each with advantages and disadvantages:

- Plow (or hoe)/Plant: If plowed at the right moisture level, some soils (especially loams and sands) may be suitable for sowing with a planter without any secondary tillage to break up the clods. Most soils can be hand-planted after plowing, since the farmer has better control over seed depth than when a mechanical planter is used. He can also push any big clods aside or break them up while walking down the row. This type of rough seedbed is actually very advantageous in terms of weed control since the cloddy surface discourages their growth. It also favors moisture penetration and reduces runoff. On the other hand, if bedding or ridging is needed, a better job can be done if any large clods are first broken up by harrowing (cultivating).
- Plow/Harrow/Plant: This is the most common system where animal- or tractor-drawn planters are used, unless the soil breaks up well enough under plowing alone. If soil conditions are conducive to weed growth, the ground should be harrowed as close to planting as possible to give the crop a head start on the weeds.
- Minimum Tillage: Farmers with access to tractor- or animal-drawn tillage equipment may overdo tillage, especially through repeated harrowings to control sprouting weeds or break up clods. Killing one crop of weeds by stirring the soil only stimulates another by moving other weed seeds closer to the soil surface. Excessive tillage stimulates the microbial breakdown of humus and may further destroy good soil physical condition by over-pulverizing the soil. The machinery, animal, and foot traffic also compact the soil, impairing root growth and drainage.

Tillage is seldom excessive when hand tools are used to prepare ground for the reference crops, because of the amount of labor it would involve. Slash-and-burn and slash-and-mulch methods fall under zero tillage, as do methods using specially adapted mechanical planters to sow seed into unplowed ground (common in the U.S.). The plow/plant system described above or plowing and planting in one tractor pass are examples of minimum tillage. The savings on equipment wear and fuel are advantages where tractors are used.

Tillage and Seedbed Fineness

The degree to which clods need to be broken up depends mainly on seed type and seed size and whether hand planting or mechanical planting will be used.

1. Seed type: Maize, millet and sorghum are monocots with seedlings that break through the soil with a spike-like tip. This reduces the need for a clod-free seedbed. Peanuts and other pulses are dicots, and emerge in a blunt form, dragging the two seed leaves with them; they tend to have more trouble with clods.
2. Seed size: Large seeds have more strength than small seeds, enabling young shoots to push more effectively through rough seedbeds. Maize seeds are large monocots, which gives them especially good clod handling ability. Peanuts and the other pulses are large-seeded, but this advantage is partly offset, since they are dicots. The small seeds of sorghum and especially millet are less powerful, but this is offset by the fact that they are monocots. Small seeds require shallower planting than larger ones, and cloddy soils do not allow this type of precision if mechanical planters are used.
3. Farmers can usually get by with cloddier seedbeds when hand planting. They have more control over planting depth and can push any large clods aside. In addition, it is very common under hand planting to sow several seeds per hole, which gives them a better chance of breating through.

Clayey soils, especially those low in humus, are usually in a cloddier condition after plowing than loamy or sandy ones. Most plowing takes place at the end of the dry season, when soils are very dry, which

accentuates the problem. Rainfall following plowing may significantly reduce clod problems on some soils by breaking up the clods.

Tillage Depth

A plowing depth in the 15-20 cm range is usually adequate, and there is seldom any advantage in going deeper. In fact, shallower plowing is often recommended for low rainfall areas like the Sahel to conserve moisture.

In some areas, tractor-drawn sub-soilers (long narrow shanks that penetrate down to 60 cm) are used in an attempt to break up deep hardpans (compacted layers). Results are fair to poor, depending on the type of hardpan; those consisting of a dense clay layer often re-cement themselves within a short time.

About 65-80 percent of the reference crops' roots are found in the topsoil, since this layer is more fertile (partly due to its higher organic matter content) and less compacted than the subsoil. However, any roots that enter the subsoil can utilize its valuable moisture reserves, making a critical difference during a drought. Proper fertilization of the topsoil will encourage much deeper root development. On the other hand, poor drainage and excessive acidity in the subsoil will hinder or prevent root penetration.

Handling Crop Residues

There are three basic ways of handling the previous crop's residues (stalks, leaves, branches) when preparing land: burning, burying and mulching:

1. Burning - This destroys the organic matter contained in the residues, but may be the only feasible solution where suitable equipment is lacking or where time is short.
2. Burying - chopping residues up with a disk harrow or slasher and then plowing them under is a common practice in mechanized farming.
3. Mulching - Chopping up residues and leaving them on top of the ground has some definite benefits such as greatly reducing soil erosion caused by rainfall and wind as well as water losses due to evaporation. However, there are two disadvantages to mulching which should be considered:
 - Residues are left on the surface and can interfere with the operation of equipment such as planters, plows, and cultivators which may plug up.
 - Mulching is not recommended for peanuts, especially in wet regions, since they are very susceptible to Southern stem rot (Sclerotium rolfsii), which can incubate on unburied residues from any type of plant.

Animal versus Tractor Power: Some Considerations for the Small Farmer

In the developing countries, tractor power and its associated equipment are mainly confined to large farms and to areas where labor costs are high. The large investment, fuel and repair costs, and maintenance requirements all weigh heavily against the purchase of such machinery by small farmers. Spare parts and the necessary repair facilities are commonly lacking, meaning that a breakdown can be disastrous. A study by ICRISAT on the economics of full-size tractors in India showed new evidence that they significantly increase yields, cropping intensity, timeliness or gross returns per hectare. Money can usually be much better spent on animal traction equipment, improved seeds, fertilizers, and other highreturn inputs.

However, there are two situations where tractor power can be justified:

- Animal-drawn equipment may not be sufficient to meet the production needs of the intermediate farmer who has about 5-20 ha of land. In this case, small horsepower equipment may be very suitable. The International Institute for Tropical Agriculture (IITA) farming systems program has

developed a 5 hp gasolinepowered multipurpose equipment unit that can plant field crops with a two-row "punch" planter, haul 500 kg in a trailer, and convert to a walk-behind tractor for rotary tillage, ridging, brush slashing, and plowing rice paddies. Other types of low-horsepower units are available from other manufacturers.

- The small farmer can sometimes benefit by hiring tractor work on an as-needed basis during peak periods when his normal labor supply is insufficient to meet demands.

Basic Tillage Equipment for Plowing and Harrowing

Hand Implements: Heavy duty digging hoes can be very effective for small areas. In Kenya, for example, nearly all small holdings are prepared this way, although an average family cannot handle much more than 0.5 ha with this method. In a wet-dry climate, most land preparation takes place when the soil is hard and dry, which poses added obstacles for hand tools. Some extension services recommend that land be prepared at the end of the previous wet season before the soil dries out. However, this is not always possible due to standing crops.

A digging hoe and a heavy duty hoe blade.



One common type of wooden plow. Most of them have metal tips to reduce wear.



Wooden Plow: Designs of wooden plows go back many centuries. They often are animal drawn, and some have a metal tip. They do not invert the soil or bury crop residues but basically make grooves through the soil. Their effectiveness depends a lot on soil type and moisture content. The grooves they make also can serve as seed and fertilizer furrows.

Moldboard plow: This is the ideal plow for turning under grass, green manure crops, and heavy crop residues such as chopped-up maize stalks. It also buries weed seeds deeper and damages perennial weeds more than other equipment. Moldboard plows are available in animal-drawn models (usually just one plow bottom) and tractor models (usually two to six bottoms). Depending on plow size (width of the moldboard as viewed from the front or back) and soil condition, they will penetrate to 15-22 cm.

Unless equipped with a spring trip device, moldboards do not handle rocky soils well. They are not as well suited to drier areas as disk plows. They also encounter problems in sticky clay soils and may form a plow pan (a thin compacted layer that can hinder root growth) if used at the same depth year after year.

A moldboard plow. The moldboard section is curved so that it turns over the soil slice that is cut by the plowshare.

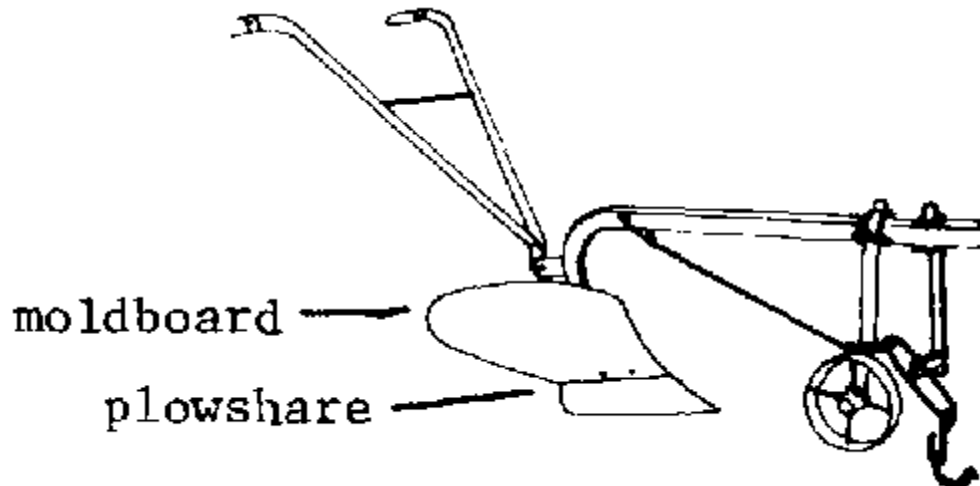

Disk Plow: Better suited than the moldboard to hard, clayey, rocky or sticky ground, but does not bury residues as effectively. This is an advantage in drier areas where surface residues reduce wind and water erosion and cut down moisture evaporation. Disk plows are not recommended for peanut ground where Southern stem rot is a problem, because surface plant residues harbor the spores. They also will not do an effective job turning under grass sod. Disk plows are mainly available in tractor-drawn models. Unlike moldboards plows, they are less likely to form a plow pan if used at the same depth year after year.

A ridging plow or middlebreaker for making raised beds or ridges

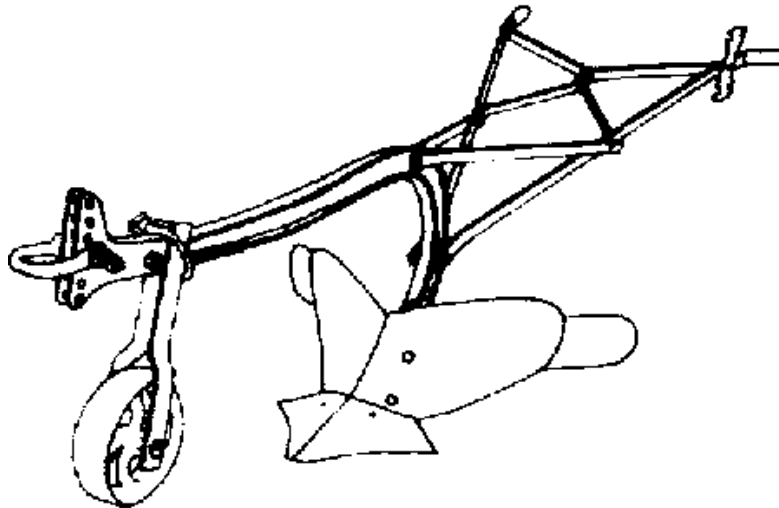

Ridging Plows (Lister Plows or "middlebreakers"). These basically consist of a double-sided moldboard that throws soil both ways. This will produce a series of alternating furrows (trenches) and ridges when operated over a field. Depending on the climate and soil, the crop is either planted in the furrows (in low rainfall areas with no drainage problems) or on top of the ridges (in high rainfall areas or those with drainage problems). Such furrow planting is advantageous in drier areas for cereal crops, since it conserves moisture. Soil is thrown into the row as the season progresses for weed control, and this also

sets the roots deep into the soil, where moisture is more adequate. Such furrow planting is not recommended for peanuts and often not for beans due to increased root rot and stem rot problems.

Rototillers (rotovators):

These are available in tractor-powered models. They thoroughly pulverize the soil and partially bury crop residues. Heavy duty models can be used for a once-over complete tillage job. The disadvantages are that power requirements are very high and the soil can be easily overworked with this implement. In fact, rototillers do a far more thorough job of seedbed preparation than is needed for the reference crops and are best used for vegetable ground.

A rototiller or rotavator. Note the revolving blades under the hood behind the wheels.

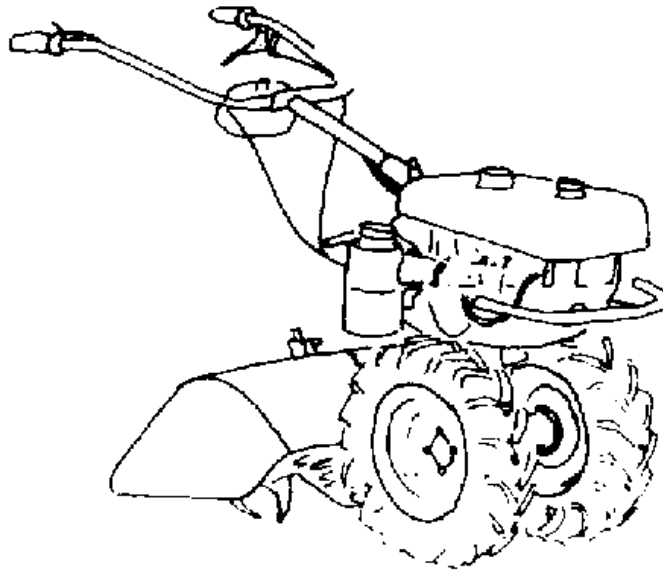

Animal-drawn disk harrow

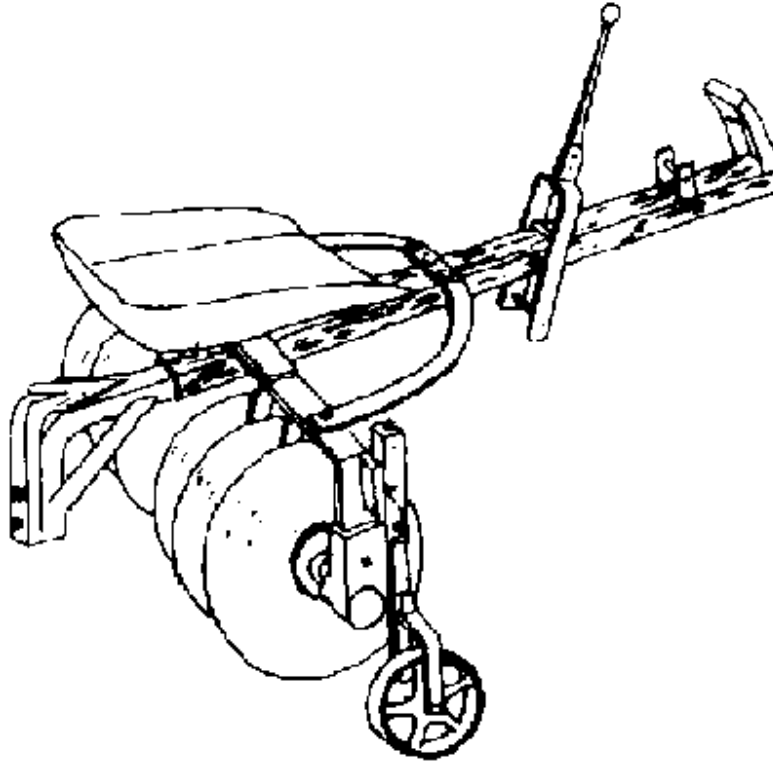

Disk Harrows: Disk harrows are commonly used after plowing to break up clods, control weeds, and smooth the soil before planting. They are also used to chop up coarse crop residues before plowing (especially if a moldboard or disk plow will be used), but heavier models with scalloped disks (disks with large serrations) are most effective for this purpose. Both animal and tractor-drawn models are available but they are expensive and prone to frequent bearing failure unless regularly greased. Large, heavy duty versions pulled by tractors are often called Rome plows and can sometimes substitute for plowing. The gangs of disks are offset to the direction of travel so that they cut, throw, and loosen the top 7.5-15 cm of soil but pack down the soil immediately below that. Repeatedly harrowing a field prior to planting can actually leave it harder than before plowing if done when the soil is moist.

Spike-Tooth Harrows: These consist of a metal or wood frame studded with pegs or spikes; extra weight in the form of stones or logs may be needed under some conditions for maximum effectiveness. They are used to smooth the seedbed and break up clods (at the right moisture content), and are especially suited for killing small weed seedlings that may emerge before planting.

Spike-tooth harrows are made in many widths and are classified by weight and the length of the tines. In some cases, this type of harrow can be run over the actual crop rows from several days after planting up until the seedlings are a few centimeters tall to control early germinating weeds or to break up any soil crusting. Spike-tooth harrows will clog up if trash is left on the soil surface.

Two models of a spike-tooth harrow



A spring tine harrow

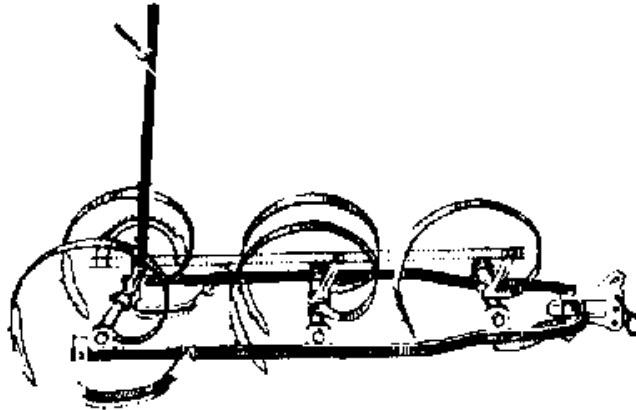

Spring-Tooth Harrows: These have tines made from spring steel that dig, lift, and loosen the top 7.5-10.0 cm of soil, break up clods, and smooth out the seedbed. Both animal and tractor-drawn models are available. They are not suited to hard or trashy ground but handle stones well.

Field Cultivators: These are similar in appearance to chisel plows, but usually are not as built as heavy. They can be used for initial tillage on ground with little surface residue, but are mainly used as a secondary tillage implement for weed control. Most models are designed for tractor use.

(Additional information on the use of animal-drawn equipment can be found in Animal Traction, U.S. Peace Corps Appropriate Technologies for Development Manual Series #12, by Peter Watson, 1981.)

Beans grown on raised beds

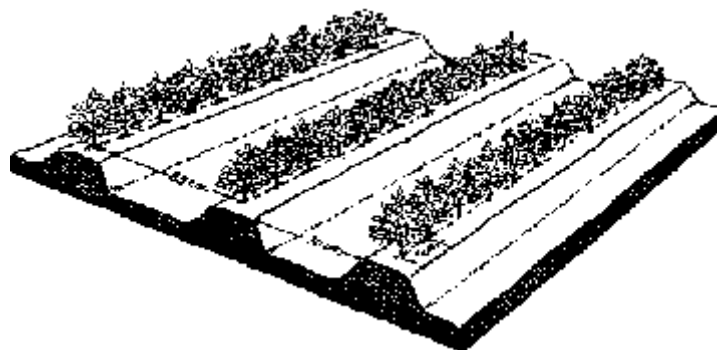

Seedbed Shape

The best seedbed shape depends more on the climate and soil involved than on the particular reference crop.

Flat Seedbeds: This shape is used where soil moisture is adequate for crop growth and where there are no drainage problems. Under such conditions, the reference crops are often planted on a flat seedbed and then "hilled up" with soil (soil is moved into the crop row and mounded around the plants) as the season progresses to control in-row weeds, provide support, and improve drainage. In warm, humid areas where stem rot is a problem, this practice is not recommended for peanuts.

Raised Seedbeds (Ridge or Bed Planting): Under heavy rainfall and/ or poor drainage, the reference crops are usually planted on ridges or raised beds to keep them from getting "wet feet". This also helps minimize soil-borne disease problems like root rots and helps control water erosion if the ridges are run on the contour. Water infiltration is encouraged and runoff minimized. In addition, ridge planting makes for easier entry of digging equipment when peanuts are harvested. Finally, more topsoil is provided for crop growth under this system. The main disadvantage of ridge planting is the accelerated loss of soil moisture from the mounds--normally not a serious problem in wet areas except during dry spells. In drier areas mulching would be beneficial. In regions where the wet season starts out slow, the crops may be flatplanted and then later "hilled up" as the rains increase. Furrow irrigation always requires ridge planting.

Furrow Planting: Under conditions of low rainfall or poor soil water-holding capacity (i.e., sandy soils), crops are often planted in the furrow bottom between ridges where soil moisture is greater. Soil can then be thrown into the furrows to control in-row weeds and improve drainage (if rainfall picks up) as crop growth progresses. This type of sunken planting is not recommended for peanuts in moist areas, since it encourages stem and root rots, particularly if soil is thrown into the row.

Note: Local farmers usually have good seedbed experience, so beware of tampering with time-tested methods without first considering all the angles and running some trials.

Equipment for Seedbed Shaping

Flat seedbeds usually require no special efforts beyond plowing and possibly harrowing. If additional land leveling is required, the small farmer without access to special tractor-drawn leveling equipment can do a satisfactory job dragging a heavy board hitched to two draft animals over the field.

Ridges or beds can be made with digging hoes, special ridging plows (see tillage equipment section) or tractor-drawn disk-bedders (rolling disks arranged at opposing angles to throw soil up to form beds). The crop can be planted either on top of the ridges or in the furrows, depending on the soil and climate.

Summary of land preparation recommendations for the reference crops

Land preparation is a very location-specific practice varying with climate, soil type, crop, management level, and available equipment. The following is a summary of the principal factors involved in choosing the most feasible and appropriate land preparation method and seedbed shape for the reference crops:

1. Seedbed Fineness (thoroughness of preparation)

- Maize's large seeds and spike-like emergence gives it the best clod-handling ability of the reference crops.
- Rough (cloddy) seedbeds discourage weed growth and reduce erosion caused by rain or wind; they also increase water retention by cutting down water runoff.
- The reference crops can tolerate a rougher seedbed when planted by hand than when typical mechanical planters are used.
- To cut down on soil compaction and other effects of overworking the soil as well as to reduce labor, machinery and fuel costs, it is best to use the minimum amount of tillage consistent with adequate seedbed preparation.

2. Tillage Depth

- There is seldom any advantage to plowing deeper than 15-20 cm.
- Shallower plowing may be advisable in drier areas to reduce wind erosion and moisture losses.

3. Crop Residue Management

- Leaving crop residues on the soil surface is especially advantageous in drier areas since it reduces moisture losses and wind erosion. It also reduces erosion due to rainfall and increases water retention.
- When growing peanuts (and sometimes beans), complete residue burial is usually recommended where Southern stem rot (Sclerotium) is a problem, since the disease can incubate on surface plant residues.
- With the other reference crops, surface residues may sometimes aggravate certain insect and disease problems.

4. Suitability of Equipment

- The moldboard plow is the most effective implement for burying crop residues and grass sod.
- A disk plow is better suited than the moldboard to hard, clayey, rocky or sticky ground but does not bury residues or grass sod effectively.
- Chisel plows are best suited to lower rainfall areas and leave trash on top of the soil. They are fairly ineffective on wet soils.
- Disk harrows handle clods better than spike- (peg) tooth and spring-tooth harrows but are more costly and prone to repair problems.

5. Seedbed Shape

- Ridge planting is recommended for all the reference crops under high rainfall or poor drainage.
- Flat planting is best suited to soils with good drainage. However, soil can be mounded into the crop row as growth progresses to control weeds and improve drainage if rainfall increases.
- Furrow planting is best suited to low rainfall areas since it conserves moisture.
- Peanuts and beans are especially susceptible to root rots favored by excess moisture. They should be either flat-planted or ridge-planted.

Seed selection

Factors Affecting Variety Selection

The selection of a locally-adapted variety with good yield potential and acceptable grain characteristics is fundamental to successful crop production. There are several important variety-related characteristics that should be considered when selecting seeds:

1. Yield potential: This is related to inherent natural vigor and other characteristics listed below.
2. Time to maturity: Varieties fall into three general maturity classes: early-, medium- and late-maturing (when grown under similar temperatures). Early varieties produce a crop more quickly, but yields may be about 10-15 percent lower compared with slower-maturing types if both receive adequate moisture.

However, early varieties are especially well suited to short rainy seasons or sequential cropping. Since temperature has a strong influence on a variety's actual length of growing period, some countries like the U.S. are now labeling maize varieties in terms of the growing degree days (total heat units) required for maturity rather than calendar days.

3. Elevation adaption: This has to do with a variety's time to maturity and growth ability at different elevations and temperatures. In regions with pronounced variations in elevation such as Central America, the Andean countries, and Ethiopia, maize and sorghum varieties are classified according to their elevation adaption (i.e., 0-1000, 1000-1500, etc.); a similar system may also be used for beans and other pulses.

4. Heat or cold tolerance: Varieties vary in their tolerance to excessive heat or cold.

5. Drought tolerance: Even varieties within a crop can vary considerably in this respect. In a 1978 International Maize and Wheat Improvement Center (CIMMYT) maize trial, a variety selected for drought tolerance outyielded the best full-irrigation variety by 64 percent under conditions of severe moisture shortage.

6. Resistance (partial tolerance) to insects, diseases, and nematodes, as well as to bird damage and soil problems such as excessive acidity and low phosphorus levels. Reference crop varieties can differ considerably in their tolerance to these problems, which are some of the major concerns of plant breeding work. Resistance to lodging also is an important consideration in selecting a maize variety.

7. Growth habit and other plant characteristics: For example, bean varieties can be bush, semi-vining or vining in their growth habit; millet varies in tillering ability and sorghum in its ratooning potential. Plant height and the ratio of leaf and stalk also varies with variety.

8. Daylength sensitivity (photosensitivity) varies markedly among sorghum and millet varieties.

9. Seed color, shape, size, storability, etc.

Traditional Versus Improved Varieties

In selecting a variety, it is important to understand the differences between traditional varieties, hybrids, synthetics, and other improved varieties.

1. Traditional (local) varieties: They tend to be relatively low-yielding but are usually hardy and have fair to good resistance to local insect and disease problems. However, most are adapted to low levels of soil fertility and management and often do not respond as well as improved types to fertilizer and other improved practices. Native varieties of maize, sorghum and millet tend to have an overly high ratio of stalk and leaves to grain, but this may be an advantage where lives are important.

Despite certain disadvantages, local varieties may be the best choice in some situations. During the first years of the Puebla maize project in Mexico, some of the local varieties consistently outyielded anything the plant breeders could come up with.

2. A hybrid is a type of improved variety produced by crossing two or more inbred lines of a crop. This is relatively easy to do with maize and sorghum, and a number of hybrids are available to these two crops. Hybrid development in peanuts, beans and the other pulses has proven more difficult, and they are not yet generally available. Millet research is still at too early a stage for hybrids to assume much importance.

When grown under similar conditions, an adapted hybrid may out-yield the best adapted, normally-produced varieties by 15-35 percent, but not always. Despite these possible yield benefits hybrids have several disadvantages:

- Unlike naturally produced varieties, the seed harvested from a hybrid should not be replanted by the farmer. If reseeded, a hybrid begins to degenerate and revert back to the original (and usually less desirable) lines from which it was developed. Yields may drop as much as 15-25 percent each successive crop. Many small farmers lack the inclination or the money to buy new seed for each planting unless special arrangements and educational efforts are made.
- Hybrid seed may be several times more expensive than that of other types.
- Hybrids require good management or they may not yield much more than other types.
- Hybrids show a narrower range of adaptation to different growing conditions than other varieties; this makes finding a suitable hybrid more difficult. It is estimated that 131 different hybrids had to be developed to suit varying maize growing conditions in the U.S.

3. Synthetics are improved varieties that have been developed from cross-pollinating lines (naturally pollinated with no purposeful inbreeding as in hybrids). These lines are first tested for their combining ability and then crossed in all combinations. Synthetic varieties often yield as well as hybrids under small farmer conditions and have several advantages over them:

- They have greater genetic variability than hybrids, which makes them more adaptable to different growing conditions.
- The seed costs less than that of hybrids.
- Unlike hybrids, seed harvested from a synthetic can be replanted without loss of vigor as long as farmers are willing to select it from the plants with the best characteristics.

4. Varieties improved through mass selection: This is the most elemental form of varietal improvement and consists of natural crossing between lines with no attempt made to test for combining ability (as with synthetics) and continually selecting seed from plants showing the best combination of desirable characteristics. While yields may not be as good as those from hybrids or synthetics, the seed is cheaper and also can be replanted.

Guidelines for Selecting Quality Seed

Seed quality can be influenced by the following factors:

1. Varietal purity: Farmers who use their own harvested seed for replanting can be reasonably assured of varietal purity, especially with crops that are naturally self-pollinated (millet, sorghum, peanuts, cowpeas, beans, and most other pulses). Since maize is cross-pollinated, there is opportunity for "contamination" from other nearby maize varieties. This can be minimized by selecting seed for replanting from the inner part of the field.

Commercially available seed may or may not have good varietal purity, depending on its source and the country's commercial seed standards. In some areas, certified seed is available with guaranteed genetic purity and tested germination.

2. Germination and vigor depend largely on the seed's age and the conditions under which it has been stored. High temperature and humidity as well as insect damage (weevils, etc.) can drastically reduce both germination and vigor. Certified seed is usually labeled with a tested germination percentage, but post-tested storage conditions can make this a worthless guarantee. You should encourage farmers to run their own germination test before planting any seed, regardless of source.

3. Visual traits: Mold, insect damage, cracking, and shrunken or shriveled seed mean trouble.

IMPORTANT NOTE: Beans, soybeans and shelled peanuts are very susceptible to damage from rough handling of dry seeds in harvesting, processing, and shipping. Dropping a sack of beans on a

cement floor is enough to harm them. Both the seedcoats and seeds crack very easily; careless handling can also cause invisible damage. In both cases, these injuries can lead to stunted, malformed seedlings lacking in vigor.

4. Impurities such as weed seeds; These are more of a problem in crops with small seeds like millet and sorghum, where separation is more difficult.

5. Seed-borne diseases: Some diseases like anthracnose may show visible symptoms on contaminated seed, while many others do not. Certified seed, if grown under the proper procedures of inspection and roguing (elimination of diseased plants), is free from certain seed-borne diseases and is especially recommended for beans when available. Some common fungal diseases are carried mainly on the seed coat surface and can be controlled by dusting the seed with a fungicide; others (especially viruses) are internal and have no control.

How to Select Home Grown Seed

Most farmers not using hybrid will set aside some of their harvested seed for replanting future crops. This is fine as long as the variety is suitable, storage methods are adequate, and seed-borne diseases are not a problem. If the guidelines below are followed, the farmers actually may be able to improve the varieties they are using or at least prevent a decline in their performance:

1. Seed selection should start while the crop is still growing in the field: Most farmers wait until after harvest to select seed for replanting and go largely by seed or ear size. Selecting maize seed from the largest ears may have little, if any, value. This is because the ear's size may be due less to the plant's inherent genetic ability than to environmental or management factors like fertility, plant density, and available moisture.

2. When selecting plants as potential seed sources, keep in mind the important plant characteristics that favor good yields:

- General: Resistance to disease, insects, drought and nematodes; general plant vigor, ratio of stalk and leaves to grain, and time to maturity.
- Maize: Resistance to lodging, extent and tightness of husk covering (for insect, bird, and water resistance), and number of well-formed ears per plant.

When selecting maize plants, make selections from well within the field to avoid possible cross-pollination, so this is not a problem with them.

3. Mark the selected plants with cloth or stakes.

4. Additional guidelines for maize: When choosing among good ears after harvest, physical differences like the number of kernel rows, kernel size, and filling of the tips and butts of the cob are relatively useless as indicators of yield potential. However, the very small, misshapen seeds at the extreme ends of the cob should be discarded. Check also for uniformity of kernel color and for insect damage.

How to Conduct a Germination Test

Farmers should be encouraged to run a germination test on seed before planting, regardless of the source. The same holds true for extension workers receiving shipments of improved seed. Germination figures that appear on seed labels can be inaccurate even if the tests were conducted fairly recently. Warm, humid conditions in the tropics can rapidly lower the germination rate. To run the test:

- Count out 100 seeds and place them on top of several thicknesses of moist newspaper. Spread them out enough so you can distinguish which ones have germinated.

- Carefully roll up the moist newspaper so that the seeds remain separated from each other and stay pressed against the newspaper. Place in a plastic bag or periodically re-moisten the newspaper to keep it from drying out.
- Sprouting time will vary with temperature, but you should be able to get a good idea of germination within three to five days unless it is unusually, cold. Good seed should have a germination rate of at least 80-85 percent under these conditions. Up to a point, you can compensate for low germination by planting more seed, but below a rate of 50 percent or so seedling vigor may suffer also.

It is a good idea where possible to supplement this type of test with an actual field test, since soil conditions are not usually as ideal. Plant 50-100 seeds, keep the soil moist enough, and then count the emerged plants. If germination is very much lower than with the newspaper method, do some troubleshooting to see if insects or seeds may have caused problems.

Planting

The Goals of Successful Planting

When planting, farmers must accomplish four objectives in order to promote good crop yields:

1. Attain an adequate stand (population) of plants. This requires seed with good germination ability, adequate land preparation, sufficient soil moisture, correct planter calibration (adjustment) if mechanical planters are used, proper planting depth, and control of soil insects and diseases that attack seeds and young seedlings. In some areas, birds and rodents also cause problems.
2. Attain the desired plant spacing both in the row and between the rows.
3. Observe timeliness in land preparation and planting. The right time to plant depends on the crop's characteristics (i.e., peanuts should be planted so that harvesting will be likely to occur during reasonably dry weather), the onset of the rains and overall rainfall pattern, the influence, if any, of planting date on insect and disease problems such as sorghum head mold.
4. Use the right type of seedbed for the particular crop, soil, and climate.

Planting Methods And Equipment

1. Hand planting with a planting stick, hoe or machete: This is the most common method used by small farmers in the developing world.

Advantages

- Equipment costs are negligible.
- Less thorough seedbed preparation is needed than for most mechanical planters. The farmer who hand plants can push large clods out of the way while walking down the row or can plant directly into untilled soil.

Disadvantages

- Time and labor requirements are high: it takes three or four person-days to plant a hectare by hand.
- When hand planting, farmers usually put several seeds in each hole and space the holes rather far apart, partly to save labor. This practice can often reduce yields by resulting in too low an overall seeding rate and too much competition among the plants that emerge from the same hole.

2. Improvements in Hand Planting

- Hand-operated, mechanical "punch" or "jab" planters are available that make the planting holes and drop in the seed in one movement (the seed is automatically metered out from a reservoir). They are operated like an ordinary planting stick (jabbed or punched into the ground) but are much quicker and are also very useful for filling in any "skips" (vacancies) in larger fields. A hectare of maize can be planted in 15-20 person-hours. The farming systems program of IITA in Nigeria has designed a very successful punch planter suitable for planting maize, sorghum, cowpeas, beans, and soybeans into untilled ground. It is also capable of planting through a dried mulch. The IITA punch planter can be built in a workshop with access to metal shears (no welding is needed). (Write IITA for plans.) Other types of punch planters are available commercially in some countries.
- Hand-pushed planters: Most models require a fairly loose clod-free seedbed for satisfactory operation. However, IITA's farming systems program has designed a very effective rolling punch planter (called a rotary injection planter, see illustration) that can be built in any workshop with welding and metal-shearing capabilities and is being manufactured by Geest Overseas Mechanization Ltd., West Marsh Road, Spalding, Lincolnshire PE11-2BD, England (price is about \$225 U.S.). The rotary injection planter uses the same principles as the hand punch planter, but has six punch-injection devices on a rolling wheel plus a following press wheel to firm down the seed row. The standard design produces a seed spacing of 25 cm, but alternate rollers can be made for different spacings. The rotary injection planter is also available as a four-row, hand-pulled model for planting direct-seeded rice.
- Hand planting into furrows made with an animal- or tractor-drawn implement: A wooden plow, cultivator shank or other implement can be used to make seed furrows in plowed ground. If certain precautions are followed, the fertilizer can be placed in the same furrow.
- Reasonably parallel crop rows are required if weeding is to be done with an animal- or tractor-drawn cultivator. Farmers can easily construct a parallel row "tracer" consisting of a wood or bamboo frame with hardwood or steel teeth for marking out rows. (A design for this handy implement can be found in the Peace Corps' Animal Traction manual.)
- Improved seed-spacing accuracy can be achieved by running a rope or chain down the row with knots or paint marks to indicate the proper spacing. Otherwise, farmers commonly make large errors in spacing when using planting sticks or dribbling out seeds into a plowed furrow.

3. Animal- and tractor-drawn mechanical planters are available in many different models. A farmer using a one-row animal-drawn planter can sow about 1-1.5 ha in a day and about 5-8 ha using a two-row tractor-drawn planter.

Here are some important considerations concerning these types of planters:

- Most mechanical planters require a more thoroughly prepared seedbed than is needed for hand planting. Some models have special soil openers that permit satisfactory operation in hard or cloddy soil.

An animal-drawn planter with a separate hopper for banding fertilizer

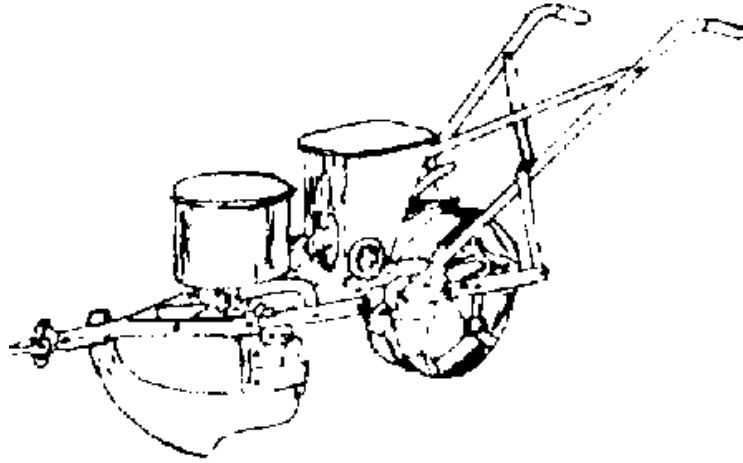

The IITA designed hand-operated "jab" or "punch" planter, which can be made in a workshop. The attached metal bracket firms the soil over the seed and spaces the next seed insertion.

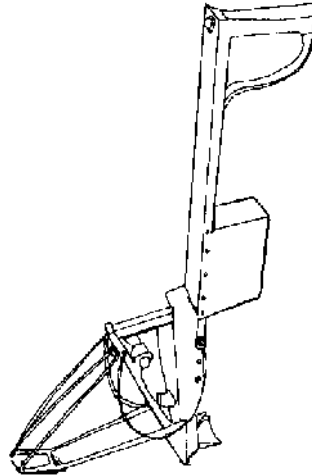

The rolling "punch" planter developed by IITA and now manufactured commercially. It also can be built in a workshop.

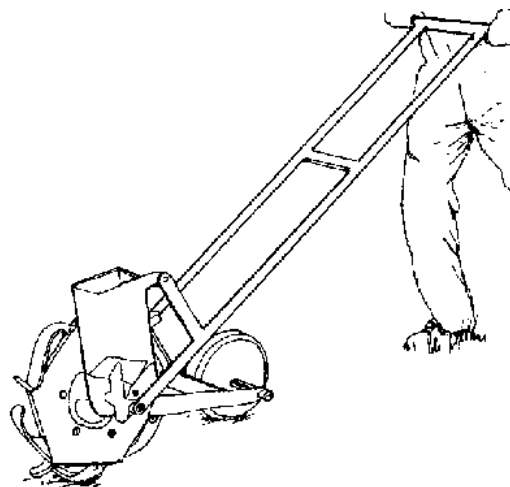

A hand-pushed fertilizer band applicator. This model places the fertilizer below the soil surface, which is essential for phosphorus-bearing fertilizers. The attachment at the left is used to close the furrow but usually is not needed.

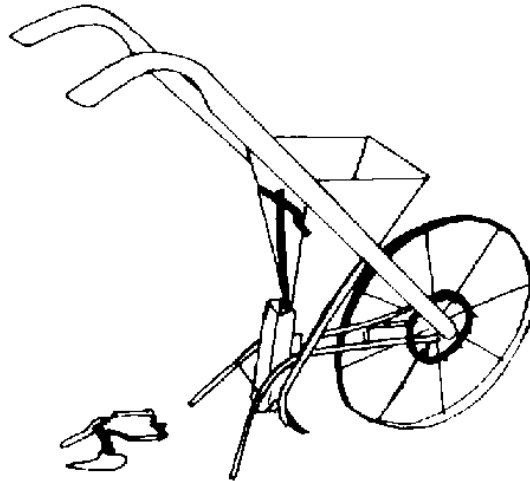

- The farmer must be able to calibrate (adjust) the planter so that it drops the seeds at the correct intervals along the row.
- Some models have attachments for applying fertilizer in a band beneath the soil and slightly to the side of the seed row. This is an especially effective method for fertilizers containing phosphorus.

Farmers using planters without fertilizer applicators will often broadcast the fertilizer and plow it under before planting or leave it on top of the ground; this should not be done with fertilizers containing phosphorus! Farmers buying mechanical planters should be encouraged to purchase a fertilizer attachment if available and effective. (NOTE: The applicator should not dribble the fertilizer on top of the ground or place it in direct contact with the seed.)

Plant Population And Spacing

Both plant population and spacing affect the yields of the reference crops, and extension workers should understand the relationships.

Plant Population and Its Effects on Crop Yields

- Up to a point, crop yields will increase along with increases in plant population until the competition for sunlight, water, and nutrients becomes too great.
- Excessively high populations will reduce yields, encourage diseases, and seriously increase lodging in maize, sorghum and millet by promoting spindly, weak stalks.
- Excessively low plant populations will cut yields due to unused space and the limitations on maximum yield per plant.
- Under most conditions, changes in plant population will not affect yields as much as might be expected. This is because most crops have a good deal of built-in buffering capacity, especially if the population is too low. In this case, the plants respond by making yield-favoring changes such as increased tillering (millet, sorghum) and branching (peanuts, other pulses), more pods or ears per plant or larger ears or grain heads. In maize, a plant density that is 40 percent below the optimum for the given conditions may lower yields by only 20 percent.
- Plant population changes have a more pronounced effect under conditions of moisture stress

What is the ideal plant population?

There is no easy answer to this, because the optimum plant density depends on several factors:

- Type of crop and variety: Because of differences in plant size and architecture, crops and their varieties vary in their tolerance to increasing plant populations. For example, early maturing maize varieties are usually shorter and smaller than later maturing ones and therefore may benefit from higher plant densities. Beans and cowpeas respond well to populations three to four times higher than for maize due to their smaller plant size and a growth habit that favors better light interception.
- Available soil moisture: The optimum plant population density varies directly with rainfall and the possibility of moisture stress. Plant population has a stronger effect on yields under low moisture conditions than when moisture is adequate. This is because increased populations also increase water use, although plant spacing can make a difference. This is particularly true for maize and sorghum, because yields can be significantly reduced by relatively small increases in plant population when grown under moisture stress.
- Available nutrients: Adequate soil fertility is especially essential with high plant populations. In fact, fertilizer response is often disappointing when plant populations are too low for the given conditions. In fact, this is one of the main reasons that small farmers often do not get their money's worth out of fertilizer. An ear of maize can only grow so big, and even high rates of fertilizer can not make up for too few ears produced by a small number of plants.
- Management ability: High populations require more soil fertility and moisture as well as better overall general management.

Plant Spacing and Its Effects on Crop Yields

The reference crops are row crops for some very good reasons. A row arrangement permits quicker and easier weeding and facilitates most other growing operations. Row cropping with its handy space for equipment, animal, and human traffic allows for ease of mechanization and handling, no matter what the level of sophistication. Distributing a given plant population over a field involves both plant spacing within the row and the distance between the rows (row width).

Plant spacing within the row: The number of seeds that need to be planted per meter or foot of row length depends entirely on the plant population and row widths that have been chosen according to recommendations. The main concern then becomes whether hill planting or drill planting should be used. In drill planting mechanical planters drop seeds out one at a time along the row. Small farmers who hand plant their crops usually use hill planting, sowing several seeds per hole and spacing the holes rather far apart. This reduces time and labor and also may improve seedling emergence under crusty soil conditions, but it may lower yields somewhat because of inefficient use of space and increased competition between the plants within a hill for sunlight, water, and nutrients.

Row Width: Space between rows is determined by the type of equipment used as well as by plant size or "spread". The use of tractor-or animal-drawn equipment requires more space between rows (wider row widths) than when only hoes and backpack sprayers are used. Beans can be spaced in narrower rows than maize or other tall crops and still be weeded with an animal-drawn cultivator without knocking the plants down. Row width influences crop yields in four ways:

- As row width is narrowed, the plants can be spaced farther apart within the row and still maintain the same population. Up to a point, this makes for better weed control due to earlier and more effective between-row shading by the crop.
- Narrower rows allow for higher plant populations without overcrowding.

- As row width is widened, plants have to be crowded closer together within the row in order to maintain the same population. This may lower yields.

Should the use of narrower rows be encouraged? Here are some things to consider:

1. Switching from 100 cm to 75 cm rows in maize and sorghum may increase yields by as much as 5-10 percent when total plant population is kept constant.

When grown alone, bush beans and bush cowpeas are usually planted in narrow rows (45-60 cm) by most small farmers. Under good management and yields, most studies have not shown much advantage to reducing peanut row width below 75-100 cm. Given the marginal moisture conditions under which millet is grown, row widths less than 75-100 cm are unlikely to be advantageous.

2. Row width and moisture use: Although narrower rows cut down water evaporation from the soil surface because of earlier and more complete soil shading, this is often negated by increased plant water use (transpiration) due to better leaf exposure to sunlight. Under low moisture conditions, plant population has a much greater influence on water use than row width.

3. It is doubtful that a 5-10 percent yield increase will have much of an influence on small farmers whose yields are fairly low. Even if yields are good, switching to narrower rows may cause more problems than it is worth:

- Narrow rows cost the farmer more in terms of time, seed, and pesticide. That is because the narrower the row width, the greater the total amount of row length per hectare or other land unit, since there are simply more rows to deal with.
- If tractor-drawn equipment is used, overly narrow rows may increase plant damage from tractor tires and passing equipment as well as increase soil compaction near the row zone. If several crops are being grown under tractor cultivation, it is more convenient to settle on a standard row size rather than be constantly readjusting tire spacing, tire size, and cultivator tine spacing. Remember, too, that row width must be kept wide enough to permit tractor cultivation (weeding). This cannot be done by relying solely on herbicides!

Summary of Plant Population and Spacing Studies Conducted with the Reference Crops

MAIZE: Overly high populations cause increased lodging, barren stalks, unfilled ears, and small ears. Dry, husked ears weighing more than 270-310 g indicate that plant population was probably too low for the conditions and that yields might have been 10-20 percent higher. Ear size of prolific (multiple-ear) varieties will not vary as much with changes in plant density as will single-ear varieties; rather the number of ears per plant will decrease as density increases.

Hill versus drill planting: Numerous trials with maize have shown yield increases of 0-13 percent when drill planting (one seed per hole) was substituted for hill planting at two to three seeds per hole. However, lodging appears to be more of a problem with drill planting. Farmers who are hand planting four to six seeds per hole should be encouraged to switch to two to three seeds per hole and space the holes close enough together to achieve the desired plant population. It is doubtful that switching to drill planting is worth the extra labor involved under hand planting.

Under adequate moisture and fertility, optimum plant populations vary from about 40,000 to 60,000 per hectare. Plant size, management, fertility, and the variety's tolerance to plant density and available moisture must be considered when making population changes. Studies also show that overly high populations have a negative effect on maize yields when moisture is low.

SORGHUM: Optimum plant population varies markedly with available water, plant height, tillering ability, and fertility. In varieties that tiller well, plant population is less important than with maize since the plants can compensate for overly low or high populations by varying the production of side shoots.

In West Africa, the improved long-season photosensitive and the improved short-season non-sensitive varieties are sown at the rate of 40,000-80,000/ha under good management; the dwarf photosensitive, long-season varieties are sown at rates of 100,000/ha or more.

All the above populations are based on monoculture.

PEARL MILLET: In West Africa, millet is planted in hills usually a meter or more apart; many seeds are sown per hill, and thinning takes place two or three weeks later. This involves much hand labor and is seldom finished before serious competition has taken place. Trials in Upper Volta by ICRISAT showed that millet germinated best when planted at many seeds per hill and that hill planting outyielded drill planting. However, other ICRISAT work in West Africa showed no difference between yields from hill and drill plantings.

Population and spacing: In West Africa, pearl millets of the Gero type are often interplanted at populations of 7500-8500 plants per hectare with two to three other crops. The taller, long-season Maiwa types are sown at 40,000-80,000 plants/ha when planted alone under good management. For improved dwarf Geros, populations over 100,000/ha are recommended.

Most varieties have a strong tillering ability and adjust themselves to varying densities through changes in tiller production. Within limits, yields are not greatly affected by plant population changes.

PEANUTS: In parts of West Africa, peanuts are frequently interplanted in combination with sorghum, millet, and maize. Because peanuts are the most valuable, the tendency is to keep the cereal population down to about 3000-6000 hills per hectare and the peanut density high at about 30,000 hills per hectare, or about the same as under sole cropping.

In West Africa, the recommended plant population for improved varieties grown alone ranges from about 45,000-100,000/ha. Rows vary from 24-36 inches (60-40 cm) and seed spacing in the row from 15-25 cm. For the Virginia types populations of 45,000-60,000/ha have been found to be optimum, with higher populations recommended for the Spanish-Valencia types.

Early studies in the U.S. in the 1940's and 1950's obtained yield increases of 30-40 percent by switching from row widths of 90 cm to 4560 cm. At that time, however, average yields were relatively low (1550 kg/ha). As yields have increased over the years, the importance of row width has diminished considerably, and most U.S. growers are using 75-95 cm widths with one seed every 10 cm. A stand of one plant every 15-20 cm is felt to be adequate, but overplanting is needed to make up for any losses.

Two new developments may influence row widths: 1) smaller-size, dwarf varieties which will not fully spread out to cover a 90 cm row width. 2) Plant growth regulators like Alar, which are internodes shorteners (internodes are the spaces between nodes on the stem and branches) which decrease plant size and are especially suited to runner types.

BEANS: The International Center for Tropical Agriculture (CIAT) studies in Colombia have shown that bush beans grown alone give highest yields in spacings of either 30 cm between rows and 9 cm between plants 45 cm between rows and 60 cm between plants (equivalent to about 400,000 seeds/hectare). A yield plateau is usually reached around 200,000-250,000 actual plants per hectare, but stand losses from planting to harvest are often in the 25-40 percent range, meaning that considerable overplanting is necessary. High density plantings also appear to increase the height of the pods from the ground, which lessens rotting problems. However, very narrow rows aggravate Sclerotium stem rot where it occurs.

Studies by CIAT and the Center for Tropical Agriculture, Research and Training (CATIE) indicate that plant populations for bush beans in the range of 200,000-250,000/ha are also ideal when grown together with maize.

Trials with climbing beans show that final plant populations of 100,000-160,000/ha are optimum, whether grown alone with trellising or with maize.

COWPEAS: In West Africa, improved cowpea varieties of the vining type are grown at population densities ranging from 30,000-100,000/ha in rows 75-100 cm apart.

CHICKPEAS: An ICRISAT study showed that yields remained relatively stable over wide ranges of plant density (4-100 plants per square meter).

Guidelines for Attaining a Good Stand and The Desired Spacing

Eight key factors largely determine whether a farmer actually ends up with a good stand of plants and the right spacing for the conditions:

- Seed-germination ability
- Percent of overplanting
- Planting depth
- Seedbed condition (clods, moisture, etc.)
- Seedbed type (flat, furrow or ridge planting)
- Accurate measurement when hand planting and calibration of mechanical planters
- Soil insects and diseases
- Fertilizer placement.

Seed-germination ability

Always run a germination test (see before planting; good seed should test out at close to 90 percent. Up to a point, overplanting will compensate for lower germination, but seed testing below 50 percent germination should not be used since seedling vigor is also likely to be affected.

Percent of Overplanting

No matter how well the seed germinates, the farmer should still overplant to make up for any added plant losses due to insects, diseases, birds, and weeding operations. When using good seed, it is usually a sound practice to overplant by 15-20 percent in order to assure the recommended final stand of plants at harvest. Of the reference crops, beans, cowpeas and peanuts are likely to suffer the greatest plant losses and will usually benefit from even higher overplanting. Much depends on the specific growing conditions. High rates of overplanting (500 percent or more) followed by heavy hand thinning are a standard practice when field planting small vegetable seeds like cabbage, tomatoes, and lettuce. This is not recommended for the reference crops, since their seeds are larger, hardier, and more vigorous in their early growth. Labor and seed costs are excessive with high overplanting and thinning. Millet is commonly thinned in West Africa after being overplanted heavily, but this should be discouraged.

Planting Depth

Optimum planting depth varies with the crop, soil type (sandy versus clayey), and soil moisture content. Seeds should be placed deep enough so that moisture is available for germination, but shallow enough so that seedling emergence is not impaired. Local farmers should be regarded as the ultimate authority on the best planting depths, but here are some general guidelines:

- Seeds can be planted deeper in sandy soils than in clayey soils without reducing plant emergence.
- Planting depth should be deeper under low soil moisture conditions.
- Large seeds have more emergence strength than small ones, but this is also affected by the seedling's structure. Maize, millet, and sorghum push through the soil with spike-like tips which aid emergence. Peanuts, beans, and the other pulses emerge in a much more blunt form.

Normal Ranges in Planting Depths for the Reference Crops

Maize:	3.75-8 cm
--------	-----------

<u>Sorghum:</u>	3.75-6 cm
<u>Millet:</u>	2-4 cm
<u>Peanuts, Beans, Cowpeas.</u>	3-8 cm

Seedbed condition

Cloddiness and soil moisture will affect germination. Some soils, especially those high in silt, tend to form a hard surface crust when drying out after a rain. This can sometimes seriously reduce emergence, especially for the pulses. If necessary, these crusts can be broken up with a spike-tooth harrow or other homemade device.

Seeds should be in reasonably firm contact with moist soil. Most tractor-drawn planters have steel or rubber "press" wheels running behind them to help improve seed and soil contact. (See for more information on seedbed preparation.)

Seedbed type

Most of the crops can be flat-, furrow- or ridge-planted according to the particular soil and climate conditions. Good drainage and freedom from ponding (standing) water is especially vital for peanuts, beans, and cowpeas, which are particularly susceptible to root and stem rots. They should be flat-planted where drainage is good or sown on top of ridges or beds where drainage is poor. If flat-planting, care should be taken not to form a depression along the seed row where water could collect. This is a problem where mechanical planters with heavy press wheels are used, but can be avoided by using wider press wheels and throwing extra soil into the row ahead of the planter with cultivator sweeps.

Planter calibration; accuracy of hand planting

Mechanical planters must be calibrated (adjusted) prior to planting to assure that they space the seeds out correctly.

Hand planting is prone to large errors in row width and seed spacing unless some effort is made to assure accuracy. The use of a planting rope or chain along the row with knots or paint marks to indicate the spacing is recommended.

Soil insects and diseases

Seeds may need to be treated with a fungicide dust to help control seed rots which are especially serious under cool, wet conditions. Seed or soil treatment with an insecticide may also be needed to protect against damage from insects that attack the seeds and young seedlings.

Fertilizer placement

Fertilizer placed too close to the seeds or in contact with them may prevent or seriously reduce germination. This depends on the kind, amount, and placement of the fertilizer.

5. Soil fertility and management

Fertilizers

Fertilizer use is often the management factor producing the largest increases in reference crop yields. However, yield response is heavily influenced by two factors:

- The control of other limiting factors: Fertilizer usually gives a much better response when used as part of a "package" of improved practices designed to control other major yield limiting factors in addition to soil fertility.

- How fertilizer is used: Good results from fertilizer cannot be expected unless the farmer knows what kind and how much to use, and how and when to apply it.

Aside from water, sunlight, and air, plants need 14 mineral nutrients which are usually grouped as follows:

MACRONUTRIENTS

<u>Primary</u>	<u>Secondary</u>
NITROGEN (N)	CALCIUM (Ca)
PHOSPHORUS (P)	MAGNESIUM (Mg)
POTASSIUM (K)	SULFUR (S)
<u>MICRONUTRIENTS</u>	(not primary or secondary)
IRON (Fe)	ZINC (Zn)
MANGANESE (Mn)	BORON (B)
COPPER (Cu)	MOLYBDENUM (Mo)

The macronutrients make up about 99 percent of a plant's diet. Nitrogen, phosphorus and potassium account for about 60 percent and are definitely the "Big Three" of soil fertility, both in terms of the quantity needed and the likelihood of deficiency (see Table 4).

This does not mean that the secondary macronutrients or the micronutrients are any less essential. True, their deficiencies are not as common, but they can have just as serious an effect on crop yields.

Table 4. Amount of Nutrients Taken Up by a 6300 kg Yield of Shelled Maize

<u>Macronutrients</u>	<u>Kg</u>	<u>Micronutrients</u>	<u>Grams</u>
Nitrogen	157	Iron	4200
Phosphorus (P ₂ O ₅)	60	Manganese	1000
Potassium (K ₂ O)	124	Zinc	30
Calcium	29	Copper	7
Magnesium	25	Boron	7
Sulfur	17	Molybdenum	0.7

Nitrogen (N)

Nitrogen is the most commonly deficient nutrient for non-legumes. It promotes vegetative growth and is an essential constituent of protein and chlorophyll (needed for photosynthesis).

Crops vary in their need for N. Crops with a lot of vegetative (leafy) growth have relatively high N needs. These include maize, sorghum, millet, rice, sugarcane, pasture grasses, and most leafy and fruit-type vegetables. Root crops like potatoes, sweet potatoes, cassava (manioc, yuca), and tropical yams have lower N needs, and excessive amounts tend to favor leafy growth over tuber growth (with the exception of most improved potato varieties which have high N needs).

Legumes are able to satisfy part or all of their N needs themselves through the process of nitrofixation. Peanuts, cowpeas, mung beans, pigeonpeas, and chickpeas are usually able to meet their own N requirements in this way. Common beans (kidney beans) are less efficient at N fixation and may need up to half as much N fertilizer as maize. Too much nitrogen can adversely affect crop growth, especially if other nutrients are deficient:

- It may delay maturity.
- It may lower disease resistance.
- It may increase lodging problems in cereal crops.

Available versus Unavailable N

Only nitrogen in the form of ammonium (NH_4^+) and nitrate (NO_3^-) in the soil is available to plants. However, about 98-99 percent of a soil's total N is in the unavailable organic form as part of humus. Soil microbes gradually convert this unavailable organic N into ammonium and then nitrate. Most soils are too low in humus to supply N at a rapid enough rate for good yields. That is why N fertilizer is usually needed for non-legumes.

Available soil N can become tied up and unavailable when crop residues low in N are plowed into the soil. This is because the soil microbes that decompose the residues need N to make body protein.

Most crop residues like maize, millet, and sorghum stalks supply large amounts of carbon, which the microbes use for energy, but not enough N for the microbes' protein needs. The microbes make up for this shortage by taking ammonium and nitrate N from the soil. A crop may suffer a temporary N deficiency if planted under these conditions, until the microbes finish decomposing the residues and finally release the tied-up N as they die off. (Occasionally even young legumes will be affected.) This type of N deficiency can be prevented easily by applying about 2530 kg/ha of N at planting time when growing a non-legume.

Available N is Easily Lost

Nitrate N (NO_3^-) is much more readily leached (carried downward away from the root zone by rainfall or irrigation) than ammonium N (NH_4^+), since it is not attracted to and held by the negatively charged clay and humus particles. (These act like magnets and hold onto positively charged nutrients like NH_4^+ , K^+ , and Ca^{++} and keep them from leaching).

The problem is that tropical and sub-tropical temperatures are always high enough to promote a rapid conversion of ammonium N to nitrate N by soil microbes. Most ammonium type fertilizers will be completely changed to leachable nitrate in a week in warm soils. The higher the rainfall and the sandier the soil, the higher the leaching losses of N. The best way to avoid excessive leaching is to apply only part of the fertilizer at planting and the rest later on in the crop's growth when uptake is higher.

Phosphorus (P)

Phosphorus promotes root growth, flowering, fruiting and seed formation. Remember these four vital facts about phosphorus:

- Phosphorus deficiencies are widespread: Much of a soil's native P content is tied up and unavailable. Worse yet, only about 5-20 percent of the fertilizer P applied will be available to the crop since much of it also gets tied up as insoluble compounds. This P fixation is especially a problem on highly-weathered, red tropical soils low in pH (high in acidity).
- Phosphorus is virtually immobile in the soil: Phosphorus does not leach except in very sandy soils. Many farmers apply P fertilizer too shallowly and very little gets to the roots.
- Young seedlings need a high concentration of P in their tissues to promote good root growth. This means that P needs to be applied at planting time. One study showed that maize seedlings take up to 22 times as much P per unit of length as do 11-week-old plants.
- Application method is vitally important and determines how much of the added P gets tied up. Broadcast applications (uniform applications of fertilizer over the entire field) maximize P tie-up and should seldom be recommended for small farmers. Placement in a band, half-circle or hole near the seed is two to four times as effective as broadcasting, especially for low to medium rates of application.

Potassium (K)

Potassium promotes starch and sugar formation, root growth, disease resistance, stalk strength, and general plant vigor. Starch and sugar crops like sugarcane, bananas, potatoes, cassava, and sweet potatoes have particularly high K needs. Maize, sorghum, millet, rice, and other grasses are more efficient K extractors than most broadleaf crops. Remember these facts about K:

- Potassium deficiencies are not as common as those of N and P: Most volcanic soils tend to have good available supplies. However, only the soils lab can tell for sure.
- Potassium: Only about one or two percent of the soil's total K is in the available form, but this is often enough to satisfy the needs of some crops. The good news is that tie-up of fertilizer K is not usually serious and never approaches that of P.
- Leaching losses are usually minor: The available form of K has a positive (plus) charge. The negatively charged clay and humus particles act like magnets and attract the plus-charged K to their surfaces to help reduce leaching. However, leaching losses can be a problem on sandy soils or under very high rainfall.
- High K applications can encourage magnesium deficiencies.

The Secondary Macronutrients: Calcium (Ca), Magnesium (Mg), And Sulfur (S)

For most crops, calcium is more important for its role as a liming material (to raise soil pH and lessen acidity) than as a nutrient. Even very acid soils usually have enough calcium to meet the plants' nutrient needs, while soil pH may be too low for good growth. It takes large amounts of calcium to raise the pH compared to those needed for plant nutrition.

Peanuts, however, are an exception and have unusually high calcium needs which usually must be met by supplying gypsum (calcium sulfate.) This is not a liming material.

Magnesium deficiencies are more common than those of calcium and are most likely to occur in sandy, acid soils (usually below pH 5.5) or in response to large applications of K. Too much calcium relative to magnesium also can bring on Mg deficiencies. Farmers who need to lime their soils are usually advised to use dolomitic limestone (about a 50-50 mix of Ca and Mg carbonates). Both calcium and magnesium are slowly leached from the soil by rainfall.

Sulfur deficiencies are not common, but are most likely to occur under these conditions:

- Many volcanic soils tend to be low in available S. Land near industrial areas usually receives enough S from the air.
- Sandy soils and high rainfall
- Use of low sulfur fertilizers (see Table 17). Low analysis fertilizers (those with a relatively low NPK content) generally contain much more S than high analysis fertilizers such as 18-46-0, 0-45-0, etc.

The Micronutrients

Micronutrient deficiencies are much less common than those of N, P, or K, but are most likely to occur under these conditions:

- Highly leached, acid, sandy soils.
- Soil pH above 7.0 (except for molybdenum which is more available at lower pH's).
- Intensively cropped soils fertilized with macronutrients only.
- Areas where vegetables, legumes and fruit trees are grown.
- Organic (peat) soils.

Table 5 Susceptibility of the Reference Crops to Micronutrient Deficiencies

Crop	Most Common Micronutrient Deficiency	Conditions Favoring Deficiency
MAIZE	Zinc	Soil pH above 6.8; sandy soils; high P
SORGHUM	Iron	Soil pH above 6.8; sandy soils; high P
BEANS	Manganese, Zinc	Soil pH above 6.8; sandy soils
	Boron	Acid, sandy soils, pH above 6.8
PEANUTS	Manganese, Boron	Refer to above

Micronutrient Toxicities: Iron, manganese and aluminum can become overly soluble and toxic to plants in very acid soils. Boron and molybdenum can cause toxicities if improperly applied.

Determining fertilizer needs

The amount of nutrients that different crops must absorb from the soil to produce a given yield is fairly well known. Yet proper fertilization is not a simple matter of adding this amount for several reasons:

- The farmer needs to know what share of the nutrients are already in the soil in available form.
- A plant's ability to recover nutrients, whether from fertilizer or natural soil sources, depends on the type of crop, the particular soil's capacity to tie up different nutrients, weather conditions (sunlight, rainfall, temperature), leaching losses, physical soil factors like drainage and compaction, and insect and disease problems.

Likewise, there is no such thing as "tomato fertilizer" or "maize fertilizer", etc. Soils differ so much in natural fertility that no one fertilizer could possibly be right for all types of soil, even for one kind of crop.

When dealing with the reference crops, farmers cannot afford to waste their scarce capital on fertilizers that might be inappropriate for their soils. They also need reasonable guidelines on how much to apply. There are five basic methods used to determine fertilizer needs:

- Soil testing
- Plant tissue testing
- Fertilizer trials
- Spotting visual "hunger signs"
- Making an educated guess

Soil Testing

Soil testing by a reliable laboratory is the most accurate and convenient method for determining fertilizer rates.

Most labs routinely test for available P and K and measure soil pH and exchange capacity (the soil's negative charge). Most do not test for available N, since results are not very accurate.

Some will be able to test for Ca, Mg, S, and some of the micronutrients (micronutrient and S tests vary in reliability).

If the soil is overly acid, the lab will usually be able to tell how much lime the soil will need. Most can test the salinity and alkali hazard of the soil and irrigation water (most common in semi-arid to arid areas).

At the very least, the lab will provide an N-P-K application recommendation for the crop involved. The better labs will tailor the recommendation of the farmer's yield goal and management ability, based on the farmer's responses to a questionnaire supplied by the lab.

Portable soil test kits are not as accurate as laboratory testing but can give a fairly good estimate of soil conditions at a test site. The instructions state within what limits the test kit is accurate.

These kits give results that are as accurate as most farmers will need for growing reference crops. However, if a soil testing laboratory is available farmers should be encouraged to send samples in.

How to Take a Soil Sample

Improper sampling by the farmer or extension worker is the most common cause of faulty lab results. A 200-400 gram sample may represent up to 15,000 tons of soil. The soil laboratory's instructions should be carefully read before sampling. These are usually printed on the sampling box or on a separate sheet. (See Appendix J for general instructions on how, when, and how often to soil test.)

Plant Tissue Tests

The crop can be tissue-tested while growing in the field for N-P-K levels in the sap. Kits cost about US \$20-\$42, but some of the reagents need replacement every year.

Tissue tests are best used to supplement soil test data, since the results can be tricky to interpret by non-professionals. Sometimes plant sap nutrient levels are not well correlated to those in the soil, because weather extremes, insects, and diseases affect uptake. Deficiencies of one nutrient such as N can stunt plant size and cause P and K to "pile up" in the plant sap, giving falsely high readings. The tests are also geared to higher yield levels than most small farmers can reasonably hope to attain. The crops receiving low to moderate fertilizer rates that provide the best return per dollar may show tissue test results indicating deficiencies.

One advantage of tissue testing is that it may be possible to correct a deficiency while the crop is still growing and thus increase yields.

Total Plant Analysis: Some labs can run a total nutrient analysis of plant leaves with a spectrograph, but it may cost US \$10-\$15.

When collecting leaf samples, it is important to pay close attention to the kit's or lab's sampling instructions. Taking leaves from the wrong part of the plant will make results invalid.

Fertilizer Trials

See Chapter 8 and Appendix B.

Spotting Visual "Hunger Signs"

Severe nutrient deficiencies usually produce characteristic changes in plant appearance, particularly in color. Spotting these "hunger signs" can be useful in determining fertilizer needs, but there are several drawbacks:

- Some hunger signs are easily confused with each other or with insect and disease problems. If more than one nutrient is deficient at once, the hunger signs may be too vague for accurate diagnosis.
- Hidden hunger: Hunger signs will not usually appear until the nutrient deficiency is serious enough to cut yields by 30-60 percent or more. This "hidden hunger" can cause unnecessarily low yields even though the crop may look good throughout the growing season.
- It may be too late to correct deficiencies by the time hunger signs appear. Any N applied much beyond flowering time in the cereal crops will increase grain protein more than yields (such protein increases are slight compared to the amount of N used and the yield that is sacrificed by late application). Phosphorus should ideally be placed 7.5-10 cm deep and this is difficult to do without damaging the roots after the crop is up and growing.

Specific hunger signs for the reference crops may be found in Appendix G.

Making an Educated Guess

If no soil test results are available for a farmer's field, a reasonable estimate of N-P-K needs can be made based on at least four or more of the following criteria:

- Available soil test results from nearby farms with the same soil type and a similar liming and fertilizer history.
- Data from fertilizer trials on the same soil type.
- An extension pamphlet on the crop with fertilizer recommendations for the area soils. (Do not rely on their accuracy unless the recommendations are based on soil tests and/or field trial results.)
- The particular crop's relative nutrient needs (discussed later in this section).
- A thorough examination of the soil for depth, drainage, texture, filth, slope, and other factors that may limit yields or fertilizer response, including soil pH.
- Yield history and past management of the farm regarding fertilizer and liming.
- The farmer's management ability, available capital, and willingness to use complementary practices like improved seed, insect control, etc.

Fertilizer types and how to use them

Chemical (inorganic) fertilizers are frequently accused of everything from "poisoning" the soil to producing less tasty and nutritious food. Should the extension worker encourage client farmers to forget about chemical fertilizers and use only organic ones (compost, manure)? The "organic way" is basically very sound, because organic matter (in the form of humus) can add nutrients to the soil and markedly improve soil physical condition (filth, water-holding capacity) and nutrient-holding ability. Unfortunately, some misleading and illusory claims on both sides of the issue cause a lot of confusion.

Chemical fertilizers supply only nutrients and exert no beneficial effects on soil physical condition. Organic fertilizers do both. However, compost and manure are very low-strength fertilizers; 100kg of 10-5-10 chemical fertilizer contains about the same amount of NP-K as 2000 kg of average farm manure. The organic fertilizers need to be applied at very high rates (about 20,000-40,000 kg/ha per year) to make up for their low nutrient content and to supply enough humus to measurably improve soil physical condition.

Overwhelming evidence indicates that chemical and organic fertilizers work best together. A study at the Maryland Agricultural Experiment Station (U.S) showed a 2033 percent yield increase when chemical fertilizers and organic matter were applied together, compared with applying double the amount of either alone.

Most small farmers will not have access to enough manure or other organic matter to cover more than a small portion of their land adequately. When supplies are limited, they should not be spread too thinly and are often most effective on high-value crops (such as vegetables) grown intensively on small plots.

Manure

Fertilizer value: Animal manure is an excellent source of organic matter, but relatively low in nutrients. The actual fertilizer value depends largely on the type of animal, quality of the diet, kind and amount of bedding used, and how the manure is stored and applied. Poultry and sheep manure usually have a

higher nutrient value than horse, pig or cattle manure. Constant exposure to sunlight and rainfall will drastically reduce manure's fertilizer value.

On the average, farm manure contains about 5.0 kg N, 2.5 kg P₂O₅, and 5.0 kg K₂O per metric ton (1000 kg), along with various amounts of the other nutrients. This works out to a 0.5-0.25-0.5 fertilizer formula. (See the chemical fertilizer section for an explanation of how fertilizer ratios are determined if this is confusing.) BUT only about 50 percent of the N, 20 percent of the P, and 50 percent of the K is readily available to plants during the first month or two, because most of the nutrients are in the organic form which first has to be converted to the available inorganic form by soil microbes. This does mean, however, that manure has good residual fertilizer value.

Farm manure is low in phosphorus: It tends to have too little available P in relation to available N and K. If used as the sole source of fertilizer, some experts recommend fortifying it with 25-30 kg of single superphosphate (0-20-0) per 1000 kg of manure. This also helps reduce the loss of N as ammonia. However, it is more convenient and effective to apply chemical fertilizer directly to the soil instead of attempting to mix it with the manure.

Manure as a source of micronutrients: When lives such as pigs and chickens are fed largely on nutritionally-balanced commercial feeds, their manure may be a particularly good source of micronutrients if applied at a high rate. Manure from animals fed mainly on local vegetation is likely to have a lower micronutrient content.

How to store manure: It is best to store it under a roof or in a covered pit, but manure can be stored in piles with steep sides to shed water and good depth to reduce leaching losses by rain.

Guidelines for applying manure:

- Manure is best applied a couple of weeks to a few days before planting. If applied too far in advance, some N may be lost by leaching. To avoid "burning" the crop seeds and seedlings, fresh manure should be applied at least a couple of weeks in advance; rotted manure is unlikely to cause damage.
- Manure containing large amounts of straw may actually cause a temporary N deficiency unless some fertilizer N is added.
- Manure should be plowed, disked or hoed under soon after application. A delay of just one day may cause a 25 percent loss of N as ammonia gas.
- Rates of 20,000-40,000 kg/ha are generally recommended, but limit poultry and sheep manure to about 10,000 kg/ha since it is more likely to cause "burning". This works out to about 2-4 kg/sq. m (1 kg/sq. m for poultry and sheep manure).
- If quantities are limited, farmers are better off using moderate rates over a larger area rather than a high rate on a small area.
- Manure also can be applied in strips or slots centered over the row if farmers are willing to make the extra effort involved. This is a good way to use scarce amounts. Fresh manure may burn seeds or seedlings if not mixed well with the soil.

Compost

As with manure, large amounts are needed to improve soil physical condition or supply meaningful amounts of nutrients. Compost-making takes a tremendous amount of labor and is seldom feasible for anything but small garden plots. (For more information on compost, refer to the PC/ICE Soils, Crops, and Fertilizer Use manual.)

Other Organic Fertilizers

Blood meal and cottonseed meal have much higher N contents than manure and compost, and contain other nutrients as well. However, they are valued as animal feeds and are likely to be too expensive. Bone meal (15-20 percent P_2O_5) makes P available very slowly and is also expensive.

The hulls of rice, cotton-seed, and peanuts have virtually no nutrient value, but can be used as mulches or to loosen up clayey soils on small plots. They may cause a temporary N tie-up.

Green Manure Crops

See Chapter 4.

Chemical fertilizers

Chemical fertilizers (also called "commercial or "inorganic" fertilizers) contain a much higher concentration of nutrients than manure or compost, but lack their soil-improving qualities.

Few farmers will have enough organic fertilizer to cover more than a fraction of their land adequately, so chemical fertilizers are usually an essential ingredient for improving yields quickly. Despite their ever-increasing cost, they can still frequently return good value if correctly used.

Types of Chemical Fertilizers

For soil application, granules are the most commonly used form. They usually contain one or more of the "Big Three" (N, P, K), varying amounts of sulfur and calcium (as carriers), and very low or nonexistent amounts of micronutrients.

The fertilizers can be either simple mechanical mixes of two or more fertilizers or an actual chemical combination with every granule identical in nutrient content.

How to Read a Fertilizer Label

All reputable commercial fertilizers carry a label stating their nutrient content, not only of NP-K, but also of any significant amounts of sulfur, magnesium, and micronutrients.

The Three Number System: This states the content of NP-K in that order, usually in the form of N, P_2O_5 , and K_2O . The numbers always refer to percent. A 12-24-12 fertilizer contains 12 percent N, 24 percent P_2O_5 , and 12 percent K_2O which is the same as 12 kg N, 24 kg P_2O_5 and 12 kg K_2O per 100 kg. A 0-21-1 fertilizer has no nitrogen or potassium, but contains 21 percent P_2O_5 . Here are some more examples:

- 300 kg 16-20-0 contain 48 kg N, 60 kg P_2O_5 0 kg K_2O
- 250 kg 12-18-6 contain 30 kg N, 45 kg P_2O_5 0 kg K_2O

The Fertilizer Ratio

The fertilizer ratio refers to the fertilizer's relative proportions of N, P_2O_5 and K_2O . A 12-24-12 fertilizer has a 1:2:1 ratio and so does 6-12-6; it would take 200 kg of 6-12-6 to supply the same amount of N-P-K as 100 kg of 12-24-12. Both 15-15-15 and 10-10-10 have a 1:1:1 ratio.

N, P_2O_5 , K_2O versus N, P, K: Note that a fertilizer's N content is expressed as N, but that the P and K content is usually expressed as P_2O_5 and K_2O . This system dates back to the advent of chemical fertilizers in the 19th Century and is still used by most countries, although a few have switched to an NP-K basis. A fertilizer recommendation given in terms of "actual P" and "actual K", refers to the new system; check the fertilizer label to see if the nutrient content is given as N- P_2O_5 - K_2O or as N-P-K.

The formulas below show how to convert between the 2 systems:

$$P \times 2.3 = P_2O_5 \quad P_2O_5 \times 0.44 = P$$

$$K \times 1.2 = K_2O \quad K_2O \times 0.83 = K$$

For example, a fertilizer with a 14-14-14 N-P₂O₅-K₂O label would be labeled 14-6.2-11.6 on an N-P-K basis. Likewise, if a fertilizer recommendation calls for applying 20 kg of "actual P" per hectare, it would take 46 kg (i.e. 20 2.3) of P₂O₅ to supply this amount. Table 6 gives the nutrient content of common fertilizers. (Refer to pages 74-78 of PC/ICE'S Soil, Crops and Fertilizer Use manual for more detailed information.)

Basic guidelines for applying chemical fertilizers

Nitrogen

When fertilizing maize, sorghum, and millet, one-third to one-half of the total N should be applied at planting time. This first application will usually be in the form of an N-P or N-P-K fertilizer. The remaining N should be applied in one to two sidedressings (fertilizer applications made along the row while the crop is growing) later in the growing season when the plants' N usage has increased. A straight N fertilizer like urea (45-46 percent N), ammonium sulfate (20-21 percent N) or ammonium nitrate (33-34 percent N) is recommended for sidedressings. When one sidedressing is to be made, it is usually best applied when the crops are about knee-high (25-35 days after plant emergence in warm areas). On very sandy soils or under high rainfall, two sidedressings may be needed and are best applied at the knee-high and flowering stages.

Table 6 Composition of common fertilizers

NITROGEN RESOURCES	N %	P₂O₅ %	K₂O %	S %
Anhydrous ammonia (NH ₃)	82 %	0	0	0
Ammonium nitrate	33 %	0	0	0
Ammonium nitrate with lime	20.5 %	0	0	0
Ammonium sulfate	20-21 %	0	0	23-24 %
Ammonium phosphate sulfate (2 types)	16 %	20 %	0	9-15 %
	13 %	39 %	0	7 %
Mono-ammonium phosphate (2 kinds)	11 %	48 %	0	3-4 %
	12 %	61 %	0	0
Di-ammonium phosphate (3 kinds)	16 %	48 %	0	0
	18 %	46 %	0	0
	21 %	53 %	0	0
Calcium nitrate	15.5 %	0	0	0
Sodium nitrate	16 %	0	0	0
Potassium nitrate	13 %	0	46 %	0
Urea	45-46 %	0	0	0
PHOSPHORUS SOURCES				
Single superphosphate	0	16-22 %	0	8-12 %
Triple superphosphate	0	42-47	0	1-3 %
Mono- & di-ammonium phosphates (see under N)				
Ammonium phosphate sulfate (see under N)				
POTASSIUM SOURCES				
Potassium chloride (muriate of potash)	0	0	62 %	0
Potassium sulfate	0	0	50-53 %	18 %
Potassium nitrate	13 %	0	44 %	0
Potassium magnesium sulfate (11 % Mg, 18 % MgO)	0	0	21-22 %	18 %

NOTE: P₂O₅ x 0.44 = P; K₂O x 0.83 = K; S x 3.0 = SO₄

Where to Place Nitrogen Fertilizer

As an N-P or NP-K Fertilizer: See the section on phosphorus below.

As an N Sidedressing: There is no need to place a straight N fertilizer as deep as with P and K, since rainfall will carry the N downward into the root zone. Work it in 1.0-2.0 cm to keep the fertilizer from being carried away by surface water flow. Urea should always be worked in to avoid loss of N as ammonia gas. (The same is true for all ammonium N fertilizers when soil pH is above 7.0') The best time to sidedress is right before a weeding (cultivation)- the cultivator or hoe can then work it into the soil a bit.

Nitrogen can be placed in a continuous band along the crop row 20 cm or more out from the plants. Crops with spreading root systems like maize, sorghum, and millet can be sidedressed mid-way between the rows with no loss of effect. There is no need to broadcast the N to encourage better distribution, because it will spread outward as it moves downward through the soil. Avoid spilling fertilizer on the crop leaves since it can burn them. (Fertilizer burn occurs when too much fertilizer is deposited too close to the seeds or seedlings, causing them to turn brown and lose ability to absorb water.) If time is short, every other row can be sidedressed with twice the per-row amount.

Phosphorus

Phosphorus is virtually immobile in the soil. This means that fertilizers containing P should be placed at least 7.5-10 cm deep to assure good root uptake. The roots of most crops are not very active close to the soil surface (unless some form of mulching is used) since the soil dries out so readily. For these reasons, all the P fertilizer should be applied at planting time:

- Young seedlings need a high concentration of P in their tissues for good early growth and root development.
- Phosphorus does not leach, so there is no need to make additional sidedressings.
- To be effective as a sidedressing, P would also need to be placed deep (except on a heavily mulched soil), and this might damage the roots.

NOTE: Many farmers waste money by sidedressing with N-P, N-P-K or P fertilizers after already applying P at planting. Others do not apply P until the crop is several weeks old. In either case, crop yields suffer.

How to Minimize Phosphorus Tie-up

Only about 5-20 percent of the fertilizer P that the farmer applies will actually become available to the growing crop. Application method has a big influence on the amount of tie-up that occurs.

In general, farmers should not broadcast fertilizers containing P, even if they plow or hoe them into the ground. Broadcasting maximizes P tie-up by spreading the fertilizer too sparsely and exposing each granule to full soil contact. Broadcasting gives a much better distribution of P throughout the topsoil, but very high rates are needed to overcome tie-up and few small farmers can afford them. In fact, it takes about two to ten times as much broadcast P to produce the same effect as an equal amount of locally placed P. Instead, farmers should use one of the localized placement methods described below. Concentrating the fertilizer in a small area enables it to overcome the tie-up capacity of the immediate surrounding soil.

Adding large amounts of organic matter to the soil helps decrease P tie-up, but usually is not feasible on large fields. Soil pH should be maintained within the 5.5-7.0 range if possible. Very acid soils have an especially high P tie-up capacity. When P is applied as an N-P or N-P-K fertilizer, the N helps increase the uptake of P by the plant roots.

Placement of P Fertilizers

Continuous band method: This is the best method for the reference crops and is especially well suited to closely spaced drill plantings. The optimum location of the band is 5.0-6.0 cm to the side of the seed row and 5.0-7.5 cm below seed level. One band per row is sufficient.

How to make a band: The farmer has a couple of choices:

a. Fertilizer band applicators are available for most models of tractor drawn planters and for some animal-drawn planters. Hand-pushed band applicators are also available commercially. The International Institute for Tropical Agriculture (IITA) farming systems program has designed a hand-pushed model that can be built in any small workshop with welding and metal shearing capabilities. However, it is not clear from the design whether the IITA model actually places the fertilizer below the soil surface.

b. Plow or hoe methods

- The farmer can make a furrow 7.5-15 cm deep with a wooden plow or hoe, apply the fertilizer by hand along the bottom, then kick in enough soil to fill the furrow back up to planting depth. This gives a band of fertilizer running under the seeds and a little to each side. As long as there is 5.0-7.5 cm of soil separating the fertilizer and the seeds, there is little danger of burning.
- A less satisfactory method is to make one furrow at planting depth and place both seed and fertilizer in it together (the furrow should be wide so the fertilizer can be spread out and diluted somewhat). This works with maize at low to medium rates of N and K (no more than 200-250 kg/ha of 16-20-0 or 14-14-14, no more than 100-125 kg/ha of 18-46-0 or 16-48-0). Higher rates may cause fertilizer burn. Beans and sorghum are more sensitive to fertilizer burn than maize.

Half-circle Method: Works well when seeds are planted in groups ("hill planting") spaced relatively far apart on untilled ground where banding would be impractical. The fertilizer is placed in a half circle made with a machete, hoe, or trowel about 7.5-10 cm away from each seed group and 7.5-10 cm deep. This is time-consuming, but gives a better distribution of fertilizer than the hole method.

Hole method: This is the least effective of the three methods, but is much better than using no fertilizer at all. It may be the only feasible method for land that has been hill planted without any prior tillage. Fertilizer is placed in hole 10-15 cm deep and 7.5-10 cm away from each seed group.

Potassium

Potassium ranks midway between N and P in terms of leaching losses. As with P, all the K can usually be applied at planting time, often as part of an N-P-K fertilizer. Where leaching losses are likely to be high (very sandy soils or very high rainfall), split applications of K are sometimes recommended.

Unlike N and P, about two-thirds of the K that plants extract from the soil ends up in the leaves and stalks rather than in the grain. Returning crop residues to the soil is a good way of recycling K. Burning them will not destroy the K, but will result in the loss of their N, sulfur, and organic matter.

Some Special Advice For Furrow-Irrigated Soils

When using the band, half-circle or hole methods on furrow irrigated soils (crops irrigated by conveying water along a furrow between each row or bed) the farmer should be sure to place the fertilizer below the level that the irrigation water will reach in the furrow. Placement below this "high water" mark enables mobile nutrients like nitrate and sulfate to move sideways and downwards toward the roots. If placed above the water line, the upward capillary movement of water will carry these mobile nutrients to the soil surface where they cannot be used. (Upward capillary movement is the same process that enables kerosene to "climb" up the wick in a lamp.)

Determining how much fertilizer to use

The following table can be used to determine how much fertilizer to apply per length of row (if the half-circle or hole method is used). (The formula found in PC/ICE's Soil, Crops and Fertilizer Use manual can also be used to determine this amount.)

NOTE: Rather than tell farmers to apply so many grams or ounces per length of row or per hill, convert the weight dosage to a volume dosage using a commonly available container like a tuna fish or juice can, jar lid or bottle cap.

Fertilizers vary in density, so be sure to determine the weight/ volume relationship for each type using an accurate scale.

Table 7 Determining How Much Fertilizer is Needed per Meter of Row Length or per "Hill"

I. Per Meter of Row Length (For band applications):

Row Width	AMOUNT OF FERTILIZER NEEDED PER HECTARE					
	100 kg	200 kg	300 kg	400 kg	500 kg	600 kg
	GRAMS TO APPLY PER METER OF ROW LENGTH					
50 cm	5	10	15	20	25	30
60 cm	6	12	18	24	30	36
70 cm	7	14	21	28	35	42
80 cm	8	16	24	32	40	48
90 cm	9	18	27	36	45	54
100 cm	10	20	30	40	50	60

II. Per Hill (For half-circle or hole applications): In this case, the amount depends on the row spacing and the distance between hills in the row. The table below shows how many grams of fertilizer are needed per hill to equal a rate of 100 kg/ha. To find out how much would be needed to equal a rate of 250 kg/ha, you would multiply the table's figures by 2.5.

Distance between hills

Row Width	DISTANCE BETWEEN HILLS							
	30 cm	40 cm	50 cm	60 cm	70 cm	80 cm	90 cm	100 cm
	GRAMS OF FERTILIZER NEEDED PER HILL TO EQUAL 100 KG/HA							
50 cm	1.5	2.0	2.5	3.0	3.5	4.0	4.5	5.0
60 cm	1.8	2.4	3.0	3.6	4.2	4.8	5.4	6.0
70 cm	2.1	2.8	3.5	4.2	4.9	5.6	6.3	7.0
80 cm	2.4	3.2	4.0	4.8	5.6	6.4	7.2	8.0
90 cm	2.7	3.6	4.5	5.4	6.3	7.2	8.1	9.0
100 cm	3.0	4.0	5.0	6.0	7.0	8.0	9.0	10.0

Foliar Fertilizers

Foliar applications are best suited for micronutrients: Soluble powder or liquid fertilizers may be sold in some areas for mixing with water and spraying on the leaves. Some granular fertilizers like urea, ammonium nitrate, and di-amonium phosphate are also soluble enough for this purpose. However, only small amounts of fertilizer can be sprayed on the leaves per application without causing "burning" - this means that foliar applications are usually best suited for micronutrients of which very little is needed. Foliar applications are especially useful for applying iron, which becomes readily tied up and unavailable when applied to the soil. Although foliar-applied fertilizers take effect rapidly (within one to three days) they have much less residual value than soil applications.

N-P-K foliar fertilizer are often claimed to produce very profitable yield increases.

- Numerous trials have shown that N-P-K foliar fertilizers usually "green up" the leaves but significant yield increases are unlikely as long as sufficient N-P-K is applied to the soil. A 1976 International Center for Tropical Agriculture (CIAT) trial in Colombia did obtain a 225 kg/ha yield increase on beans by spraying them three times with a 2.4 percent solution (by weight) of mono-ammonium phosphate (11-480) even though 150 kg/ha of P₂O₅ had been added to the soil. (The spray contributed only about 10 kg/ha of P₂O₅.) However, the soil had a very high P tie-up capacity.

The soluble powder and liquid foliar fertilizers are much more expensive per unit of nutrient compared to ordinary granular fertilizers.

Numerous applications are usually needed to supply a meaningful amount of N-P-K through the leaves without risk of burning.

Some N-P-K foliar fertilizers have micronutrients included but the amounts are far too small for preventing or curing deficiencies.

How to Avoid Fertilizer "Burn"

Fertilizer "burn" occurs when too much fertilizer is placed too close to the seeds or seedlings. It is caused by a high concentration of soluble salts around the seed or roots which prevents them from absorbing water. The seeds may germinate poorly from tips downward, the seedling leaves may begin to turn brown, and the plants may die.

Guidelines for Avoiding Fertilizer Burn

- The N and K in fertilizers have a much higher "burning" ability than P. Single and triple superphosphate are very safe. Sodium nitrate and potassium nitrate have the highest burn potential per unit of plant nutrient followed by ammonium sulfate, ammonium nitrate, mono-ammonium phosphate (11-48-0), and potassium chloride. Di-ammonium phosphate (16-48-0, 18-46-0) and urea can injure seeds and seedlings by releasing free ammonia gas. The higher the ratio of N and K to P in an N-P-K fertilizer, the greater the likelihood of burning due to improper placement.
- When using fertilizers containing N, do not place them any closer than 5 cm to the side of the seed row when banding and 7.5 cm when using the half-circle or hole methods (see exceptions discussed under banding methods). There is little danger of burning when sidedressing growing crops with N, but avoid dropping the granules on the leaves.
- Fertilizer burn occurs more frequently on sandy soils than on clayey soils and under low moisture conditions. A heavy rain or irrigation will help carry damaging salts away if burning occurs.

Recommended fertilizer rates for the reference crops

The most profitable rate of fertilizer use for the small farmer depends on management ability, capital available, limiting factors, soil fertility level, type of crop, expected price and cost of fertilizer.

Small farmers should usually aim for maximum return per dollar spent. This means using low to moderate rates of fertilizer because crop yield response is subject to the law of diminishing returns.

Since the efficiency of fertilizer response declines as rates go up, the small farmer with limited capital is usually better off applying low to medium rates of fertilizer. He or she will end up with a higher return per dollar invested, be able to fertilize more land, and have money left over to invest in other complementary yield-improving practices.

As a farmer's capital situation improves, higher rates of fertilizer may be justified as long as investments in other worthwhile practices are not sacrificed. Another factor to consider is that fertilizer can reduce the land and labor needed to produce a given amount of crop, thus cutting costs and allowing for more diversity of production.

Some General Guidelines for Low, Medium and High Rates Of N-P-K

Keeping in mind the many factors that determine optimum fertilizer rates, Table 8 provides a very general guide to LOW, MEDIUM, and HIGH rates of the "Big Three" for the reference crops based on small farmer conditions and using localized placement of P. The "high" rates given here would be considered only low to medium by most farmers in Europe and the U.S. where applications of 200 kg/ha of N are not uncommon on maize and irrigated sorghum.

There are several important qualifications to Table 8:

- YOU MUST CONSIDER THE FERTILITY LEVEL OF THE SOIL as well as the type of crop. A soil high in available K would need little or no fertilizer K. Most cropped soils tend to be low in N and low to medium in P, but K deficiencies are less common. Peanuts often respond better to residual P and K rather than to direct applications.
- Legumes such as peanuts, cowpeas, soybeans, pigeonpeas, mung beans, and chickpeas are very efficient N fixers if properly inoculated with the correct strain of Rhizobia bacteria or if grown on soils with a good natural population of the correct Rhizobia. In some cases, however, a starter application of 15-25 kg/ha of N has given a positive response by feeding the plants until the Rhizobia begin to fix N (about two to three weeks after plant emergence). Such responses are the exception rather than the rule and are most likely to occur on sandy soils.

Beans (Phaseolus vulgaris) are not so efficient at N fixation and can use up to 50-60 kg/ha of N.

- The farmer's management ability is a vital consideration. Farmers should not be encouraged to use a high rate of fertilizer if he or she is not willing or able to use other complementary yield-improving practices.

Table 8 General guidelines for low, medium, and high rates of N-P-K

	LOW (Lbs./acre or kg/hectare)	MEDIUM(Lbs./acre or kg/hectare)	HIGH(Lbs./acre or kg/hectare) ¹
N ₂	35-55	60-90	100+
P ₂ O ₅	25-35	40-60	70+
K ₂ O	30-40	50-70	80+

¹ When inter-converted, lbs./acre and kg/ha are equivalent at least for the purposes of this general table. Kg/ha x 0.89 = lbs./acre.

Fertilizer recommendations for specific crops

Maize

Fertilizer Response

When starting from a low yield base like 1000-1500 kg/ha, yields of shelled maize should increase by roughly 25-50 kg for each kg of N applied up to a yield of around 4000-5000 kg/ha. With higher rates of application, response generally falls below this ratio. Such yield increases will be obtained if:

- Other nutrients like P and K are supplied as needed, soil moisture is adequate, a responsive variety is used, and there are no serious limiting factors such as insects, diseases, weeds, soil ph, drainage, etc.
- The fertilizers are applied correctly and at the right time.

If response falls below the 25-50 level, this means that one or more serious limiting factors is present or that too high an N rate was used. Table 8 can be used as a guide, but soil should be tested whenever possible. Studies have shown that maize can use locally-placed (band, half-circle, hole) P efficiently up to about 50-60 kg/ha of P₂O₅.

Micronutrients: Except for zinc, maize is not very susceptible to micronutrient deficiencies.

Zinc deficiency can be confirmed by spraying about 20 plants with a solution of one tablespoon (15 cc) zinc sulfate in about four liters of water along with about 5 cc of liquid dishwashing detergent as a wetting agent. If zinc is the only nutrient lacking, new leaves will have a normal green color when they emerge.

Table 9

Zinc Source	% Zinc	Amount Needed	Application Method
Zinc sulfate monohydrate	23%	8-12 kg/ha (lbs./acre)	mixed with planting fertilizer and locally placed
Zinc sulfate heptahydrate	35%	6-9 kg/ha (lbs./acre)	mixed with planting fertilizer and locally placed
Zinc oxide	78%	2.5-4 kg/ha (lbs./acre)	mixed with planting fertilizer and locally placed
Zinc sulfate	23%, 35%	350-500 grams/100 liters water plus a wetting agent	Foliar; spray the leaves; may cause leaf burn under some conditions.

Sorghum

Fertilizer Response: Sorghum will give similar fertilizer responses to maize if moisture is adequate and improved varieties are used. As always, farmers should be encouraged to test the soil first rather than rely on general recommendations.

Nutrient needs are similar to those of maize, except that sorghum is most susceptible to iron deficiency.

Iron deficiencies seldom respond well to iron applied in the soil unless special chelated (organic and more costly) forms are used to protect against tie-up. Deficiencies should be treated by spraying the plants with a solution of 2-2.5 kg of ferrous sulfate dissolved in 100 liters of water along with sufficient wetting agent to assure uniform leaf coverage. Begin spraying as soon as symptoms appear; the plant may need several applications during the growing season on severely deficient soils.

Sorghum seeds and seedlings are more sensitive to fertilizer burn than maize. If more than one grain harvest is to be taken from one planting, all the P and K should be applied at planting along with about 30-50 kg/ha of N. Another dressing of 30-50 kg/ha of N should be applied about 30 days later. After the first harvest, apply an additional 30-50 kg/ha 25-30 days later.

Millet

Fertilizer Response: Low soil moisture is a major factor limiting fertilizer response. Traditional varieties are usually less responsive. Studies in India by ICRISAT showed that improved pearl millet varieties were responsive to N rates as high as 160 kg/hectare under adequate moisture, but that traditional types seldom responded well above the 4080 kg/hectare range. The N-P-K rates in Table 8 can be used as a guide, taking into consideration the moisture and variety factors.

Peanuts

Fertilizer Response: Peanuts tend to give rather unpredictable responses to fertilizer and offer respond best to residual fertility from previous applications to other crops in the rotation.

Nitrogen and Nodulation: If the right strain of Rhizobia bacteria is present, peanuts can ordinarily satisfy their own N requirements. There are two exceptions:

- If poorly drained portions of the field become waterlogged temporarily, the Rhizobia may die off and the plants begin to turn yellow. An application of 20-40 kg/ha of N may be needed to carry the plants through until the bacteria become reestablished in several weeks.
- In some cases (mainly on light-colored, sandy soils), 20-30 kg/ ha of N applied at planting has seemed to help the plants establish themselves until the Rhizobia begin to fix N about three weeks after emergence. This is not widely recommended.

To check for proper nodulation, carefully remove the roots of plants at least three weeks old and look for clusters of fleshy nodules (up to the size of small peas) especially around the tap root. Slice a few open - if they are reddish inside, this shows they are actively fixing N.

Seed inoculation is normally not necessary if peanuts are sown on land that has grown peanuts, cowpeas, lima beans, mung beans or crotalaria within the past three years. Commercial inoculant is a dark-colored, dried powder which contains the living Rhizobia and comes in a sealed packet. Seed is placed in a basin and moistened with water to help the inoculant stick (adding a bit of molasses helps, too). The correct amount of inoculant is mixed with the seed, and planted within a few hours. Exposing the seed to sunlight can kill the bacteria.

Phosphorus and Potassium: Because peanuts have an unusually good ability to utilize residual fertilizer from preceding crops, they do not respond well to direct applications of P and K unless levels are very low. In fact, there is good evidence that high K levels in the podding zone can increase the number of pops (unfilled kernels) due to decreased calcium availability.

Calcium: Peanuts are one of the few crops having a high Ca requirement. Light green plants plus a high percentage of pops may indicate Ca hunger. Calcium does not move from the plant to thepods; rather, each pod has to absorb its own requirement. Gypsum (calcium sulfate) is used to supply Ca to peanuts because it is much more soluble than lime and has no effect on soil pH (using lime to supply Ca can easily raise the pH too much). The usual application where deficiencies exist is 600-800 kg/ ha of dry gypsum applied right over the center of the crop row (it will not "burn") in a band 40-45 cm wide any time from planting until flowering.

Gypsum also supplies sulfur.

Micronutrients: Boron and manganese are the ones most likely to be deficient (see Table 5). Boron can be toxic if applied at rates much above those given in Table 10 especially when banded.

Table 10 Suggested Boron (B) and Manganese (MN) Rates For Peanuts on Deficient Soils

Material	% B or Mn	Amount Needed	How Applied
Borax	11% B	5-10 kg/ha	Mixed with fungicide dusts for leafspot or mixed with gypsum. Do not locally place boron or injury may result.
Solubor	20% B	2.75 kg/ha	Spray plants
Manganese sulfate	26-28% Mn	15-20 kg/ha	Banded with row fertilizer at planting
Soluble manganese sulfate	26-28% Mn	5 kg/ha	Spray on plant leaves; use wetting agent.
Manganese sulfate	26-28% Mn	15 kg/ha	Dust the plants with the finely ground form

Beans (Kidney Beans)

Nitrogen: Beans are less efficient N fixers than peanuts or cowpeas and recommended N rates usually fall in the range of 40-80 kg/ha N. In a 1974 CIAT trial in Colombia, 40 kg/ha N increased yields to 1450 kg/ha compared to 960 kg/ha with no N. It was found that acid forming fertilizer N sources such as urea and ammonium sulfate could increase the chances of aluminum and manganese toxicity if banded near the row on very acid soils. It was recommended that the N be spread out more in these cases.

Phosphorus: Beans have a high P requirement, and this is often the major limiting nutrient, especially on soils with a high capacity to tie up P. A 1974 CIAT trial on such a soil resulted in yields of 700 kg/ha without P and 1800 kg/ha when 200 kg/ha of P₂O₅ was banded along the row. Such high rates of P may be needed on soils with serious P tie-up problems. Under such conditions, it might take 10 times this amount to give the same effect if broadcast.

Potassium deficiencies are uncommon in beans.

Magnesium deficiency may occur in very acid soils or those high in Ca and K. It can be controlled by applying 100-200 kg/ha of magnesium sulfate or 20-30 kg/ha of magnesium oxide to the soil. If the soil needs liming, using dolomitic limestone (20-45 percent Mg) will solve the problem. Dolomitic limestone and magnesium oxide should be broadcast and plowed or hoed under before planting. Magnesium sulfate (Epsom salts) can be band-applied or sidedressed. A foliar application of one kg magnesium sulfate per 100 liters water can be tried on established crops.

Micronutrients: Beans are most susceptible to manganese, zinc, and boron deficiencies (see Table 5). Varieties differ in their susceptibilities.

Zinc rates: As for maize.

Manganese: As for peanuts.

Boron: 10 kg/ha of borax banded with the row fertilizer at planting or 1 kg Solubor (20 percent B) per 100 liters of water sprayed on plants.

Manganese toxicity is sometimes a problem on very acid soils, especially if they are poorly drained. Symptoms are easily confused with those of zinc and magnesium deficiency. Beans are also very sensitive to aluminum toxicity which occurs below a pH of 5.2-5.5, and liming the soil is the only control. If aluminum toxicity is severe, plants may die shortly after emergence. In more moderate cases, the lower leaves become uniformly yellow with dead margins, the plants become stunted, and yields can be lowered dramatically.

Cowpeas

Well-nodulated cowpeas do not respond to N applications, although a starter dosage of 10 kg/ha N sometimes shows results.

Liming

Soils with a pH below 5.0-5.5 (depending on the soil) can adversely affect crop growth in four ways:

- Aluminum, manganese, and iron toxicities: These three elements increase in solubility as soil pH drops and may actually become toxic to plants at pH's below 5.0-5.5. Beans are especially sensitive to aluminum toxicity which is the crop's biggest yield limiting factor in some areas. Many soils labs routinely test for soluble aluminum levels in very acid samples. Manganese and iron toxicities can be serious, too, but usually are not a problem unless the soil is also poorly drained.
- Very acid soils are usually low in available P and have a high capacity to tie up added P by forming insoluble compounds with iron and aluminum.
- Although very acid soils usually have enough calcium to supply plant needs (except for peanuts), they are likely to be low in magnesium and available sulfur and molybdenum.

- Low soil pH depresses the activities of many beneficial soil microbes such as those that convert unavailable N, P, and S to available mineral forms.

Maize and cowpeas may tolerate soil acidity in the pH 5.0-5.5 range depending on the soil's soluble aluminum content. Sorghum is somewhat more tolerant than maize to soil acidity. Peanuts commonly do well down to pH 4.8-5.0 since they have comparatively good aluminum tolerance. Beans are the most sensitive of the reference crops to soil acidity, and yields usually decline below a soil pH of 5.3-5.5.

Where are Acid Soils Likely To be Found?

Soils in higher rainfall areas are likely to be slightly acid to strongly acid since a good deal of calcium and magnesium may have been leached out over time by rainfall. Those of drier regions are likely to be alkaline or only slightly acid due to less leaching.

Continual use of nitrogen fertilizers, whether chemical or organic will eventually lower soil pH enough to require liming. Calcium nitrate, potassium nitrate, and sodium nitrate are the only exceptions and are usually too expensive or unavailable.

How to Tell if Liming is Needed

Soil pH can be measured fairly accurately right in the field with a liquid indicator kit or a portable electric tester. These are useful for troubleshooting but have two drawbacks:

- Soil pH is not the sole criteria for determining if liming is needed. The soil's content of soluble aluminum (called "exchangeable" aluminum) is probably even more important, and the portable pH kits cannot measure this. A soil with a pH of 5.0 or even lower might still be satisfactory for the growth of most crops if its exchangeable aluminum content is low. On the other hand, another soil with a pH of 5.3 might need liming because of too much aluminum. Only the soils lab can tell for sure.
- The amount of lime needed to raise soil pH one unit varies greatly with the type of soil involved. One soil may require 810 times more lime than another to achieve the same rise in pH even though both have the same initial pH. The amount of lime needed depends on the soil's amount of negative charge which varies with its texture, type of clay minerals, and amount of humus. Only the soils lab can determine this.

Calculating the Amount of Lime Needed

Whether using the lab's or other recommendations, adjustments still must be made for the fineness, purity, and neutralizing value of the material used:

- Neutralizing value: On a more pure basis, here are the neutralizing values of four liming materials:

Material	Neutralizing Value (compared to limestone)
Limestone (calcium carbonate)	100 percent
Dolomitic limestone (Ca + Mg carbonate)	109 percent
Hydrated lime (calcium hydroxide)	136 percent
Burned lime (calcium oxide)	179 percent

This means that 2000 kg of burned lime has about the same effect on pH as 3580 kg of limestone of equal purity (2000 kg x 1.79 = 3580 kg).

- Fineness of material greatly affects the speed of its reaction with the soil. Even finely ground material may take two to six months to affect soil pH.
- Purity: Unless the material has a label guarantee, it is difficult to judge purity without a lab analysis.

How, When, and How Often To Lime

- Lime should be broadcast uniformly over the soil and then thoroughly mixed into the top 15-20 cm by plowing or hoeing. Harrowing alone will only move the material down about half this distance. A disk plow or moldboard plow should be used, not a wooden or chisel plow. If spreading lime by hand, the amount should be divided in half and one portion applied lengthwise and the other widthwise. Wear a mask hydrated (slaked) lime and burned lime can cause severe burns.
- Whenever possible, a dolomitic form of liming material should be used to avoid creating a magnesium deficiency.
- Liming materials should be applied at least two to six months ahead of planting, especially if the material is not well ground.
- Liming may be needed every two to five years on some soils, especially if high rates of nitrogen fertilizers, manure or compost are used. Sandy soils will need more frequent liming than clayey soils since they have less buffering capacity, but sandy soils also will require lower rates.

DO NOT OVERLIME!

- Never raise the pH of soil above 6.5 when liming.
- Never raise the pH by more than one full unit at a time (i.e. from 4.6 to 4.6, etc.). It is only necessary to raise the pH up to 5.5-6.0 for good yields of an aluminum sensitive crop like beans.

Overliming can be worse than not liming at all for several reasons:

- Raising the pH above 6.5 increases the likelihood of micronutrient deficiencies, especially iron, manganese, and zinc; molybdenum is an exception.
- Phosphorus availability starts declining once pH rises much above 6.5 due to the formation of relatively insoluble calcium and magnesium compounds.
- Liming stimulates the activity of soil microbes and increases the loss of soil organic matter by decomposition.

Water management

Water Needs of The Reference Crops

Relative Differences: Millet has the best drought resistance of the three cereals, followed by sorghum, and then maize. Of the pulses, cowpeas and peanuts are superior to common beans in this respect.

Critical Water Demand Periods: The critical water demand period for all the reference crops in terms of both yield effect and maximum usage occurs from flowering time through the soft-dough grain stage. Under low humidity and high heat, total water usage (soil evaporation and plant transpiration) may reach 9-10 mm per day during flowering and early grain filling.

Effect of Moisture Stress on Yields: Crops can often overcome the effects of moisture stress occurring early in the season, but yields can be markedly lowered if it occurs during flowering and grain filling. With maize one to two days of wilting during tasseling time can lower yields by up to 22 percent and six to eight days by 50 percent.

Symptoms of Moisture Stress

- Maize, sorghum, and millet will begin to roll their leaves up lengthwise, and the plants will turn a bluish green color. The lower leaves will often dry up and die. (This is referred to as "firing" and is really a drought-induced nitrogen deficiency.)
- The pulse crops will also turn a bluish-green and their leaves will wilt as stress increases. "Firing" may also occur.

Factors Influencing the Likelihood of Moisture Stress:

- Rainfall pattern and quantity: See the section on rainfall in Chapter 2.
- Soil texture: This has a big influence on a soil's water storage capacity. Clay loams and clay soils can hold twice as much available water per foot of depth as sandy soils.
- Soil Depth: Deep soils can store more water than shallow soils and allow greater rooting depth for utilizing it.
- Soil Slope: Much water can be lost by runoff on sloping soils.
- Temperature, Humidity, and Wind: The higher the temperature and wind and the lower the humidity, the greater the rate of crop moisture use and soil evaporation losses.

Keeping Rainfall Records

Since rainfall amount and distribution have such a great effect on crop yields, it is very useful to keep rainfall records at various locations in your work area. The more progressive client farmers should be encouraged to keep their own records.

Judging Rainfall: Showers that produce less than 6 mm usually contribute little moisture to the crop since they do not penetrate the soil very deeply and are quickly evaporated. For example, 5 mm of rainfall will penetrate only about 20 mm into a dry clayey soil and 40 mm into a dry sandy soil.

Improving Water Use Efficiency

In areas with short rainy seasons, the use of early maturing varieties is a valuable tactic.

Planting dates should be timed so that likely moisture stress periods do not coincide with critical crop stages such as pollination.

One study in Kenya showed a yield decrease of 5-6 percent for each day's delay in maize planting after the start of the rains (in an area with a short season). In areas having wet seasons of adequate length, but with periods of moisture stress, some extension services recommend planting two or more varieties with different maturities to lower the risk of total crop failure.

On sloping soils, soil conservation measures such as terracing or ditch-and-bank systems will significantly improve water retention in addition to reducing soil losses.

Weed control both during and between crops will cut water use. In semiarid areas such as the Sahel, deep plowing should be avoided if the subsoil is moist. Fertilizer use will increase moisture use efficiency by encouraging deeper rooting. However, crops cannot utilize as much fertilizer (especially N) when water is a limiting factor.

Optimum plant populations are usually lower under conditions of low rainfall and probable moisture stress.

Mulching the soil surface with a 5.0-7.5 mm layer of crop residues can substantially increase yields in drier areas.

Guidelines for Improving Water Use Efficiency Under Furrow Irrigation

To avoid falling behind in crop irrigation needs, the soil should be pre-irrigated to the full depth of maximum expected root development before planting the crop. Moisture stored in the subsoil is usually safe from evaporation losses unless the soil cracks upon drying. Leaching losses will be negligible if the correct amount is applied since only excess water moves downward by the force of gravity - the rest is held by the soil pores.

Frequent, shallow irrigation should be avoided since it increases evaporation losses and limits the depth of root growth. Shallow irrigation encourages the buildup of harmful salts in dry climates, and frequent irrigation favors the spread of fungal and bacterial diseases. However, irrigation may have to be fairly frequent in the initial stages of crop growth until the plants have been able to put their roots down sufficiently.

6. Pest and disease control

Weed control

How Weeds Lower Crop Yields

Numerous trials in the U.S. have shown maize yield losses ranging from 41-86 percent when weeds were not controlled. One trial in Kenya yielded only 370 kg/ha of maize with no weed control compared to 3000 kg/ha for clean, weeded plots. A CIAT trial with beans in Colombia showed a yield drop of 83 percent with no weeding.

Of course, all farmers weed their fields to some extent, but most of them could significantly increase their crop yields if they did a more thorough and timely job. A University of Illinois (U.S.) trial showed that just one pigweed every meter along the row reduced maize yields by 440 kg/ha. By the time weeds are only a few inches tall, they have already affected crop yields. Weeds lower crop yields in several ways:

- They compete with the crop for water, sunlight, and nutrients.
- They harbor insects, and some weeds are hosts for crop disease. (especially viruses).
- Heavy infestations can seriously interfere with machine harvesting.
- A few weeds like Striga (witch-weed) are parasitic and cause yellowing, wilting, and loss of crop vigor.

Relative competitive ability of the reference crops: Slow starters like peanuts, millet, and sorghum compete poorly with weeds during the first few weeks of growth. Low growing crops like peanuts, bush beans, and bush cowpeas, however, are fairly effective at suppressing further weed growth once they are big enough to fully shade the inter-row spaces. However, tall-growing weeds that were not adequately controlled earlier can easily overtake the "short" crops if allowed to continue growing.

Some Important Facts on Weeds

Broadleaf versus Grassy Weeds

Broadleaf weeds have wide (broad or oval-shaped) leaves with veins that form a feather-like pattern. Grassy weeds are true grasses and have long, narrow leaves with veins that run up and down in a parallel pattern. A few weeds like nutsedge (nutgrass) belong to neither category, but are sedges, all of which have triangular stems. Some chemical herbicides are more effective on broadleaf weeds, while others give better control of grassy types.

How Weeds Reproduce and Spread: Annual versus Perennials

Annual weeds live only a year or so and reproduce by seed; they are the most common weeds in many fields. In the tropics, annuals may live more than a year if rainfall is sufficient. Most annuals produce tremendous amounts of seed, some of which may not germinate for years.

Rough Pigweed, Redroot (*Amaranthus retroflexus*) An example of an annual broadleaf weed; reproduction is by seed.



Yellow Nutgrass (*Cyperus esculentus*) An example of a sedge-type weed. The main stems of sedges are triangular in shape. This particular type reproduces by seed as well as producing underground "nuts," which sprout into new plants.



Bermuda Grass, Devilgrass (*Cynodon dactylon*) An example of a perennial grassy weed; reproduction is by above-ground runners called stolons as well as by seeds.

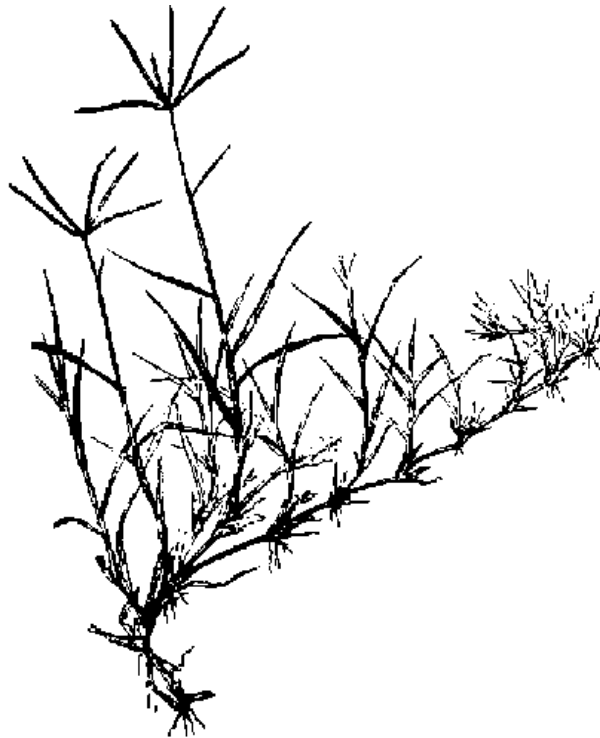

When the soil is stirred with a hoe, harrow, or cultivator to kill weeds, one crop of them is destroyed, but more weed seeds are brought closer to the surface where they can sprout.

Annual weeds should be controlled before they produce seed. Even so, permanent eradication of annual weeds is not possible because most fields contain millions of weed seeds waiting to germinate, and the supply is continually replenished with more seeds brought in by wind, water, animals, animal manure, and contaminated crop seeds.

Perennial weeds live more than two years. Most produce seed, but many also propagate by means of creeping, aboveground stems (stolons), and creeping underground stems (rhizomes). Hoeing or mechanical cultivation may actually aid in spreading them around the field.

Many herbicides will kill only the topgrowth, and there is usually enough food in the underground parts to continue propagation.

Identifying Weeds

Where weeds are being controlled by hoeing or mechanical cultivation, their specific identification is usually not important. Where chemical weed control is used, however, the farmer and extension worker should have a good idea of which specific weeds are present since herbicides do not give broad-spectrum control. (See bibliography for sources of further information on weed identification.)

Weed Control Methods

Burning

When land is cleared by burning, standing annual weeds are killed along with weed seeds very near the soil surface. However, burning will not kill weed seeds or reproductive underground parts of perennial weeds if they are deeper than 4-5 cm. Furthermore, as the brush is often placed in windrows or piles before burning, much of the soil may not be affected by the fire. Some perennial tropical grasses such as Guinea (Panicum maximum) and speargrass (Imperata cylindrica) are actually stimulated into dense regrowth by burning. On the other hand, weeds may be less of a problem under slash and burn farming,

because the soil is usually not turned by plowing or cultivation which brings more weed seeds to the soil surface.

Mulching

Mulching the soil surface with a 5-10 cm layer of crop residues, dead weeds or grass can give very effective weed control and provide a number of other benefits:

- Erosion is greatly reduced on sloping soils.
- Soil water loss by evaporation and runoff is greatly reduced.
- In very hot areas, soil temperatures are reduced to a more beneficial level for crop growth.
- Organic matter is eventually added to the soil. In trials conducted by IITA in Nigeria, mulching increased maize yields by 23-45 percent and greatly reduced the heavy labor requirement for hand weeding which accounts for 50-70 percent of the hours needed to grow maize in that area.

Shading (The Row Crop Principle)

Arranging crops in rows facilitates hand weeding, but also makes possible mechanical cultivation (weeding) with tractor or animal-drawn equipment. In addition, the rows permit the crop to exert better shade competition against the weeds.

Hoe and Machete Cultivation

Weeding with hand tools is an effective method if sufficient labor is available. It is common, however, for small farmers who rely on this method to fall behind in weeding and crop yields often suffer.

Animal and Tractor-drawn Cultivation

Disk harrows, field cultivators, and spike-tooth harrows can provide excellent preplanting weed control. The spike-tooth harrow can also be used to control emerging weeds until the crop is about 7.5-10 cm tall, without serious damage.

Animal-and tractor-drawn row cultivators can be used from the time the crop is a few centimeters tall.. They are faster than weeding by hand, and a one-row animal-drawn model can easily cover 3-4 ha/day unless the rows are very narrow. They can also be adjusted to throw soil into the row itself to kill small weeds by burying them. If operated too deeply or too close to the row, however, serious root pruning (cutting off crop roots during cultivation between rows) may result.

Herbicides

Herbicides can greatly reduce labor requirements and permit a farmer to grow a larger acreage. They also avoid root pruning, soil compaction, and stand reduction which are caused by hand tools or mechanical equipment. In a number of cases, herbicides like atrazine have proven competitive with hand labor in maize production in developing countries. Improved methods for small farmer application of herbicides such as granular forms and ultra low volume sprayers are being developed by IITA. Herbicides do have some very definite disadvantages that must be considered when working with small farmers:

- They are less reliable than hand tool or mechanical weeding and most require careful and accurate application. This can be achieved by small farmers using backpack sprayers, but it requires some training.
- Weed control is seldom complete. Most herbicides are not broad-spectrum, and it is important to analyze the type of local weeds species present before choosing a product.
- Most soil applied herbicides require a certain amount of rain within a week after application in order to move the chemical into the zone of weed seed germination. Others need immediate incorporation into the soil with a disk harrow or rototiller.

- Improper application may damage the crop.
- Nearly all herbicides are unsuited for use in intercropping involving cereals and legumes due to the danger of crop injury. These products are crop-specific as well as weed-specific.
- Without proper training and care, farmers may subject themselves and the environment to serious risks through the misapplication or mishandling of these toxic chemicals.

Guidelines for Non-Chemical Weed Control in the Reference Crops

Pre-planting Weed Control

Successful weed control begins with planting the crop in a seedbed free of standing or emerging weeds. This means that when planting on tilled ground (as opposed to pure slash and burn agriculture), the field should undergo some form of cultivation (i.e. plowing, harrowing, hoeing, etc.) as close as possible to planting. This will give the young seedlings a "head start" on future weeds which is especially important under two conditions:

- Slow starters like sorghum, millet, and peanuts: They are very vulnerable to early season weed competition.
- Reliance on tractor or animal-drawn row cultivation: The only way these cultivators can control weeds in the crop row is by throwing in soil to bury them. This means waiting until the crop is tall enough (usually over 5 cm) so that it will not be buried too. The problem is that weeds already present or about to emerge in the row at planting may be able to grow tall enough to escape burial by the time cultivators can be used.

Frequent pre-plant harrowings do little to reduce the field's potential weed population and they can increase soil compaction and destroy good filth by speeding up the loss of organic matter.

How to Use a Spike-Tooth Harrow on Young or Emerging Seedlings

If large numbers of weeds emerge at the same time as the crop, a shallow working of the entire soil surface (including the rows themselves) with a spike-tooth (pegtooth) harrow may be the best solution if hand weeding labor is inadequate or too expensive. This method is best suited to crops planted at least 40-50 cm deep and can be used any time from two to three days after planting until the crop is 7.5-10 cm tall.

Peanuts and beans, with their brittle stems, are more likely to be injured than maize and sorghum, unless certain precautions are taken (see below). Millet is usually planted too shallowly to tolerate this method well.

Guidelines for using the spike-tooth harrow for this type of weeding:

- The weeds should be either just emerging from the soil or still very small.
- If the soil is very wet and the weather is cloudy, the weeds may be transplanted instead of killed.
- The harrow should be run only deep enough to uproot the tiny weed seedlings.
- Beans and peanuts are more easily injured when they first emerge and still have the crook (bend) in the stem.
- Less injury is likely if the harrow is used in the afternoon when the plants are less turgid (hard) and brittle.

- Care must be taken to ensure that the draft animal or the tractor tires do not run over the row itself.

Using the spike-tooth harrow in this manner once or twice can often eliminate future, more laborious weeding. Use of this harrow prior to plant emergence is also useful for breaking up any soil crusting that might hinder emergence. (For more information on the spike-tooth harrow, see the PC/ICE Animal Traction manual.)

Guidelines for Animal-and Tractor-Drawn Row Cultivators

Animal-drawn cultivators are widely manufactured in one-row models and cost about \$100-\$200 in U.S. currency. They are well worth the investment since they permit more timely and rapid weeding than is possible with hand tools. A one-row cultivator can easily weed 2-3 hectares per day of wide row crops such as maize, millet, and sorghum. Animal-drawn models are available either as single-purpose units or as multi-purpose toolbar frames with attachments for plowing, ridging, and cultivating.

Tractor-drawn cultivators usually consist of a toolbar to which cultivating shanks are attached. Two-row, four-row, six-row, and eight-row arrangements are most common. It is important to remember that such multi-row arrangements require uniform spacing of the planting rows to avoid crop injury.

Cultivator Shovels and Sweeps: Both animal- and tractor-drawn cultivators use sweeps and/or shovels attached to the cultivator shanks to do the actual weeding. Some important considerations:

- Shovels require deeper soil penetration for good weed control and throw more soil than most sweeps. This means that in the case of tractor usage, shovels cannot be operated as close to the crop rows as fast as most sweeps.
- Sweeps are available in widths up to about 50 cm. However the farmer is usually better off using two or more sweeps of smaller widths or a combination of sweeps and shovels to cover one inter-row space. This permits more effective weeding and more accurate adjustment than is usually possible with just one wide sweep. Wide sweeps are also more prone to breakage.

An animal-drawn cultivator which can be adjusted for width by moving the upright level.

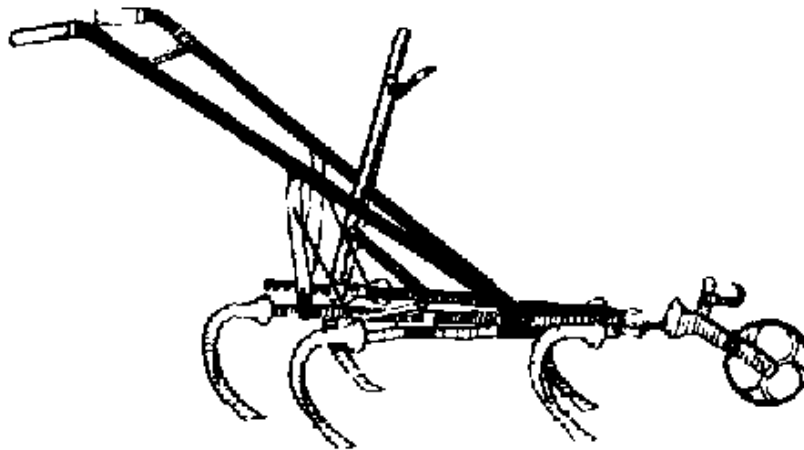

Some General Guidelines for Weeding with Row Cultivators

1. A sure sign of root pruning is the accumulation of crop roots on the cultivator shanks.

To avoid serious root pruning, shovels and sweeps should be operated as shallowly and as far from the crop row as practical. The ideal depth and distance will vary with crop size and row width. For example, when maize is 20 cm tall, it can be cultivated up to 10-15 cm from the stalks. However, once the crop is 75 cm tall, such deep cultivation would prune off much of the root systems. Maximum depth

should be about 5.0-7.5 cm at this stage. Sweeps can be run shallower and closer to the row than shovels and do a good job of weeding without root damage.

2. Sweeps should be set to operate almost flat with the tips angled just slightly downward. When the point rests on a floor or the ground, the outside tips of the wings should rest about 30-60 cm off the surface.

3. Weeds should be killed early to avoid yield losses and to permit more effective control, especially of weeds right in the row.

4. The nitrogen sidedressing is best applied right before a cultivation, then the fertilizer can be worked into the ground a bit to prevent losses through water runoff or through conversion into ammonia gas (a problem with urea).

5. Cultivation is most effective when the soil surface is dry; wet soil keeps partially uprooted weeds alive.

6. The cultivator should be adjusted so that it throws sufficient soil into the crop row to bury small weeds without smothering the crop. **DO NOT THROW SOIL INTO PEANUT ROWS**

7. Unnecessary cultivation can harm the crop. The main purpose of cultivation is to control weeds, although it is sometimes used to break up a hard soil crust that is interfering with water absorption. Excessive cultivation damages plants and roots, wastes time and labor, and increases soil compaction and loss of humus.

A tractor-drawn cultivator weeding beans. This particular model is mid-mounted, which allows the driver to view the weeding operation without having to turn around. Note the two outside shanks on the rear toolbar which help loosen the soil compacted by the tractor tires.



Different types of cultivator shovel; note that some have reversible points.

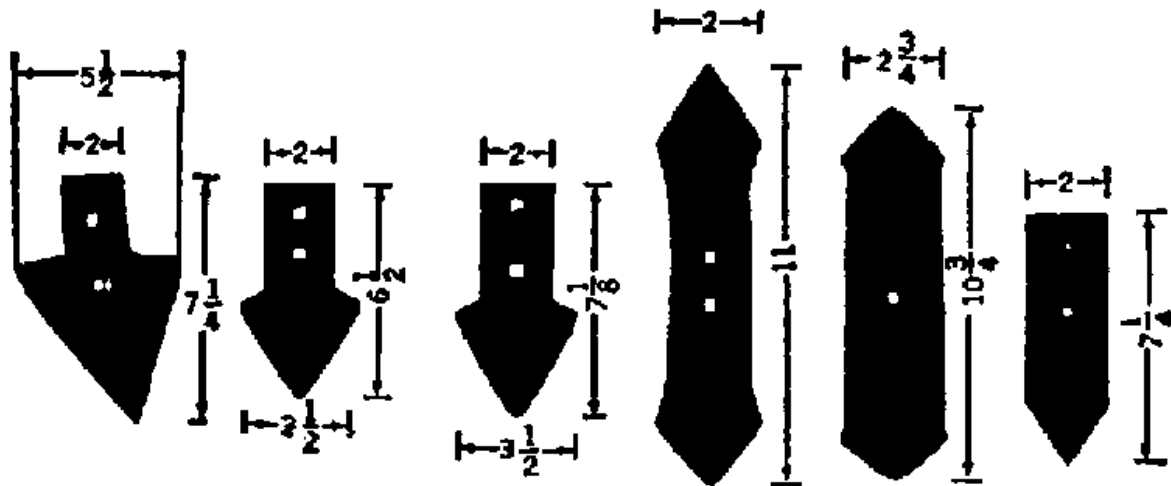

Different types of sweep. They come in many widths. The height of the sweep's crown determines how much soil it throws. The half-sweeps are used next to the crop row to help avoid damage.



Guidelines for Cultivating Reference Crops

MAIZE AND SORGHUM: In many regions, these two crops are commonly "hilled up" during successive cultivations to provide better drainage and to help prevent lodging.

BEANS: Throwing soil into the plant row not only controls small weeds and provides better drainage (good for root rot control), but also helps promote the growth of secondary roots. This is especially beneficial in cases where the primary root system has been damaged by root rot. Do not cultivate beans while the leaves are wet since this increases the spread of foliar diseases like bacterial blight and anthracnose.

PEANUTS: Soil should not be thrown into the crop row, especially when the peanut plants are young. This practice injures the stems and buries some of the young branches which greatly increases the plants' susceptibility to Southern stem rot (Sclerotium rolfsii) and also interferes with normal branch development. There is no need to throw soil into the row if early season weed control is adequate.

"Flat" cultivation will avoid throwing soil into the row. The secret of flat cultivation is good early-season weed control to prevent weeds in the row from overtaking the crop. Most farmers in the U.S. use herbicides to provide initial control for the first six to eight weeks. If using tractor cultivators, farmers should use "high speed" sweeps which have a low crown and do not throw as much soil. Wide sweeps enable the cultivator shanks to be kept well away from the row since they, too, throw a lot of soil.

Cultivation should cease once the pegs begin to elongate, around eight weeks after plant emergence. Cultivation at this stage can damage the pegs and help spread rosette virus, a serious problem in Africa. By this stage, the plants should be big enough to provide good competition with any emerging weeds.

A Special Note on Striga

Striga (witchweed) is a parasitic annual weed which invades the roots of grass family plants (sorghum, maize, millet) and can cause serious losses. There are several species found in Africa, India, Southeast Asia, Australia, and the Southeastern U.S. In West Africa, improved varieties of sorghum are sometimes heavily attacked. Improved maize varieties are somewhat less susceptible but native varieties have better resistance. Gero type millet usually escapes injury since it is harvested during the wet season when striga seeds are dormant. Maiwa millets, which mature later, are more prone to attack.

Striga seeds are stimulated to germinate by moisture and plant juices (root excretions) from the roots of grass family host plants and emerge above ground in about one to two months. Flowering occurs three to four weeks later, and the seeds mature in another 30 days. A single plant can produce half a million seeds which are easily spread by wind, water, and tools. Crops are often injured before the weed emerges, and severe attacks cause stunting, yellowing, and wilting.

Striga Control Recommendations

- Hand weeding provides partial control; some herbicides give good control, and one foliar product has been developed that can be applied with an inexpensive water pistol.
- High fertility helps plants resist attacks, and plant breeders are working on varietal resistance.
- An effort should be made to prevent movement of striga seed from infested to noninfested fields.
- All crops should be kept free of grassy weeds which are hosts for striga.
- "Trap" crops of cereals or grasses can be planted to stimulate striga germination and then plowed under before the weeds have produced seeds.

Guidelines for The Use of Herbicides in the Reference Crops

In some parts of the developing world, there is a critical labor shortage at weeding time. Herbicides can be economically feasible for small farmers under these conditions. In Central America, herbicide use by small farmers has become common in many districts. Chemical weed control is a sophisticated management practice, however, and most farmers using herbicides need more instruction in proper application procedures.

How Herbicides Kill Weeds

Some herbicides like glyphosate will kill weeds only if sprayed on their leaves. Others like simazine will not control emerged weeds, but must be applied to the soil itself where weeds are killed as they germinate by absorbing the chemical through their roots. Some herbicides like atrazine are effective either way.

Choosing a Herbicide

The choice of a suitable herbicide depends on the type of weeds present and the crop's tolerance to the chemical.

Weed Selectivity: Some herbicides control grassy weeds better, some are more effective on broadleaf types, and still others will control some of each. Nearly all herbicides are much more effective on annual weeds than perennial weeds. It is important to remember that individual herbicides seldom provide a full range of weed control and that the specific weed species must be considered when choosing a product to control it.

Crop Tolerance: Each crop may tolerate certain herbicides, but at the same time, be severely injured or killed by others. For example, atrazine will kill most annual grassy and broadleaf weeds on maize, sorghum, and millet without injury to the crop. The herbicide 2, 4D can also be sprayed directly on maize, sorghum, millet, and other grass family crops to control broadleaf weeds without injury to these crops

(unless applied too heavily or at the wrong stage of growth). On the other hand, glyphosate has no selectivity and will kill all foliage that it touches.

Some Important Herbicide Terminology

Contact herbicides kill only those plant parts the spray actually touches. There is little, if any, translocation (movement) to other parts of the plant. Contact herbicides can be either selective or non-selective.

Glyphosate is a non-selective contact product that kills the green topgrowth of all weeds and crops. Propanil is a selective contact herbicide that controls many grassy and broadleaf weeds in rice without injury to the crop (it can be freely sprayed on the rice plants).

Systemic herbicides are absorbed through the leaves (less so through the roots) and then translocated throughout the plant. Systematics are especially useful for killing perennial weeds, although several applications may be needed. Many other herbicides like atrazine have a partial systemic action.

Timing and Method of Herbicide Applications

The herbicide label will state that the particular product can be applied in one or more of three ways:

- Pre-plant: Before the crop is planted. Most pre-plant herbicides require incorporation into the top 2.5-10 cm of soil with a disk harrow or rototiller.
- Pre-emergence: After the crop is planted, but before it or the weeds have emerged.
- Post-emergence: After the crop and the weeds have emerged, usually before the weeds are 2.5-5.0 cm tall.

Broadcast applications are applied over the entire field. Band applications are applied in a narrow strip (about 30-40 cm wide) centered over the crop row. These save the farmer money since less herbicide is used, but he or she will still have to cultivate the untreated inter-row area.

How Herbicide Dosages are Given

Herbicide recommendations are usually given in terms of lbs./acre or kg/ha of active ingredient* which refers to pure 100 percent chemical. However, each herbicide is usually available in several different formulations (i.e. wettable powders, liquids, granules) that vary in strength. It is up to the farmer or extension agent to figure out how much of a particular product is needed to satisfy the recommendation. This is much the same as figuring fertilizer requirements. For example 3.75 kg/ha of Gesaprim 80 percent wettable powder would be needed to supply 3 kg of active ingredient per hectare (80 percent x=3 kg; x=3.75 kg).

* For some herbicides the percentage of active ingredient may be referred to as the "acid equivalent".

Herbicide Safety

Fortunately, most herbicides are relatively safe, but there are a few exceptions:

- Paraquat has an unusually high oral toxicity and even a small amount of diluted mixture can be fatal. Paraquat is inactivated by clay or activated charcoal which should be administered orally (mixed with water) if oral ingestion occurs.
- Dinitrophenols (DNBP, Dinoseb, Basanite) have high oral toxicity and can also be absorbed dermally (through the skin) .

- Suspected birth defects caused by 2, 4-D type herbicides have been linked with faulty manufacture which produces dioxins (rarely present under current production methods).

For these reasons, it is not recommended that these herbicides be used without first receiving instructions in handling from a knowledgeable professional.

The same general safety guidelines in section B. On insecticides apply to herbicides. Except for those mentioned above, nearly all herbicides are Class 4 in their relative toxicity (least dangerous).

Factors Affecting Herbicide Performance

- Choice of product: The product must be suited to the crop and the weed species present.
- Soil organic matter and clay content: The rates of most soil-applied herbicides are very dependent on soil clay and especially organic matter content. The higher these levels, the higher the rate of herbicide needed. Some soil-applied herbicides may cause crop damage on sandy soils.
- Rainfall: Most pre-emergence herbicides require moderate rainfall within a few days following application in order to move the chemical into the weed seed germination zone. Otherwise, a very shallow cultivation may be needed to work the chemical into the soil.
- Weed size: Post-emergence applications of many herbicides will not kill weeds much taller than 2.5 cm while others will effectively control larger weeds.
- Accuracy of application: Most herbicides need to be applied at fairly precise dosages. This requires calibrating the sprayer in order to determine how much water it will take to cover the field and how much herbicide should be added to each tankful. When spot spraying, the farmer can get by using a tablespoon per gallon or cc per liter dosage, but this is the exception. Application also needs to be uniform to avoid crop injury or patches of surviving weeds.

General Guidelines For Applying Herbicides

- READ AND UNDERSTAND THE LABEL!
- Do not spray on windy days. Spray drift or vapors may damage nearby susceptible crops.
- Avoid spraying when the temperature is above 32 High temperatures increase volatility (vaporization) and may also reduce herbicide effectiveness.
- When using wettable powder formulations, be sure to agitate the sprayer tank to keep the powder in suspension during application.
- Never use a herbicide on a crop for which it is not recommended.
- Do not burn herbicide containers. Fumes may be released which can injure susceptible crops.

Herbicide Carryover

Some herbicides take a long time to break down in the soil and may injure succeeding crops. It is likely that residues may cause problems with those crops for which the product is not recommended. Fortunately, residues are less of a problem in the tropics where higher temperatures favor a more rapid breakdown of the chemicals.

Atrazine takes two to eight months for its residues to disappear, and most broadleaf crops may be injured if planted within this period. Simazine, diuron, and diphenamid may take even longer. Most others take a few weeks to a couple of months. The label should show carryover information.

Applying Herbicides with Backpack (Knapsack) Sprayers

A few herbicides do not require much dosage accuracy and can be easily applied with backpack sprayers. However, most herbicides require a level of precision, which is difficult to achieve with these sprayers unless extra care is taken.

In order to avoid applying too much herbicide, which wastes money and might injure the crop, or too little, which might make the spraying ineffective, the sprayer should be calibrated (see Appendix K).

Once the sprayer has been calibrated, the farmer must maintain the same constant spraying pressure and walking speed that was used in the calibration process.

Nozzle selection is important. Fan nozzles should be used to make pre-emergence and post-emergence applications over the soil and small weeds. Cone nozzles are best for spraying herbicides on larger weeds, since they provide more complete coverage than fan nozzles when used on foliage. They should not be used for broadcast applications of herbicides over the soil and small weeds since the circular spray patterns will not overlap properly. If two or more cone nozzles are mounted on a spray boom, overlapping spray patterns will distort each other. As for water volume, 250-300 l/ha is adequate as long as weeds are small or only the soil surface is being sprayed. Larger weeds require up to 500-600 l/ha when uniform coverage is needed. The sprayer should be shaken periodically to keep wettable powder formulations in solution.

Improvements in Hand Sprayers

- Low-volume hand-held sprayers: A very effective hand-carried sprayer that runs on flashlight batteries has been developed by IITA. It is known as a controlled droplet applicator sprayer and is specifically designed for applying herbicides. Its special nozzle produces extremely fine droplets which permit adequate coverage to be achieved with only 20 liters of water per hectare. The single nozzle covers a meter-wide swath which enables a hectare to be sprayed in about eight hours at a walking speed of 0.5 meters/ second. This is a big improvement over backpack sprayers in terms of water volume and time requirements. The controlled droplet applicator sprayer is very light and holds just 2.5 liters of spray solution. Calibration is also simplified, because the sprayer's output is constant and only walking speed need be considered. The sprayer is currently being manufactured by two companies:

- The "HERBIE" by Micron Sprayers Ltd., Bromyard, Herefordshire, ENGLAND HR7 4HU. This model uses eight flashlight batteries (good for up to five hectares of spraying).
- The "HANDY" by Ciba-Geigy AG, CH 4000, Basle 7, SWITZERLAND. Uses five flashlight batteries.

The price of the controlled droplet applicator is about half that of a backpack sprayer. However, it is not suitable for applying most insecticides and fungicides.

A spray boom for backpack sprayers: To reduce labor requirements for backpack spraying, a simple but effective spray boom can be constructed so that two to five nozzles can be used at once. If only two nozzles are used, special "T" extensions are commercially available for many sprayer models. Larger booms can be made by arranging nozzles along a length of narrow diameter pipe and connecting them with high-pressure plastic hose. If fan nozzles with an 80° angle of spray width are used and spaced 50 cm apart on the boom, uniform ground coverage can be achieved when the boom is carried about 50 cm off the ground. (This provides three to four fingers width of overlap between adjacent spray patterns. As shown in the illustration, these large booms are too unwieldy to be carried by the sprayer operator alone.

Applying Herbicides with Tractor Boom Sprayers

Tractor boom sprayers can cover up to six to eight rows at once and have nozzles spaced every 40-50 cm. They may be used on small farms as part of a cooperative venture. Here are some guidelines:

1. Low sprayer pressures (30-40 lbs./ sq. in.) are usually recommended for herbicides. Higher pressures decrease droplet size, distort the spray pattern, and cause drift.
2. For nozzle selection follow the guidelines listed under backpack sprayers. Brass, aluminum, and plastic nozzle tips are cheapest. However, they wear much faster than tips made of harder metals when wettable powders are used.
3. If output per nozzle is too low, switch to a larger nozzle size or drive slower. Increasing pressure is a poor way of increasing spray volume. Pressure must be increased four-fold in order to double the output.
4. When broadcasting herbicides over the soil or on very small weeds, the sprayer boom height should be adjusted to give three to four fingers width of overlap between adjacent spray patterns. Fan nozzles are available with different spray width angles such as 65°, 73°, and 80°. The wider the angle, the closer to the ground the boom can operate and still achieve the necessary overlap. This is a big advantage on windy days.
5. Nozzles of different sizes or spray angles should not be used on the same boom.
6. The manufacturer's tables for output and calibration are not reliable. Nozzle output can be markedly affected by wear, and pressure gauges and tractor speedometers vary in accuracy.
7. Wettable powder formulations need constant agitation to stay in suspension. Mechanical or hydraulic jet agitation is a must for tractor sprayers.
8. The tractor must be driven at a constant speed while spraying or output will be affected. A fluctuation of only 1-2 km/hr can increase or decrease the dosage being applied by as much as one third.
9. Tractor speed should be adjusted to suit ground conditions. Excessive bouncing of the spray boom will cause uneven coverage. The tractor should not be driven faster than 8 km/hr.
10. It is important to check constantly for blocked nozzles while spraying.

Boom backpack sprayer

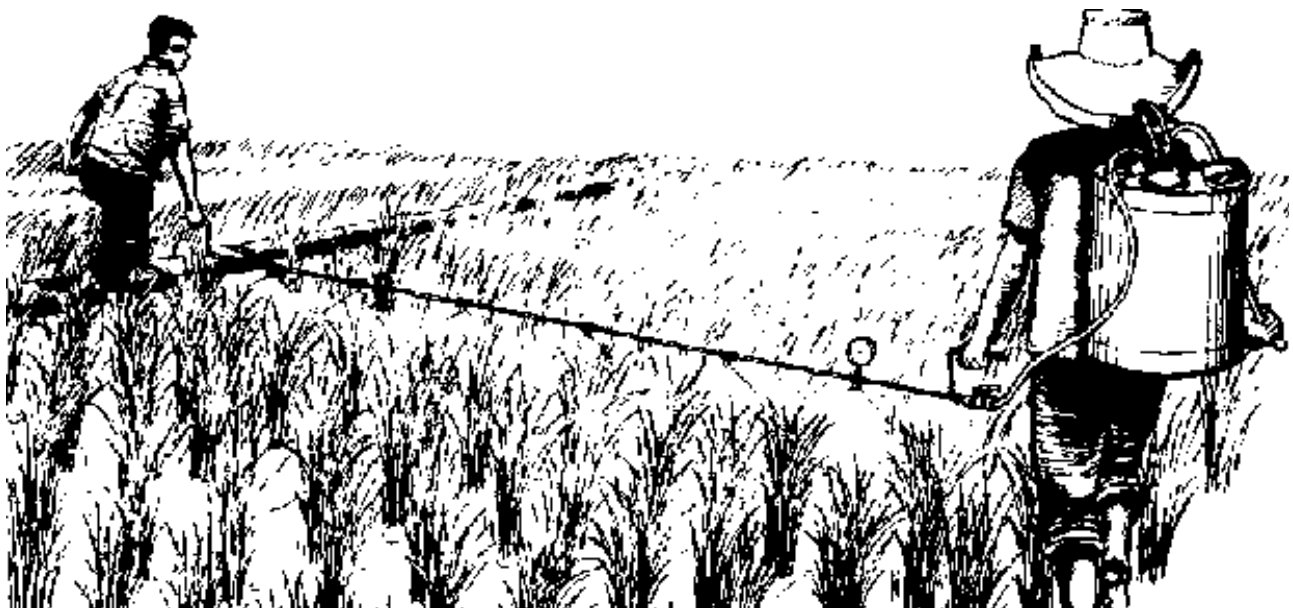

A boom arrangement for backpack sprayers (courtesy of IRR1). About 4-6 nozzles can be used when applying low water volume as with many pre- and early post-emergency herbicides.

RECOMMENDED HERBICIDES FOR THE REFERENCE CROPS

The number of herbicides available for use on the reference crops and their individual application guidelines are too numerous to be adequately covered in this manual. It is best to rely on locally-derived recommendations based on field trials if possible. Several resources are listed in the bibliography that will provide reliable general guidelines for herbicide selection and dosages.

Insect control

Some Important Facts on Insects

Insects can often be identified by the type of damage they cause:

- Chewing and Boring Insects

Caterpillars are the larvae of moths. They damage plants by feeding on leaves and making holes in them or by boring into stalks, pods, and maize ears. The cutworm caterpillar is unusual in that it lives in the soil and emerges at night to cut off plant stems near ground level.

Beetles feed on plant leaves and chew holes in them. Some beetles of the weevil family bore into pods and seeds and deposit eggs inside. Certain beetles can also transmit bacterial and viral diseases.

Beetle larvae like white grubs, wireworms, and rootworms live in the soil and damage roots and the underground portion of the stem by chewing or boring.

- Sucking Insects

Aphids, leafhoppers, stinkbugs, harlequin bugs, whiteflies, and mites have piercing and sucking mouthparts and feed on plant sap from leaves, pods, and stems. They transmit a number of plant diseases, especially viruses. Sucking insects do not make holes in the leaves, but usually cause leaf yellowing, curling or crinkling.

Insect Life Cycles

A general understanding of insect life cycles is useful in identifying insect problems in the field. Beetles and moths go through a complete metamorphosis (change in form) consisting of four stages, while aphids, leafhoppers, whiteflies and other sucking insects go through only three stages.

(Adult stage)

MOTH ∅ EGG ∅

(Does no damage.)

CATERPILLAR	∅	PUPA
(Usually feeds on leaves.)		(Dormant stage; turns into a moth.)

(Adult stage)

BEETLE ∅ EGG

(Feeds on leaves, pods)

LARVA (Grubs, wireworms, rootworms, etc. Feed on plant roots.)	∅	PUPA (Dormant stage turns into a beetle.)
-------------------------------------------------------------------	---	----------------------------------------------

(Adult stage)

APHIDS, LEAFHOPPERS, STINKBUGS, WHITE-FLIES, OTHER SUCKING INSECTS ∅

EGG ∅ NYMPH

(Looks like a miniature adult; at this stage also sucks sap.)

How to Identify Insects and Their Damage

BE OBSERVANT! Troubleshooting takes practice, and a sharp eye is essential. When walking through a field, closely examine the plants for insects or their damage symptoms. Check both sides of the leaves since many insects prefer the undersides of leaves. A magnifying glass can be very helpful.

Identifying Insect Damage: Often it is possible to identify insects by the damage they cause.

- Holes in leaves: Caused by caterpillars, beetles, crickets, snails, and slugs. (Snails and slugs are not insects but do attack plant foliage.)
- Wilting: Usually caused by soil insects like white grubs and wireworms. If root feeding or tunneling of the underground portion of the stem has been serious it could be due to stem borers. Remember that wilting can be caused by other factors, too: dry soil, very high temperatures, root rots, bacterial and fungal wilts, and nematodes.

To determine if insects are the cause of wilting, dig up the affected plants. Check the root system and underground portion of the stem for insect and disease damage, also look for soil insects. Slit the stem lengthwise with a pocket knife and check for borers or rotted tissue.

- Leaf curling, crinkling or yellowing: Caused by sucking insects, especially aphids, leafhoppers, and mites. Viruses and some nutrient deficiencies also produce these symptoms. Nematodes and poor drainage cause yellowing too.

Identifying Insects: Spend time with locally experienced extension workers in the field and have them point out the prevalent crop insect pests (and beneficial predator insects) in the work area. Seek out host country or regional insect guides such as extension bulletins. The publications listed in the bibliography are also very useful.

Major pests of the reference crops

This list is not complete but deals with the more prevalent reference crop pests. Full or partial (genus only) scientific names are given in parentheses. More specific control measures will be given at the end of the insect section. Stored grain pests, some of which attack the crops before harvest, will be covered in Chapter 7.

Major Pests Of Maize

Soil Insects

White grubs (Phyllophaga, others): Brown headed, plump, six-legged, white larvae up to 25 mm long. Many are larvae of May (June) beetles and attack roots of maize and other grass family crops, sometimes causing serious damage. Especially common where maize is planted on recently cleared pasture land. Occasionally attacks legumes. Larval stage lasts one to three years.

Rootworms (Diabrotica, others): Small, slender, whitish larvae with brown heads, measuring up to almost 20 mm. They attack the roots and sometimes bore into the underground portion of the stalk while adult beetles feed on the silks and attack other crops. They are most prevalent in Latin America. Affected plants often become "goosenecked" because of lodging caused by root damage. Ten or more larvae per plant or a brown discoloration of 50 percent of the root system indicates serious damage.

Wireworms (Elateridae): Shiny, brown, hard larvae up to 1.5 - 3.5 mm long with six legs. The larval stage of click beetles attack germination seeds and below ground plant parts. Larval stage lasts two to six years.

Wireworm Larva (top) and Adult (bottom)



Cutworms (Agrotis, Feltia, Spodoptera): These are caterpillars ranging from bright green to black. Most are rather plump and curl up when disturbed. They attack young plants and cut off stems at or slightly above the soil surface, but some will feed on the leaves. Most remain below ground during the day and emerge at night to feed.

Lesser cornstalk borer (Elasmopalpus): Caterpillars, usually light green with faint stripes and distinct vertical bands of brown. They are most common in Latin America. Young larvae feed first on the leaves and then bore into the stalk about 2-5cm above ground. Each builds a tunnel made of soil particles and silk that runs from the soil to the stalk hole. May also attack the root system. Larval stage lasts about three weeks and pupation takes place in the soil in a silken cocoon.

Seed corn maggots (Hylemya): Yellowish gray fly larvae up to 6-7 mm long with a blunt rear end and a sharply-pointed head. They attack germinating seeds, sometimes eating out the entire kernel.

Maize Foliage Insects and Borers

Fall armyworm (Spodoptera frugiperda): Larvae have a green and brown coloring with a prominent, white, inverted "Y" mark on the head and grow to about 40 mm. One of the most serious and prevalent maize insects in the lowland tropics. The caterpillars are larvae of night-flying moths that lay eggs in clusters of 100 or more on the leaves. Eggs are covered by a coating of body hairs and scales and hatch in two to six days in warm weather. The larvae are cannibalistic and attack each other until only a few are left. They then move to the leaf whorl and feed on the unfolding leaves, but may also damage the growing point in older plants. Larva will sometimes tunnel into older plants. The larval stage lasts about three to four weeks and the pupal stage only 10 days, so maize can be attacked by several generations. Damage is easy to spot by the ragged appearance of the leaves and the large amount of sawdust-like excrement found around the leaf whorl. Diseases and predators may greatly reduce their numbers. Liquid or granular insecticides applied to the leaf whorl are effective and should be applied before the larvae have reached 16-18 mm.

Seedcorn Maggot. A— Mature larva; B—Adult; C—Injured germinating seed.



Corn earworm (*Heliothis zea*): A striped yellow, brown or green caterpillar. The moth deposits her eggs individually on the maize silks. Eggs are white, round, and smaller than the period at the end of this sentence, but can be easily seen with a low power magnifying glass. They hatch in three to seven days, and the larvae feed on the young silks and kernels near the ear tip. Earworms seldom interfere with pollination, since most silks become pollinated the first day they emerge from the ear. Eggs are sometimes laid on the leaves of younger plants, followed by leaf feeding in the whorl as with the armyworm. Ear damage is rarely serious enough to justify using insecticides, which would have to be applied to the silks—a time-consuming process. Varieties with long, tight husks have good resistance.

Leafhopper Adult



Corn Earworm A - Egg; B - Mature larva; and C - Adult.

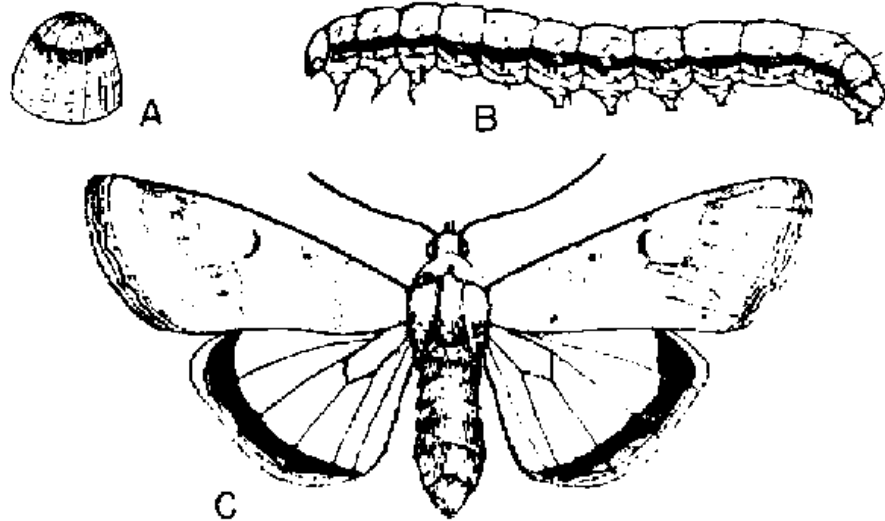

Miscellaneous leaf-feeding caterpillars (yellow striped armyworm, true armyworm, measuring worm, etc.): These may occasionally require foliar insecticide sprays.

Southern cornstalk borer (Diatraea), Southwestern corn borer (Zea diatraea): Prevalent in lowland areas of Latin America. Moth larvae are about 25-mm when fully grown and are white with dark spots. Eggs are laid in overlapping rows of 10-12 on the leaves near the central veins. Eggs hatch in three to six days, and young larvae spend two to three days feeding on the leaves, making circular holes, before they bore into the stalk. Larval stage lasts several weeks, and pupation takes place inside the stalk. Control is only partly successful and requires spraying the plants during the short period before the larvae bore into the stalks or the use of systemic insecticides, some of which are very toxic.

Stalk borers (Busseola, Sesamia, Eldana, Chilo): Very common in Africa and parts of Asia and can cause serious losses. Busseola and Sesamia prefer young plants and can kill them by damaging the growing point. All four types may attack the ears on older plants in addition to the stalks. Busseola moths mate soon after emergence from the pupal stage and deposit their eggs in groups of 30-100 on the inner leaf sheath near the whorl. The larvae feed on the whorl and then tunnel into the young plant. Systemic insecticides applied to the soil or to the leaf whorl give fair to good control. Eradication of wild grasses that serve as borer hosts helps reduce numbers.

Leafhoppers (Cicadulina Dalbulus): Small, light-green, wedge-shaped insects with piercing-sucking mouthparts. Cicadulina transmits maize streak virus in Africa, and Dalbulus spreads corn stunt virus ("achaparramiento") in Latin America. Both diseases can cause serious losses. Insecticides are effective.

Grasshoppers: Cause serious losses in parts of Africa. Foliar sprays and baits are effective unless the infestation is severe.

Aphids—Wingless and Winged (USDA)

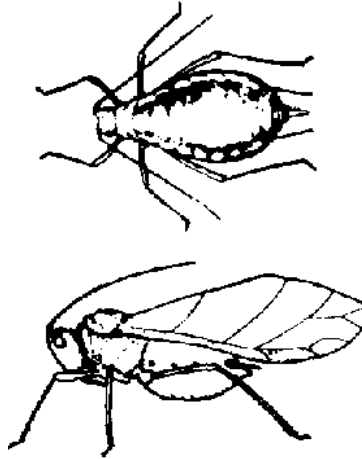

Maize aphids (Rhopalosiphum): Small, soft-bodied, green or blue, green insects that suck sap from plants and secrete a sweet substance (honeydew) on which a black mold grows. They can stunt and deform the tassels, causing poor pollination. Treatment should be considered if 50 percent of the plants have some aphids and 10-15 percent are heavily infested. Systemic insecticides give long-term control.

Common Storage Insects of Cereal Grains

Maize weevil (Sitophilus zeamais), rice weevil (S. oryzae), and granary weevil (S. granarius): All have long snouts and are about 8.3mm long. Only the maize and rice weevils can fly and infest crops in the field. Females live several months and lay 200-400 eggs by boring holes in the kernels and depositing the eggs inside. The white, legless larvae feed on the inside of the kernels, then pupate, and finally emerge as weevils. All three species are more common in humid than dry regions.

Angoumis grain moth (Sitotroga cerealella): A small cream- or tan-colored moth with a wingspan of about 12.7 mm that is often the major stored grain pest in drier regions. Adult moths have a black fringe on the tip of each forewing. They can infest grain both in the field and during storage, but can penetrate only about the top 4-inch layer in stored, threshed grain. Maize stored as ears can be completely infested, however. Each female lays about 40-400 eggs on the outside of the kernels, and the tiny larvae burrow inside to feed. Pupation takes place inside the kernel, and the young moths emerge to begin a new cycle. The moths themselves do no feeding. Unlike most other storage insects, the angoumis grain moth can be controlled by spraying or dusting only the surface layer of stored, threshed grain with an approved insecticide like Malathion or pyrethrin.

Major Sorghum Pests

Sorghum is attacked by many of the same insects that attack maize, but two other insects can also cause serious damage.

Sorghum midge (Contarinia sorghicola): A small orange fly about 2 mm. This is the most important sorghum pest worldwide. The adult lives only about a day and lays eggs on sorghum grain heads during flowering. Larvae hatch in two to four days and spend 9-11 days feeding on the juices of the developing seeds, preventing them from developing. The pupal stage lasts two to six days for a total life cycle of just 15-20 days.

Some local varieties show fair resistance to this pest. Sorghum heads can be sprayed with an insecticide three to five days after they emerge from the boot. Sorghum should not be planted near young sorghum or Johnsongrass, and out of season sorghum heads should be removed from fields. In cooler areas, the larvae pupate in a silken cocoon, but may also do this in very hot, dry weather. Plowing under residues may help control the pest in these cases.

The sorghum midge, *Contarinia sorghicola* (Coq.). Adult female and larva in its cocoon.

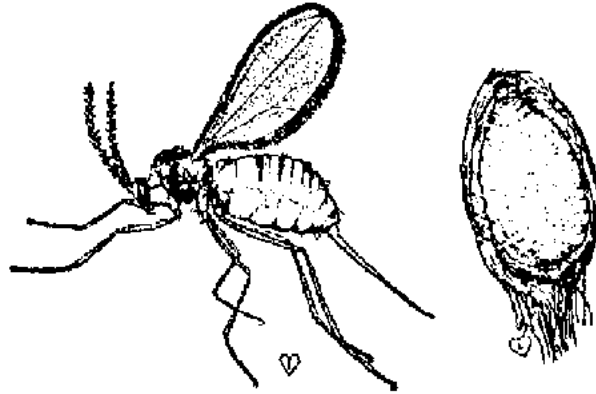

Sorghum shoot fly (*Atherigona soccata*): A major pest in Africa and Asia. Adults look like small houseflies and lay eggs on the leaves of young plants. Larvae move down into the leaf whorl and then bore into the young stem, often killing the growing point. The youngest leaf then turns brown and withers-this condition is called "deadheart". Some sorghum varieties show shoot fly resistance. Insecticides applied to the whorl are not as effective as pre-plant applications of systemic insecticides to the soil.

Maize Weevil (*Sitophilus zeamais*). The rice weevil (*S. oryzae*) looks identical.

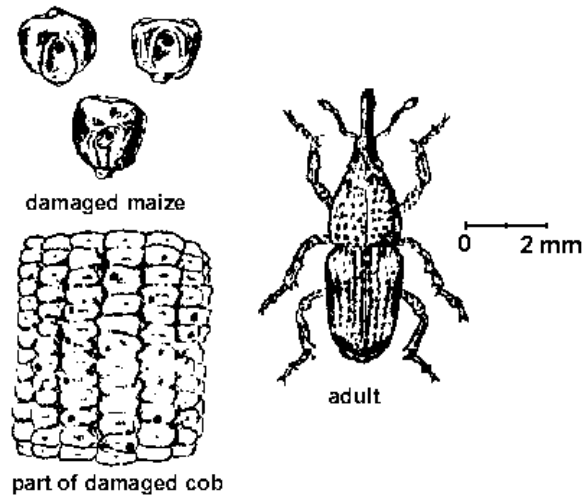

Millet Pests

Millet is attacked by many of the same insects as sorghum, including the shoot fly, midge, and stem borer, but damage is usually less serious. The millet grain midge (*Geromyia pennisetti*) is common in the savanna region of Africa. A caterpillar (*Masalia spp.*) has increased in numbers in the northern savanna and Sahel during the 1970's and can cause serious head damage.

Sorghum Shoot Fly

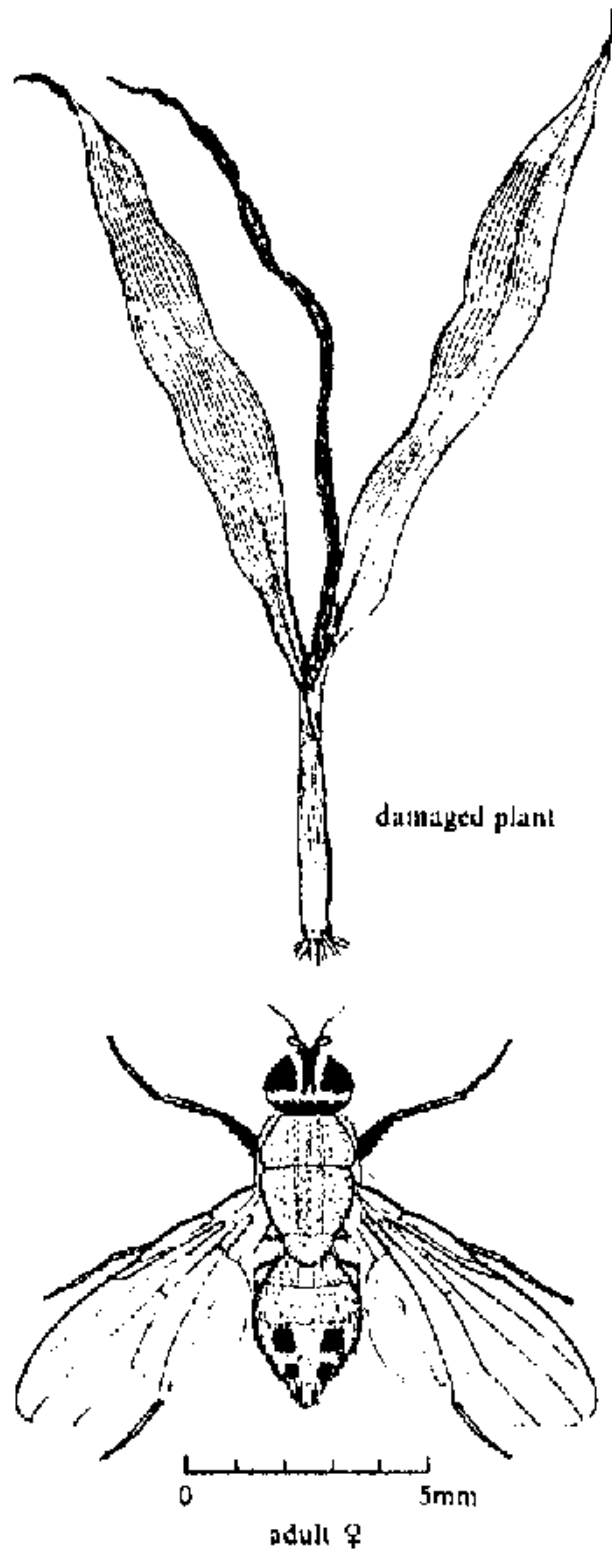

Peanut Pests

The flower thrips, *Frankliniella tritici*

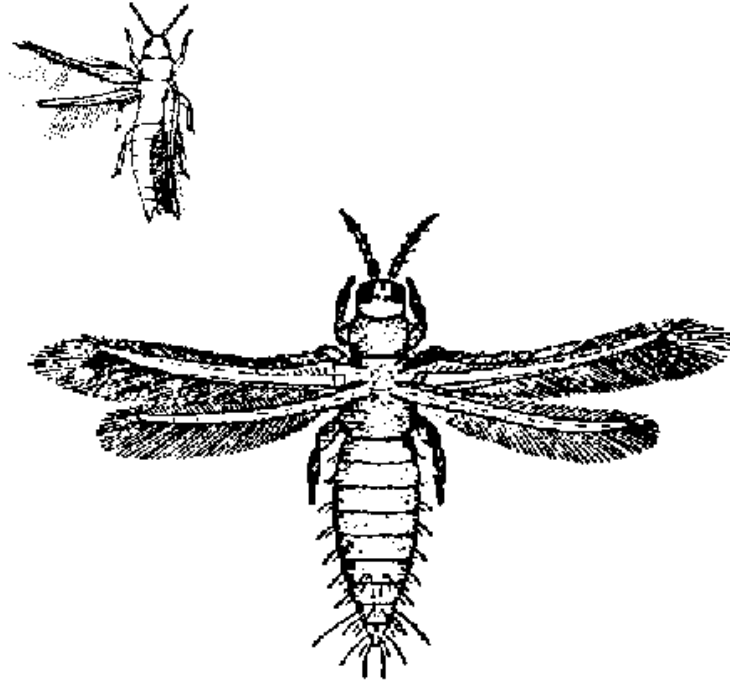

White grubs, wireworms and rootworms attack peanut roots, and the latter two also attack the pods.

Termites can severely attack the pods, but damage is usually patchy. Treating planting seed with an insecticide, destroying the nests with Chlordane or other insecticides, or applying insecticides broadcast or banded along the crop row are effective on termites.

The lesser cornstalk borer may bore into stems and pods. In Senegal, about a dozen types of millipedes damage pods. Any pod damage increases the likelihood of aflatoxin (a harmful toxin and carcinogen produced by Aspergillus fungus; see section on diseases).

Thrips: These tiny(1 mm) yellow to black insects have two sets of fragile wings which are fringed with hairs along the rear edge. Immature thrips (nymphs) are light yellow to orange and smaller than the adults. If disturbed, thrips will jump or hop. They can cause serious damage by feeding in the buds or folded leaflets. They have rasping-sucking mouthparts which cause the leaves to be scarred and distorted as they unfold. Thrips can also spread spotted wilt virus.

Leafhoppers: Can be another major pest. Adults are around 3 mm long, pale green, and wedge-shaped. Immature leafhoppers (nymphs) are similar in appearance to adults, but smaller and without wings. Both stages have piercing-sucking mouthparts. The first signs of leafhopper damage are yellow "V" formations at the leaf tips, and severe cases can cause stunting and leaf drop.

Spider mites (Tetranychus and other species: Common in hot, dry conditions. They are sucking insects, and feeding damage may appear as translucent dots on the leaves. Some insecticides will not control mites, while Kelthane is effective only against mites.

Corn earworms (Heliothis spp.), armyworms (Spodoptera, Pseudaetia), and other caterpillars feed on the leaves. Blister beetles (Epicauta spp.) are brightly colored with alternate bands of black and red or yellow-they feed on the flowers. Aphids occasionally attack peanuts. One species (Aphis croccivora) spreads rosette virus, a serious problem in Africa.

Peanuts are very susceptible to attack by storage insects. The groundnut bruchid (Caryedon spp.) is a serious pest in West Africa. This weevil lays eggs on the pods after the crop has been lifted from the ground, and the larvae tunnel into the pods and kernels.

A Spider Mite (Univ. of Arizona)

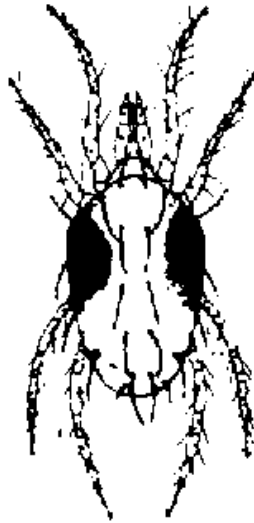

Bean Pests

The following information is based on The International Center for Tropical Agriculture (CIAT) studies on the mayor insect pests of common beans (Phaseolus vulgaris) in Latin America.

Seedling Stage Insects

Cutworms and white grubs may cut off the stems of young seedlings. White grubs are usually only serious when beans are planted following pasture. The lesser cornstalk borer may bore into the stem just below the soil surface and move upwards and kill the plant. Clean fallowing for long periods or heavy flooding will control these borers as will granular insecticides applied near the seed row at planting.

Leaf Feeding Insects

Many species of beetles, such as the banded cucumber beetle (Diabrotica balteata), bean leaf beetle (Cerotoma), flea beetle (Epitrix), and Mexican bean beetle (Epilachna), attack bean leaves. The most serious damage is caused during seedling stage when the insects can defoliate the plant more readily, or during flowering. Both larvae and adults of the Mexican bean beetle feed on the leaves. The larvae of the other beetles feed mainly on the roots of beans, maize, and certain weeds.

Caterpillars usually do not cause economic damage on bean leaves. The bean leafroller (Urbanus or Eudamus), saltmarsh or wooly bear caterpillar (Estigmene), and Hedylepta caterpillar are the most common.

Sucking Insects

The leafhopper species Empoasca Kraemeri is the most serious insect pest of beans in Latin America and is also found in other regions. It does not transmit virus (some other leafhoppers do) but causes severe stunting, yellowing, and leaf curling. Work done by CIAT has shown that yields are reduced about six percent for each leafhopper present per leaf. Eggs hatch in eight to nine days and the nymphs feed on the plants for eight to eleven days before becoming adults. The adult stage lasts about 60 days and is more damaging. Beans grown with maize are less affected than pure stands. Mulching reduces leafhopper populations. Leafhopper problems are generally more severe in hot, dry weather.

Several species of aphids attack beans, although their feeding causes little direct damage, they can transmit bean common mosaic virus.

Mexican Bean Beetle - Adult and Larva

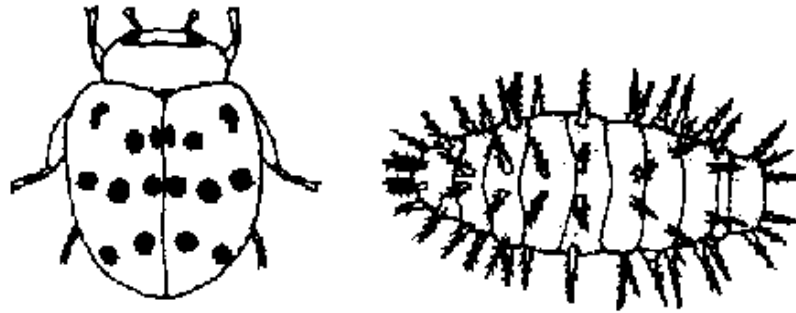

Several species of mites attack beans. The red spider mite is found on the lower leaf surface, and heavy infestations turn the leaves brown. The tarsonemid mite is too tiny to be seen without a magnifying glass, but causes young leaves to curl up-ward. Mites are seldom serious except during the dry season.

Whiteflies (Bemisia spp.) do not usually cause direct damage but can transmit bean golden mosaic virus and bean chlorotic mottle virus. They are often controlled by natural predators, and most insecticides are effective.

Pod Borers

The bean pod weevil (Apion godmani) is a serious problem in Central America. Adults are black and about 3 mm long and they feed on flowers and pods without causing much damage. However, the female chews a small hole in young pods and deposits an egg. The larva feeds on the inner pod and the developing seeds. Pupation takes place in the pods, and the adults emerge near harvest time. Bean types vary in their resistance. A number of insecticides give good control if applied once at a week past flower initiation and again a week later. Carbofuran applied at planting gives excellent control.

Bean bruchids (Acanthoscelides obtectus and Zabrotes subfasciatus) are snout less weevils about 2.5mm long and are the major storage pests of beans. A. obtectus predominates in cooler areas, while Z. subfasciatus prefers warmer regions. Life cycles for both are very similar with eggs being laid on stored beans or in cracks of growing pods in the field. The larvae tunnel into the seeds to feed.

Adult weevils are short-lived and do little feeding. Both types of weevils may be present initially, but A. obtectus is a better competitor at lower temperatures and will eventually predominate under these conditions. These bruchid weevils are estimated to cause storage losses of up to 35 percent in Mexico and Central America.

Slugs occasionally cause serious leaf damage and are mainly active at night or on wet, cloudy days. Damage is most likely along field borders but may move inward. Cleaning the field of weeds and plant debris helps control them, but baits are the most effective means of control. Slime trails on the leaves indicate the presence of slugs.

Cowpea Pests

The caterpillar Maruca testulalis is the major cowpea pest in the Savanna region of Africa. It attacks flowers, pods, and leaves, causing yield losses up to 70-80 percent.

Coreid bugs (plant bugs) are larger sucking insects that feed on green pods and cause them to shrivel and dry prematurely.

The leaf feeding beetle Ootheca mutabilis can cause yield reductions when young plants are heavily attacked. It also carries yellow mosaic virus.

The flower thrip (*Megalurothrips sjostedti*) is a major cowpea pest in tropical Africa. Thrips have sucking-rasping mouthparts and are very small (about 1 mm or less).

The snoutless bruchid weevils (*Callosobruchus spp*) infest cowpeas both in the field and in storage. The adults can fly up to a kilometer and are most likely to infest crops downwind from storage facilities. The 2.5 mm adults lay eggs on the pods or seeds, and the larvae bore into the grain.

IITA, in Nigeria, estimates that one-third of the cowpea crop in Africa is destroyed by bruchids.

Cowpea bruchids (*Callosobruchus spp.*)

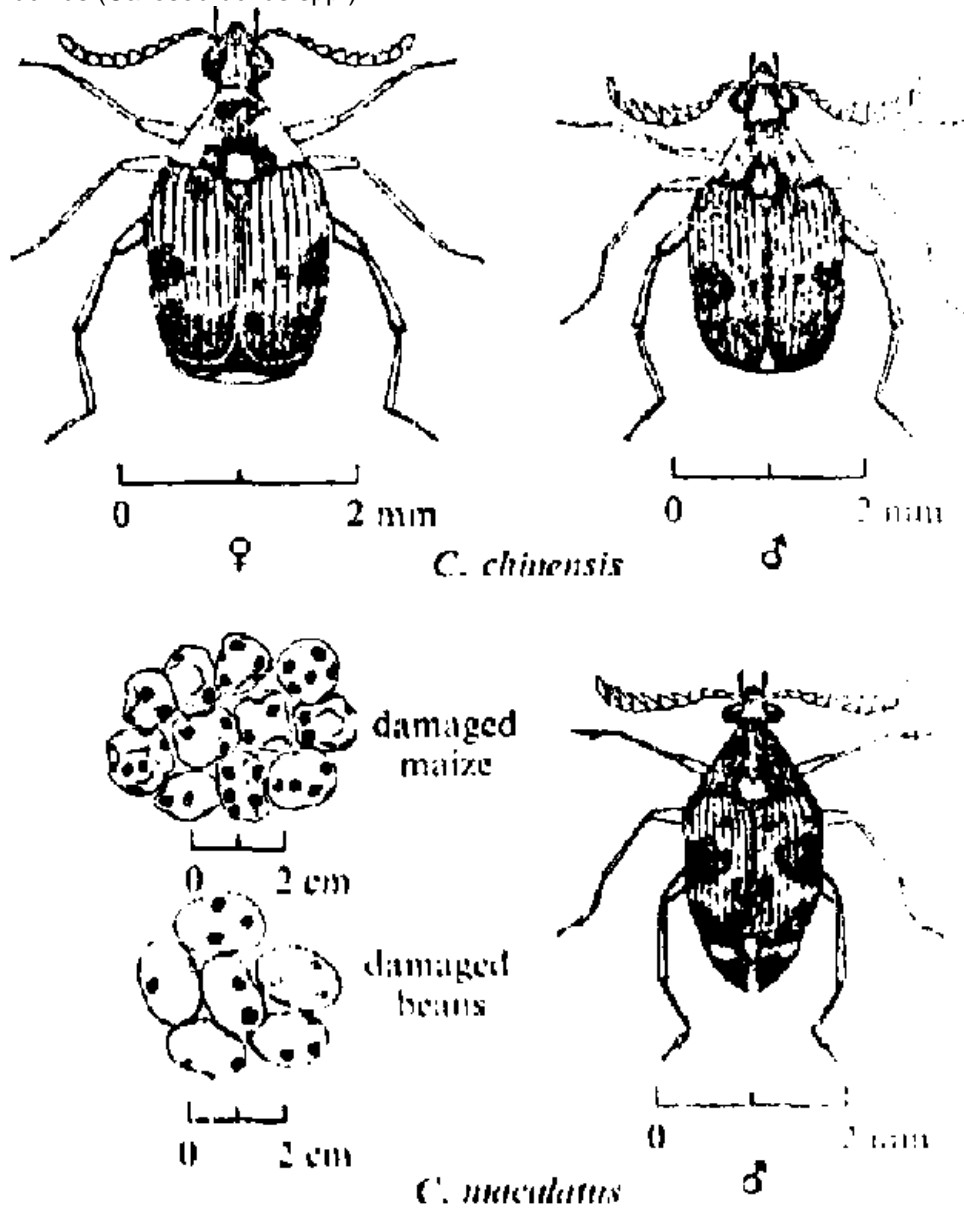

Methods of insect control

Non-Chemical Methods

Many natural controls act to keep insects in balance:

- Weather factors like temperature and rainfall can restrict the distribution of an insect species. For example, mites and leafhoppers are usually more prevalent under dry conditions.
- Geographic barriers like large bodies of water, mountains, and deserts can also limit insect distribution.
- Frogs, toads, lizards, moles, and birds are some of the many animals that feed largely on insects.
- Beneficial predator insects like ladybugs feed on aphids, while others like the braconid wasp and tachnid fly lay eggs on or in certain pests which are killed by the developing larvae. Some predator insects like the praying mantis eat beneficial insects as well, however. Insects are also attacked by viruses, fungi, and bacteria which help keep populations down.

As agricultural activities have increased, many of these natural balances have been upset and can no longer be relied upon to keep harmful insects under control. Monoculture and the existence of vast areas under cropping have led to marked increases in a number of insect pests. Indiscriminate use of pesticides has actually resulted in buildup of harmful insects in some cases. Many of the traditional crop varieties, despite their lower productivity, have better insect resistance than some of the improved varieties.

Biological Control

Biological control is the purposeful introduction of predators, parasites or diseases to combat a harmful insect species. About 120 different insects have been partially or completely controlled by this method in various parts of the world. Microbial insecticides such as Bacillus thuringiensis (effective against a few types of caterpillars) are now commonly used by farmers and gardeners in many areas. Unfortunately, biological control measures are presently effective against a very small portion of harmful insect species.

Cultural controls

Cultural controls such as crop rotation, intercropping, burying crop residues, timing the crop calendar to avoid certain insects, and controlling weeds and natural vegetation that harbor insects are all effective control methods for some insects. In most cases, however, cultural controls need to be supplemented by other methods.

Varietal Resistance

Crop varieties differ considerably in their resistance to certain insects. For example, maize varieties with long, tight husks show good resistance to earworms and weevils. Researchers at CIAT have found that some bean varieties are relatively unaffected by leafhopper damage during the wet season, while others suffer yield losses of up to 40 percent. Screening for insect resistance is an important part of crop breeding programs.

"Organic" Controls

"Organic" control refers to non-chemical methods in general. These include the application of homemade "natural" sprays made from garlic, pepper, onions, soap, salt, etc., and the use of materials like beer to kill slugs and wood ashes to deter cutworms and other insects. Some of these "alternative" insecticides are slightly to fairly effective on small areas like home gardens and where insect populations are relatively low. They are seldom feasible or effective on larger plots, especially under tropical conditions that favor insect buildup.

Chemical Control

Chemical control refers to the use of commercial insecticides in the form of sprays, dusts, granules, baits, fumigants, and seed treatments. While some of these insecticides like rotenone and pyrethrin, are naturally derived, most are synthetic organic compounds that have been developed through research.

Advantages of Insecticides:

- They act rapidly.
- They are the only practical means of control once an insect population reaches the economic threshold of damage on a commercial-size plot.
- They are available with a wide range of properties, species effectiveness, and application methods.
- They are relatively inexpensive, and their proper usage can often return \$4.00 5.00 for every \$1.00 spent.

Disadvantages of Insecticides:

- Insect resistance to pesticides: This is a growing problem. By 1961, 60-70 species had developed resistance to certain products, and the number had increased to around 200 by the mid-1970's.
- Outbreaks of secondary pests: Few insecticides kill all types of insects, and some actually promote the increase of certain pests. For example, continual use of Sevin (carbaryl) in the same field may increase problems with some types of aphids which it does not control well.
- Damage to non-target species: These include beneficial predators such as bees and wildlife.
- Residue hazards: Some chlorinated hydrocarbon compounds like DDT, Aldrin, Endrin, Dieldrin, and Heptachlor are highly persistent in the environment and may accumulate in the fatty tissues of wildlife, lives, and humans. Many other insecticides are broken down into harmless compounds fairly rapidly.
- Immediate toxicity: Some insecticides are extremely toxic in small amounts to humans and animals. Again, it is important to realize that insecticides vary greatly in their toxicity.

Current Status of Insecticide Use in the Reference Crops

At the present time and for the immediate future, insecticide usage will often be an essential part of any package of improved practices for the reference crops. For this reason, all extension workers must learn the basic principles of safe and effective insecticide application. Some extension workers may be personally opposed to the use of these chemicals, but it is a fact that farmers throughout the developing world are using them, often in an unsafe and indiscriminate manner due to the lack of proper instruction. Most developing countries have few, if any, pesticide regulations or restrictions on environmentally harmful products like Aldrin or highly toxic ones like Parathion. By instructing farmers in safety precautions and in the appropriate choice and use of insecticides, the incidence of human poisoning and possible environmental damage can be greatly reduced.

Integrated Pest Control

The disadvantages of total reliance on insecticides have given rise to integrated pest control or pest management which involves the judicious use of these chemicals based on the following guidelines and principles:

- The development and use of cultural and other nonchemical control methods to avoid or reduce insect problems.

- Determining crop tolerance to pest damage based on the principle that complete freedom from pests is seldom necessary for high yields. Nearly all plants can tolerate a surprising amount of leaf loss before yields are seriously affected.
- The appropriate timing and frequency of treatments to replace routine, preventative spraying. Treatments are not initiated before the particular insect has reached the economic damage threshold, which will vary considerably with the species. Insect scouting-looking for related kinds and number of insects and their density and population counts-is an essential part of this system.

The advent of integrated pest control dates back to the early 1970's, and most of the efforts have been directed at cotton where insecticides frequently account for up to 80 percent of total production costs. Some remarkable successes have been achieved with other crops as well. For the reference crops, integrated pest control is still in the very early stage, especially in developing countries.

USING INSECTICIDES SAFELY

Insecticide safety guidelines, toxicity data, and first aid measures are covered in Appendix J, which should be referred to before working with insecticides.

Some important facts on insecticides

Pesticide Terminology

Pesticide: A general term referring to chemicals that control crop insects, mites, weeds, diseases, nematodes and rats.

Miticide (acaricide): A pesticide that kills mites. Mites are related to spiders and not all insecticides will kill them. Some pesticides like Kelthane control only mites, while others like Diazinon and Malathion kill mites and other insects.

Nemade: A pesticide that kills nematodes. A few insecticides like carbofuran and Mocap will also control nematodes, but most will not. Some nemades like Nemagon control only nematodes, while others like VAPAM, Basamid, and methyl bromide are general soil sterilants that kill insects, weeds, fungus, and bacteria as well.

Systemic vs. Non-Systemic Insecticides

Nearly all modern insecticides are contact poisons that kill insects by being absorbed through their bodies. Contact poisons act as stomach poisons if eaten by insects. Most insecticides are non-systemic and are not absorbed into the plant. Systemic insecticides are absorbed into the plant sap, and most are translocated through-out the plant. Most systemic insecticides like Metasystox, Dimethoate (Rogor, Perfection), and Lannate are sprayed on plant foliage. Others like carbofuran, Thimet, and Dis-yston, are applied to the soil in a band along the crop row, where they are absorbed by the plant roots and then translocated to the stems and leaves. Some of these soil-applied systemics will also control certain soil insects.

There are several considerations in choosing between a systemic and non-systemic insecticide:

- Systemic insecticides are especially effective against sucking insects like aphids, leafhoppers, stinkbugs, and thrips since these feed on the plant sap. However, many non-systemic contact insecticides will also control sucking insects adequately.
- Most systemics are less effective against caterpillars and beetles, but may give good control of some stem borers.

- Foliar-applied systemics may remain in the plant for up to three weeks. Soil-applied systemics may provide control for up to six weeks. However, this also means that they must not be applied close enough to harvest time to cause residue problems.
- Most systemics will not harm beneficial insects.
- Foliar-applied systemics are not broken down by sunlight or washed off the leaves by rainfall as with non-systemics.
- Since they are translocated, systemics do not require uniform spray coverage when they are applied to the leaves. New growth occurring after application is also protected.
- Some systemics like Thimet, Di-syston, and Systox are highly toxic both orally and dermally. However, the same is also true with some non-systemics like Parathion and Endrin. (See Appendix J.)

Types of Pesticide Formulations

Most insecticides are available in several types of formulations:

- WETTABLE POWDERS SOLUBLE POWDERS: These range in strength from 25-95 percent active ingredient and are meant to be diluted with water and applied with a sprayer. For example, Sevin 50 W is a wettable powder containing 50 percent pure carbaryl by weight. Once mixed with water, wettable powders require periodic agitation (shaking or stirring to keep them from settling to the bottom. Soluble ' powders ("SP") are completely soluble and do not require agitation.
- EMULSIFIABLE CONCENTRATES ("EC" or "E"): these are high strength liquid formulations. Like wettable powders, EC's are meant to be diluted with water and applied with a sprayer. They contain 20-75 percent active ingredient. In countries using pounds and gallons, a label that reads "Malathion 5 E" would refer to a liquid formulation of malathion that contains 5 lbs. active ingredient per gallon. Where liters and grams are used, EC's are often labeled in terms of grams of active ingredient per liter. For example, Tamaron 600 is a liquid formulation of Tamaron containing 600 grams of active ingredient per liter.
- DUSTS ("D"): Unlike WP's and EC's, dusts are low strength formulations (1-5 percent active ingredient) and are meant to be applied without dilution by a duster. Dusts are usually more expensive than WP's or EC's due to higher transport costs per unit of active ingredient. However, if dusts are blended within the country, they may be competitive cost-wise and are especially suited to situations where a farmer has difficulty transporting water to his field. They do not stick to the leaves as well as sprays and are more easily washed off by rainfall. Retention is improved if they are applied while the leaves have dew on them. Dusts pose more of an inhalation hazard than sprays. They should never be mixed with water.
- GRANULES "(G)": Like dusts, granules are low-strength formulations meant to be applied without dilution. They are especially well suited for soil applications and for placement in the leaf whorls of maize and sorghum to control armyworms. Granules cannot be effectively applied to leaves, because they roll off. Furadan 3G is a granular formulation that contains 3 percent pure carbofuran.
- FUMIGANTS: These are available as pellets, granules, liquids, and gasses whose fumes kill pests. They are used to kill insects in stored grain or applied to the soil to kill insects, nematodes, and other pests.
- BAITS: These are usually the most effective formulations for controlling cutworms, crickets, slugs, and snails.

Cutworms are most effectively controlled with baits rather than with sprays. Baits should be scattered near the plants in the late afternoon if rainfall is unlikely. Bait should not be left in clumps which might poison birds or lives. One kg of bait should cover about 400 sq. meters.

Cutworm bait recipe:

25 kg of carrier (sawdust, rice bran, maize flour, etc.)
3 l of molasses
1 - 1.25 kg active ingredient of trichlorfon or carbaryl

Water can be added to moisten the bait.

Slugs and snails can be controlled by applying baits in the late afternoon in a band along the field's borders or within problem areas. It should not be applied if rain is expected that night, since rain may wash the insecticide from the bait.

Slug and snail bait recipe:

25 kg maize flour or bran
10 l molasses
65 g metaldehyde (a stomach poison of low-dermal toxicity) or 0.5 kg active ingredient trichlorofon or 0.5 kg active ingredient carbaryl

Chemical Classes Of Insecticides

Commercial insecticides fall into three main chemical classes or groups:

- Chlorinated hydrocarbons (organochlorines): Many of the insecticides in this group such as DDT, Aldrin, Endrin, and Dieldrin have very long residual lives and have caused environmental problems such as fish kills. However, other members such as Methoxychlor are readily biodegradable. Toxicity to humans and animals varies greatly within this group (see Appendix K).
- Organic Phosphates (organophosphates): The insecticides of this group such as Malathion, Dipterex, Diazinon, and Parathion have a much shorter residual life than most of the organochlorines. Their toxicity to animals and humans varies greatly. Some like Parathion, TEPP, Endrin, and Thimet are highly dangerous, while others like Malathion, Gardona, and Actellic are among the safest insecticides available.
- Carbamates: Relatively few insecticides belong to this group and they tend to be of moderate to low toxicity. The exceptions are carbofuran and methomyl which have very high oral toxicities. Carbaryl and propoxur are probably the best-known carbamates. The residual life of this group varies from short to moderate.

Insecticide Dosage Calculations

For all types of pesticides, there are four basic ways of stating dosages:

1. Amount of active ingredient (pure chemical) needed per hectare or acre.
2. Amount of actual formulation (i.e. Sevin 50 WP or Furadan 3 G, etc.) needed per hectare or acre.
3. Amount of actual formulation needed per liter or gallon of water.
4. As a percentage concentration in the spray water.

Types 1 and 2 dosages are suited more to large plots or to those pesticides (especially herbicides) needing very accurate dosage application.

Sprayer calibration is needed in both cases to determine how much water to use and how much pesticide to add to each tankful.

Types 3 and 4 are very general recommendations best suited to smaller plots or where dosage accuracy is not critical.

1. AMOUNT OF ACTIVE INGREDIENT NEEDED PER HECTARE: For example, a dosage might be given as 2 kg active ingredient carbaryl per hectare. This means 2 kg of pure (100%) Sevin. Since actual pesticide formulations vary in strength from 1 percent up to 95 percent, it takes some math to figure out how much of a given formulation is needed to supply a given amount of active ingredient. If the local agricultural supply store sells carbaryl 50 percent WP, the farmer would need 4 kg for each hectare in order to supply 2 kg active ingredient.

Note that nothing is said about how much water the farmer should mix with the pesticide when he sprays it on the plants. This will depend on plant size, plant density, and the degree of coverage desired. The only way to find out how much water is needed is to calibrate the sprayer.

2. AMOUNT OF ACTUAL FORMULATION NEEDED PER HECTARE OR ACRE: A recommendation calling for 4 l of Malathion 50 percent per hectare, for example, is somewhat simpler than Type 1 since it is given in terms of actual formulation rather than active ingredient. However, the farmer still needs to know how much formulation he needs for his field's area and how much water it will take to provide adequate coverage with his sprayer. This requires sprayer calibration.

3. AMOUNT OF ACTUAL FORMULATION NEEDED PER LITER OR GALLON OF WATER: If the recommendation is expressed as for example, 5 cc of Malathion 50 percent EC per 1 l of water, no sprayer calibration or dosage calculation is needed. The drawback is that the amount of pesticide the farmer actually applies on his field depends entirely on how fast he or she walks while spraying, how coarse or fine the spray is, and how much pressure is used. However, if proper guidelines are followed, Type 3 recommendations are precise enough for most conditions and are the most feasible for small farmers. They should not be used for most herbicides where accuracy of dosage is critical.

4. AS A PERCENTAGE CONCENTRATION IN THE SPRAY WATER: This is basically the same as Type 3, except that the concentration of pesticide in the spray water is given in terms of percent rather than cc/liter. Such recommendations are usually based on percentage by weight, although sometimes a volume basis is used when dealing with EC's (the actual differences are slight). The percentage figure given may refer to active ingredient or to actual formulation. As with

Type 3 recommendations, no sprayer calibration is needed, and dosage accuracy is not as good as with Types 1 and 2.

Pesticide Math

Converting recommendations from an active ingredient basis to an actual formulation basis.

Once you know how much actual formulation is needed per hectare or acre, you can easily calculate how much is needed for farmers' fields by multiplying the field size in hectares times the dosage per hectare.

Following a percentage strength spray recommendation:

Determine first whether the spray's percentage strength is to be calculated in terms of active ingredient or in terms of actual formulation. For example, one recommendation might be expressed as 2 percent strength spray in terms of pure Malathion.

Another recommendation might call for using a 0.1 percent strength spray of Lebaycid 50 percent EC for controlling thrips on peanuts.

- For wettable powders

When using WP's, a percentage strength spray is based on weight of pesticide to weight of water. Since 1 liter of water weighs 1 kg, these formulas can be used:

Active ingredient basis

Grams of wettable powder needed per liter of water $[2\% \times 1000]/40\% = 20/0.4 = 50\text{g}$

Actual product basis

Grams of wettable powder needed per liter of water
= % strength spray desired x 1000

- For liquids (EC's)

Active ingredient basis

cc (ml) of EC needed per liter of water
= [% strength spray desired x 1000] / % active ingredients in the EC

Guidelines for applying insecticides

When is Treatment Necessary?

Farmers should apply insecticides in response to actual insect problems rather than on a routine and indiscriminate basis. Ideally, insecticides should be used only when damage has reached the economic threshold. This level varies with the insect species, the crop, and the type and extent of damage.

General guidelines (see also the unit on major reference crop insects):

- Soil insects. These pests should be treated preventatively by making pre-planting or at-planting insecticide applications if a known problem exists. Treatments after planting are generally not effective except in the case of cutworm baits.
- Leaf-eating insects (beetles, caterpillars): Crops can tolerate considerable defoliation as long as new leaves are being continually produced. Loss of leaf area becomes more serious as the vegetative stage nears its end, although defoliation in the very late stages of grain development will not have a big effect on yield. Stem-borers usually cause more serious damage at much lower populations than most leaf-eating insects. The sorghum shoot fly, sorghum midge, and one species of bean leafhopper (*Empoasca kraemeri*) are other examples of insects that reach the economic threshold of damage at relatively low populations.
- Sucking insects: Not all species of aphids and leafhoppers spread virus diseases. For example, CIAT found that bean yields were reduced about 6 percent for each *Empoasca kraemeri* leafhopper present per leaf, even though this species does not transmit any viruses. Bean plants can tolerate aphids well unless they are of a species capable of transmitting common bean mosaic virus.

Using a Sprayer Effectively

Achieving the Correct Coverage

The extent and uniformity of coverage needed depend on the insects' location and whether or not a systemic insecticide is being used. In some cases such as armyworms feeding in the maize leaf whorl, the insect is very localized, so general coverage is not needed. Other insects are more general feeders and require thorough spray coverage over the whole plant. Since they are translocated, systemic insecticides do not require the uniform coverage non-systemics do.

The amount of water need for adequate coverage varies with plant size, density, type of product (systemics versus non-systemic), and insect location, but there are some rough guidelines:

Water rates for insecticides: When covering the entire foliage of full size plants, at least 500-550 l of water per hectare will be needed when using conventional sprayers. When spraying is localized or plants are very small, water volume may be only one-quarter of this amount.

Too much spray is being applied if there is a visible amount of runoff from the leaves, although this can also be caused by not using enough wetting agent (spreader).

Using a Spreader And Sticker

A spreader (wetting agent) reduces the surface tension of spray droplets, allowing them to spread out rather than remaining as individual globules on the leaf surface. Spreaders markedly improve the uniformity of spray coverage and also help prevent droplets from rolling off the leaves.

A sticker (adherent) is a glue-like substance that helps the spray stick to the leaf surface and resist being washed off by rainfall or sprinkler irrigation.

Many commercial stickers and spreaders are available, including combination sticker-spreaders. The pesticide label will indicate if a spreader or a sticker is needed. If spraying the soil, neither a spreader nor a sticker is needed. When spraying the leaf whorl of maize, a spreader is not needed, though a sticker might be helpful. Use of a sticker and spreader is especially important when applying most foliar fungicides.

Commercial stickers and spreaders are relatively cheap. However, if not available commercially, they can be made at home. Egg white, cassava (yuca, manioc) flour, and corn starch can be used as stickers at about 15 cc per 15 liters. Liquid dishwashing detergent makes a satisfactory spreader at about the same rate.

Non-ionic spreaders: Paraquat and diquat post-emergence herbicides are unusual in that they require the use of special non-ionic spreaders in order to avoid deactivation (loss of effectiveness). Ortho-77 is one commonly available non-ionic spreader.

Choosing a Spray Nozzle

Spray nozzles are available in a wide variety differing in output, spray pattern angle, and type of spray pattern. Proper nozzle selection has an important influence on pesticide effectiveness.

Spray Patterns

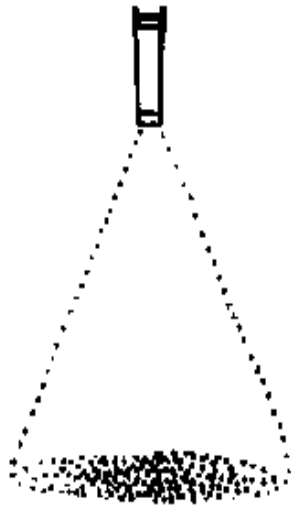

flat fan

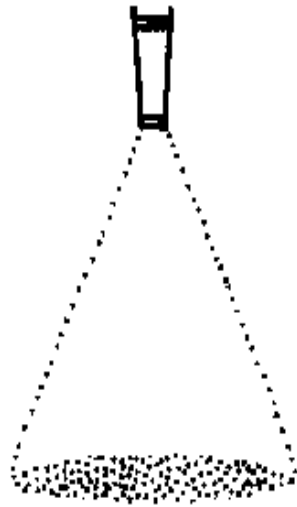

flat even



solid cone



hollow cone

Nozzle Output: Many backpack (knapsack) sprayers come equipped with adjustable nozzles which allow the farmer to vary the output by making the spray finer or coarser. This would seem to be an advantage, but such nozzles usually do not maintain their setting well and output can change considerably during application. This is unsatisfactory where accurate dosages are necessary, and it makes sprayer calibration difficult. Fixed orifice nozzles are available in a wide range of outputs and should be used whenever possible.

Tractor boom spray nozzle

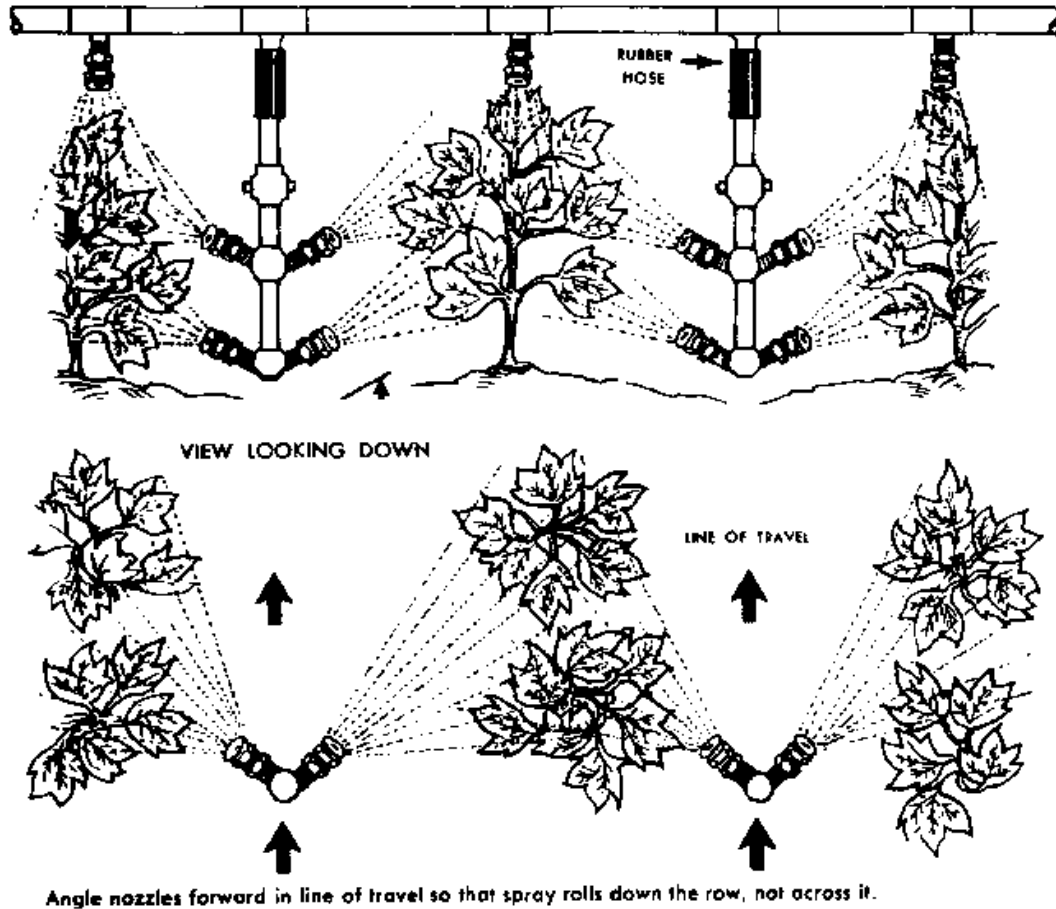

Illustration courtesy of Rohm & Hass Co., Philadelphia, Pennsylvania

Ideal tractor spray boom arrangement for applying insecticides and fungicides and achieving uniform coverage. Note that the drop nozzles are angled about 30° upward as well as 30° forward. Only one tier of "drop" nozzles may be needed on small- to medium-size crop plants.

Spray Pattern Angle: See flat spray

Type of Spray Pattern: Care should be taken to choose the right spray pattern for the job.

- Flat (Fan) Spray Nozzles are ideal for making broadcast (full coverage) applications of insecticides or herbicides over the soil surface (and small weeds). The application rate decreases at both edges, so the spray patterns of adjacent nozzles should be overlapped about three to four fingers width at the soil surface to achieve even distribution. Fan nozzles do not provide as good a coverage as cone nozzles when used to spray crop foliage. Fan nozzles are available in several different angles of spray width. Wider angles allow the spray boom to be carried closer to the ground and this lessens spray drift problems on windy days.
- Even Flat (Fan) Spray Nozzles should be used for making band applications of pesticides to the soil. Spray output does not decrease at the edges, so spray patterns should not be overlapped and used for broadcast applications.
- Solid Cone Spray Nozzles provide better coverage of plant foliage than fan nozzles but should not be used to apply herbicides and insecticides to the soil.

- Hollow Cone Spray Nozzles offer somewhat better foliar coverage than solid cone nozzles due to greater leaf agitation as the spray pattern passes over the plants.
- Whirlchamber (nonclog) Spray Nozzles are special wide angle hollow cone nozzles that can be used in place of fan nozzles. Their design reduces clogging, and drift is minimized because of the wide angle pattern (enabling lower boom height) and larger droplet size.

Nozzle Screens: Nozzles used on tractor boom sprayers usually have mesh or slotted strainers to help prevent clogging. Some backpack sprayers have strainers or can have them added on. Routine cleaning is required, especially when wettable powders are used.

Tips on Using Backpack Sprayers to Apply Insecticides

- Use good pressure and a fine spray. Pressure is too high if excessive spray drift (misting) occurs.
- Maintain a steady pace through the field. Avoid pausing at each plant unless the crop is very large.
- Rotate your wrist while spraying so that the spray hits the foliage from different angles.
- Keep the nozzle far enough away from the foliage so that the spray has a chance to spread out before hitting the leaves.
- If using a wettable powder, remember to periodically shake the sprayer to keep the pesticide in solution.
- Keep a piece of soft wire handy for cleaning out clogged nozzles, but use it gently to avoid damaging the nozzle opening.
- Do not spray plants when their leaves are wet or when rain is likely within a few hours afterwards.
- Do not add wettable powders or EC's directly to the sprayer tank. First mix them thoroughly in a bucket with several liters of water. Make sure wettable powders are completely dissolved.

Pesticide Compatibility

Most pesticides are compatible with each other in the spray tank, but check the label to make sure. In some crops like peanuts and vegetables, foliar insecticides and fungicides are often applied together. Spray compatibility charts are available from many pesticide companies.

Water with a pH of 8.0 or above (alkaline) causes a rapid breakdown of organic phosphate insecticides. Such high pH water is usually confined to limestone or low rainfall areas. Special buffering agents are available to lower the pH if necessary.

Certain insecticides are phytotoxic (injurious) to certain crops. Always check the label instructions. Wettable powder formulations tend to be less phytotoxic than emulsifiable concentrates, especially in temperatures over 32°C.

<u>Sorghum:</u>	<u>Trichlorfon causes severe injury. Azodrin and methyl parathion cause some injury.</u>
<u>Peanuts:</u>	Minor foliar injury which shows up as reddish brown spots on the earliest leaves is sometimes caused by soil applications of carbofuran, Thimet, and Disyston. The plants usually outgrow the damage with no yield reduction. Runner varieties on sandy soils are the most sensitive, and dosage should be reduced by 25 percent under these conditions.

Insecticide Recommendations For the Reference Crops

Particular pesticides are not recommended for the reference crops in this manual because of the potential misclassification of pest problems and misused pesticides. Rather than rely on this manual for pest

diagnosis and pesticide selection, it is recommended that you rely on the insecticide recommendations of your country's extension service if they are known to be effective and if they do not involve the use of high-toxicity Class 1 chemicals (see Appendix K). Before using any insecticide, refer to the safety guidelines and toxicity data in Appendix K. Always know the relative toxicity and environmental hazards of the products you use or recommend.

Disease control

Types of Diseases And Their Identification

Parasitic versus Non-parasitic Diseases

Parasitic diseases are caused by certain types of fungi, bacteria, and viruses that invade plants and multiply within their tissues.

Non-parasitic (non-infectious) diseases are caused by unfavorable growing conditions or other non-parasitic factors such as:

- Excesses, deficiencies or imbalances of soil nutrients
- Excessive soil acidity or alkalinity
- Temperature extremes
- Poor drainage or drought
- Mechanical, fertilizer or pesticide injury
- Air pollutants like ozone and sulfur dioxide.

Some of these non-parasitic conditions produce symptoms that can be confused easily with those of parasitic diseases.

Fungal Diseases

Fungi are actually tiny parasitic plants without roots, leaves or chlorophyll which feed on living or decaying organic matter. They reproduce and spread by means of microscopic seeds called spores. Some fungi, such as those that help break down crop residues into humus, are beneficial. Fungi can penetrate directly into seed, leaf or root tissue or can enter through wounds or natural openings. General types of fungal diseases are leaf spots leading to possible defoliation; rotting of seeds, stems, stalks, roots, grain heads, pods, and ears; and storage molds and wilts.

Diseases caused by fungi are by far the most common diseases of the reference crops because the spores are highly resistant to unfavorable conditions. They are spread easily by wind, water, soil, and farm implements, and some types can also be carried by the crop seeds themselves. Most fungal diseases develop and spread much more readily under high humidity and moisture. An important and common characteristic of fungal diseases is their ability to mutate to produce new races that are resistant to certain fungicides.

Bacterial Diseases

Bacteria are microscopic single cell organisms that multiply by cell division. Like the fungi, some bacteria are beneficial and perform essential functions like converting unavailable organic forms of soil nutrients to available inorganic (mineral) forms. Others invade plants and cause diseases that produce leaf spots, wilts, galls, and fruit and stem rots. For several reasons, bacterial diseases are generally much less prevalent than fungal diseases.

- Bacteria lack a resistant spore stage and are very dependent on favorable temperature and moisture conditions.
- Unlike the fungi, bacteria cannot forcibly penetrate into plant tissue but must enter through natural openings or wounds.

- Although bacterial diseases can be spread by wind-driven rain, field equipment, and certain types of insects (mainly some beetles), they are transmitted much less rapidly than fungal diseases.

Viral Diseases

Viruses are microscopic particles consisting of a core of nucleic acid (genetic material) surrounded by a protein coat. Viruses can multiply by diverting living host cells into the production of more virus particles and can also mutate to produce different strains. They are largely spread by sucking insects such as aphids, leafhoppers, and thrips. The relationship between these insect vectors (insect that transmit disease) and the viruses is sometimes very specific. For example, peanut rosette virus is transmitted by only one species of Aphid. Weeds are susceptible to certain viruses and serve as alternate hosts for viral diseases which are transmitted by sucking insects to crops.

Viruses usually do not kill plants, but can greatly reduce yields and quality. A wide variety of symptoms are produced such as leaf mottling (blotching), leaf curling, chlorotic (yellow) or necrotic (dead) spots on the leaves, leaf striping, and excessive branching.

How to Identify Plant Diseases

Some plant diseases can be identified readily by nonprofessionals right in the field. In other cases, however, accurate diagnosis requires a good deal of field experience or even the expertise of a trained plant pathologist and lab facilities. For more information on identifying plant diseases, see Appendix I, "Troubleshooting Common Crop Problems." Resources that give detailed descriptions of diseases of the reference crops can be found in the bibliography.

Methods of Disease Control and Effectiveness

Prevention versus Cure

Most diseases such as viruses and the bacterial and fungal rots of seeds, seedlings, roots, stalks, and stems cannot be controlled once they enter plant tissue. Fair to good control of fungal leafspots can be achieved with foliar fungicides but this is usually uneconomical with low value crops like maize, millet, and sorghum. Disease control methods are therefore geared much more toward prevention rather than cure.

Non-Chemical Disease Control Methods

- Resistant varieties: Disease resistance is a top priority among plant breeders. Breeders have located genetic sources of resistance to some of the more serious diseases, especially viruses and other types that lack effective or economical chemical control measures. However, resistance does not mean 100 percent immunity, and the ability of viruses and fungi to mutate into new races has posed some problems.
- Disease-free seed: Some diseases like bacterial blight and common mosaic virus of beans can be carried by the seeds. The use of certified seed that is disease-free is an important management practice in many bean-growing areas.
- Controlling host plants and insect vectors: This is especially important for controlling certain viral diseases and involves the removal of host weeds and other natural vegetation that serve as sources of infection. In some cases, non-susceptible barrier crops are planted around a field in a 15-20 m wide strip to "decontaminate" sucking insects before they reach the susceptible crop. (Usually not practical for the small farmer). Also included is the roguing (removal) of diseased crop plants attacked by viruses. However, roguing is not effective for most fungal and bacterial diseases.
- Crop residue management: The burning or plowing under of crop residues is an effective prevention method for a few diseases like Southern stem rot of peanuts.

- Other management practices: Several of these may help minimize certain disease problems: not cultivating plants while they are wet; avoiding crop injury at or before harvest; irrigating in the morning when sprinklers or hand watering are used so that crop leaves are dry at night; using raised beds to improve drainage and disinfecting tools.
- Crop rotation: This can reduce the incidence of many fungal and bacterial diseases, especially those that are soil-borne, but will have little effect on viruses. There is nothing wrong with monoculture from a disease standpoint as long as resistant varieties are being continually developed and introduced in response to new problems. However, this is unlikely in the developing countries.
- Intercropping: This practice may reduce or intensify disease problems, depending on the crop mixtures involved and whether they share some diseases in common.

Chemical Disease Control Methods

- Fungicides can be applied to seeds, the soil, and crop leaves and will provide fair to good control of certain fungal diseases. They are mainly applied as protectants.

Seed treatment with a fungicide dust or liquid will effectively prevent seed rots (pre-emergence "damping off") caused by soil fungi. This method will also kill any fungal diseases borne on the seedcoat surface such as loose smut and covered smut which attack adult sorghum plants.

Since seed treatments mainly protect the seed, they are not as effective at preventing seedling blights (rots) and seedling root rots. A systematic seed treatment fungicide called Vitavax (Carboxin) gives somewhat better control.

Seed treatments will not control any soil-borne or airborne fungal diseases that attack older plants such as leaf spots, stalk rots, stem rots, and root rots.

Fungicide applications to the soil are sometimes helpful. Some fungicides like PCNB (Terrachlor), Vitavax (Carboxin), and Benlate (benomyl) can be applied as sprays or dusts to the seed furrow or to the row during crop growth to control certain fungal stem and root rots.

Such soil applications are seldom necessary or economical for maize, sorghum, and millet, but can be profitable on high-yielding peanut and bean crops where disease problems exist.

Foliar fungicides can be applied as dusts or sprays to crop foliage to control fungal leaf spot diseases. Most foliar fungicides act as protectants to help prevent the occurrence or spread of leaf spots. Some of the recently developed systemic fungicides like Benlate (benomyl) and Mertect (Thiabendazole) also have erradicant properties.

Most foliar fungicides have little or no effect on bacterial leaf spots, but copper base fungicides provide fair to good control.

Foliar fungicides are usually-not economical for maize, sorghum, and millet, but are often essential for control of Cercospora leaf spot in peanuts and can be very profitable in this case. Their use on beans may be justified where yields are in the medium to high range and fungal leaf spots become serious.

- Soil sterilants like methyl bromide, formaldehyde, Basamid, and Vapam will control soil fungi, bacteria, insects, weeds, and nematodes. They are applied in advance of planting and allowed to disperse before the seeds are sown. Soil sterilants are frequently used on seedbeds for growing tobacco and vegetable transplants, but are too expensive for use with the reference crops.
- Antibiotics like Streptomycin and Terramycin are bactericides used as foliar sprays or transplant dips to control certain bacterial diseases. Other antibiotics like Kamusin (Kasugamycin) and Blasticidin are effective against certain fungal diseases such as rice blast, and are widely used in Japan. Their high

cost makes them uneconomical for use on the reference crops. There are several problems associated with antibiotics, namely residues, the development of resistant races of fungi and bacteria, and occasional phytotoxicity.

- Use of insecticides to control insect vectors: Is seldom completely effective since 100 percent control is impossible.

Integrated Disease Control

Integrated disease control involves the combined use of non-chemical and chemical methods. Except for the mercury base fungicides sometimes used as seed dressings, the fungicides pose few toxic or environmental threats, unlike some insecticides. The incentive for integrated disease control is based on economics and the fact that many diseases cannot be controlled adequately with chemicals.

Major diseases of the reference crops

Maize

Maize Fungal Diseases

Seed Rots and Seedling Blights

These are often referred to as pre-emergence and post-emergence "damping off" and are caused by soil- or seed-borne fungi. Seeds may be killed before germination or seedlings may be destroyed before or after they emerge from the ground. Damping off is most prevalent in cold, poorly-drained soils and with damaged seed (cracked seedcoat, etc.). Problems are less likely where conditions favor rapid germination and emergence (i.e. warm weather, adequate soil moisture).

Symptoms: Above-ground signs are yellowing, wilting, and death of the seedling leaves, but this can be confused easily with injury by wind, wind-blown sand, fertilizers, herbicides, and insects. Examine the below-ground portion of the plants and look for rotted seeds, soft rot of the stems near the soil surface, and rotted, discolored roots.

Control: Use good quality seed, free of molds and damage, that has been treated with a fungicide like Captan or Arasan (thiram) for protection during germination. Seed treatment is mainly effective against seed rot.

Helminthosporium Leaf Blights

Several species of Helminthosporium fungi attack maize leaves, but the two most important are H. Maydis (Southern leaf blight) and H. turcicum (Northern leaf blight). Helminthosporium maydis is more prevalent in hot, humid areas, but both species can occur on the same plant.

Symptoms of H. Maydis: There are two major races of H. maydis and they have different symptoms. Race "O" leaf spots are small and diamond-shaped when young and then elongate to about 2-3 cm and may grow together, killing large areas of leaf. Race "T" leaf spots are oval and larger than those of race "O" and attack the husks and leaf sheaths, unlike race "O". Maize hybrids utilizing "Texas" male sterile cytoplasm (genetic material) in their production are very susceptible to race "T". This became evident during the severe and unexpected outbreak of H. maydis race "T" in the U.S. Corn Belt in 1970. Most hybrids now utilize "N" male sterile cytoplasm in their production to overcome this problem.

Symptoms of H. turcicum: Northern leaf blight prefers high humidity and low temperatures. Small, slightly oval, water-soaked spots first appear on the lower leaves and eventually become rectangular in shape and grow to a length of 2.5-15 cm. These lesions are grayish-green to tan and can cause severe defoliation.

Control: Resistant varieties offer the best protection. Seed treatment with a fungicide is of no help. Foliar fungicides give fair to good control but are seldom economical since they must be applied every 7-10 days,

Maize Rusts

Three types of rust attack maize: common rust (Puccinia sorghi), Southern rust (Puccinia polysora), and tropical rust (Physopella zeae).

Common rust occurs more frequently in cool, moist weather and produces small, powdery, cinnamon-brown pustules on both surfaces of the leaves. Southern rust is more common in warm humid regions and produces smaller, lighter-colored pustules than common rust. Tropical rust is confined to the tropical regions of Latin America and the Caribbean. The pustules vary in shape from oval to round and occur beneath the leaf epidermis (outer layer). They are cream colored and very small and are sometimes surrounded by a black area.

Control: Resistant varieties are the best protection. Fungicide sprays are seldom economical.

Maize Downy Mildews

At least nine species of Sclerospora (Sclerophthora) fungi attack maize. At present, they are mainly confined to parts of Asia and Africa, but also appear to be spreading throughout the Americas.

Symptoms vary with the species, age of plants when infected, and the climate, but usually include chlorotic striping of the leaves and leaf sheaths, stunting, excessive tillering, and deformities of the ears and tassels. A downy growth (mildew) may occur on the undersides of the leaves in later stages. Some of these symptoms may be confused with viruses.

Some of the more common downy mildews are listed below with their control measures:

Crazy Top (S. macrospora): Rare in the true tropics but of world-wide distribution in temperate and warm-temperate climates. Crazy top causes the tassel to mutate into a mass of leafy bunches and is provoked by one or more days of flooding before seedlings have reached the four to five leaf stage. Adequate soil drainage is the only control.

Sorghum Downy Mildew (S. Sorghi): Widespread.

Controls: Using resistant varieties, removing and destroying infected plants, and avoiding maize-sorghum rotations in infected fields.

Green Ear Disease or Graminicola

Downy Mildew (S. graminicola): Occurs on various grasses but is usually not important in maize.

Sugarcane Downy Mildew (S. sacchari): Mainly confined to Asia and the South Pacific.

Controls: Eliminating the disease by using healthy planting material, growing maize in areas free of the disease and where sugarcane is not grown extensively, removing and destroying infected plants, and using resistant varieties. Fungicide sprays are used in some areas.

Philippine Downy Mildew (S. philippinensis): This is the most important maize disease in the Philippines and also occurs in Nepal, India, and Indonesia.

Controls: Removing and destroying infected plants, using resistant varieties and fungicide sprays where economical.

Common Smut and Head Smut

Common smut (*Ustilago maydis*): A fungus that causes galls (swollen areas on plant tissue) 1520 cm in size which form on any above-ground part of the plant. When young, the galls are shiny and whitish with soft interiors, but later turn into a mass of black, powdery spores. Early infection can kill young plants, but common smut is seldom a serious problem.

Controls: Using resistant varieties and avoiding mechanical injury to plants. Good soil fertility is helpful. Galls should be removed from plants and burned before they rupture.

Head smut (*Sphacelotheca reiliana*): Can seriously affect yields in dry, hot regions. This is a systemic fungus that enters seedlings without showing symptoms until the tasseling stage. Tassels and ears become deformed and develop masses of black, powdery spores. Head smut is mainly a soil-borne disease.

Controls: Most varieties are resistant. Crop rotation and general sanitation also provide some control. Soil applied fungicides in the seed row give fair to good control, but are usually not economical. Seed treatment with a fungicide is ineffective.

Fungal Stalk Rots

Five of the more common fungal stalk rots are discussed below. They attack plants between tasseling and maturity, although Pythium stalk rot may also infect younger plants. Diplodia stalk rot: Most likely to occur several weeks after pollination. The leaves suddenly wilt and die, turning a dull grayish-green, and the stalk dies 7-10 days later. Numerous small, raised, black dots can be seen on the lower internodes of the stalk. Infected portions break readily and can be easily crushed. Diplodia infected stalks usually break between the joints (nodes).

Controls: Using resistant varieties, avoiding high rates of N fertilizer without adequate K, and lower plant populations.

Gibberella stalk rot: Similar to Diplodia except that the stalks tend to break at the joints, and the inside of the stalk is pinkish-red. The small black dots found on the lower portion of the stalk can be scraped off with a fingernail, unlike those of Diplodia.

Controls: See Diplodia.

Fusarium stalk rot: Similar to Gibberella and difficult to distinguish from it.

Controls: See Diplodia.

Pythium stalk rot: Most likely to occur during long periods of hot, humid weather. Usually attacks a single internode near the soil surface and causes a brown, soft, water-soaked rot that collapses the stem. Stems do not break off but fall over, and plants may remain green for several weeks afterwards. Pythium usually occurs around tasseling time but may also affect younger plants. It is easily confused with Erwinia bacterial stalk rot.

Controls: Using resistant varieties.

Charcoal rot (*Macrophomina phaseoli*) Attacks maize, sorghum, soybeans, beans, cotton, and others, It is most prevalent under very hot, dry conditions and first attacks seedling roots where it produces brown, water-soaked lesions which eventually turn black. The fungus usually does not invade the stalk until well after pollination when it causes the lower internodes to ripen prematurely and shred, causing breakage at the base of the plant, The inner stalk has a charred appearance due to the presence of numerous black dots (sclerotia).

Controls: Charcoal rot can be reduced in irrigated fields by maintaining a good soil moisture content during dry spells after tasseling; see also Diplodia.

Fungal Ear and Kernel Rots

Maize can be attacked by a number of ear and kernel rots, especially when very wet weather occurs from silking to harvest. Insect and bird damage of stalks and ears also increases susceptibility.

Diplodia ear rot: Causes early-infected ears to have bleached husks, while normal husks are still green. Ears are shrunken, and the husks seem to be glued together due to the fungus growing in-between. Ears infected later in the season seem normal from the outside but have a white mold that usually starts at the base of the kernels. In severe cases, black fruiting bodies can be seen on the husks and on the sides of the kernels.

Controls: Ears that mature with the tips pointed downward are less susceptible. Good husk covering is also helpful as is an early harvest and proper storage at a safe moisture content.

Gibberella ear rot (G. zeae): More prevalent in cool, humid areas and causes a pink to bright red rot starting at the ear tips. G. fujikuroi is the most common ear rot worldwide and is similar in appearance. Both types also produce a cotton-like pink growth over the kernels, and infected grain is toxic to humans, pigs, and birds.

Controls: See Diplodia

Fusarium ear rot: Favored by dry, warm weather and similar to Gibberella. Nigrospora ear rot: Causes the cob to be discolored and easily shredded. The interior is gray instead of white. Kernels are poorly filled and can be easily pushed into the partially rotted cob. Spore masses in the form of black spots are found at the base of the kernels.

Controls: Balanced soil fertility; see Diplodia.

Maize Bacterial Diseases

Erwinia stalk rot: Causes symptoms similar to Pythium (see fungal stalk rots).

Controls: Using resistant varieties and good drainage.

Bacterial leaf blight (Stewart's wilt): Transmitted by certain types of maize beetles and by the seed. Sweet maize is more susceptible. Symptoms are pale green to yellow streaks on the leaves, usually appearing after tasseling. The streaks die and may kill the leaf. The stem may also become infected, leading to wilting of the plant.

Controls: Using resistant varieties, early use of insecticides to control insect vectors.

Maize Viral Diseases

Maize is attacked by some 25 virus or virus-like diseases which are transmitted mainly by aphids and leafhoppers. Alternate host plants like Johnsongrass, sorghum, and sugarcane play an important role in the spread of most of them, Symptoms can be confusing and may often be caused by other problems such as nutrient deficiencies. Some of the more prevalent viruses are dealt with below:

Maize streak virus: A major problem in many areas of Africa and transmitted by several species of leafhopper (Cicadullina spp.). Early signs are tiny round scattered spots on the youngest leaves which enlarge parallel to the leaf veins. Broken yellow streaks later appear and run along the veins.

Controls: Resistant varieties; leafhopper control.

Maize dwarf mosaic: Spread by several types of aphids and a wide range of alternate hosts, including Johnson-grass (a sorghum relative) and sorghum. Leaves of infected plants develop a yellow-green

mosaic pattern, mainly on the bases of the younger leaves. Foliage becomes purple or purple-red as plants mature, severe stunting may occur, and few plants produce normal ears.

Controls: Using resistant varieties. Destruction of alternate hosts and insect control.

Maize stunt virus: Spread by several types of leafhopper (Dalbulus, Baldulus, Graminella) and known as "achaparramiento" in Latin America. Now thought to be a virus-like organism. The Mesa Central strain causes yellowing of the young leaves which later turn red. The Rio Grande strain produces spots at the bases of young leaves, followed by a yellow striping.

Controls: Resistant varieties; insect control.

Sugarcane mosaic: Occurs where maize is grown next to sugarcane and causes yellow spots and streaks.

Controls: Using resistant varieties of sugarcane.

Sorghum

Fungal Diseases

Seed rots and seedling blights: See maize.

Downy mildews: Sorghum is attacked by three species of downy mildew (S. macrospora, S. sorghi, S. graminicola). (Refer to maize for details).

Controls: Using resistant varieties and rotation with broad-leaf crops. Many forage-type sorghums are very susceptible to sorghum downy mildew (S. sorghi) and should not be planted on ground where grain sorghum will be sown if the disease is present.

Covered kernel smut (Sphacelotheca sorghi): Carried by the seed and penetrates the young seedlings. Plants appear normal until heading time when the kernels are replaced by light-gray or brown, cone-shaped smut galls full of black spores.

Controls: Seed treatment with a fungicide is very effective since the spores are carried on the surface. Resistant varieties have been developed.

Loose kernel smut (S. cruenta):

Very common in Asia and Africa. As with covered smut, the spores are carried on the planting seed and invade young seedlings. Long, pointed smut galls are formed on the grain heads, and infected plants may be stunted and show increased tillering. Unlike covered smut, loose smut spores may cause infections of late emerging grain heads on otherwise healthy plants.

Controls: Same as for covered smut.

Head smut (S. reiliana): The most damaging of the smuts. Destroys the entire head and replaces it with a mass of dark brown, powdery spores. A large gall covered with a whitish membrane bulges out of the boot at heading time. The gall ruptures and spores are scattered by wind and rain over the soil where they survive to infect the next crop.

Controls: Seed treatment will prevent the spread from field to field, but will not stop infection from spores already in the field. Resistant varieties should be used and infected plants removed and burned.

Grain (Head) Molds

These are caused by several species of fungi that are most prevalent when sorghum matures during wet weather. Seed becomes heavily molded and will germinate poorly if planted. Controls: Photo-sensitive varieties escape head mold by maturing during drier weather. Other types can be sown to mature during drier weather. Open-headed varieties are somewhat less susceptible than those with compact heads. Work in India has shown that head molds can be reduced by spraying the heads with Captan or Benlate (benomyl) plus a sticker immediately after a heavy rain, but this may not be cost effective.

Sorghum Rust

This is caused by the fungus Puccinia purpurea which produces raised brownish pustules on both sides of the leaves. This disease is most common under high humidity but is usually confined to the older, mature leaves.

Controls: Using resistant varieties. Fungicides are not usually economical.

Anthracnose

This disease is caused by the fungus Collectotrichum graminicola which attacks the leaves, producing tan to reddish lesions that are round to oval and have soft, sunken centers. It may also cause a stalk rot called red rot.

Controls: Using resistant varieties.

Other Fungal Leaf Spots

Sooty stripe (Ramulispora sorghi), zonate leaf spot (Gloesocercospora sorghi), and oval leaf spot (Ramulispora sorghicola) are the main fungal leaf spots in West Africa, along with anthracnose.

Controls: Resistant varieties offer the best means of control. Removal of host plants like Guinea-grass, Bermudagrass, and Paragrass helps.

Fungal Stalk Rots

Charcoal rot (Macrophomina phaseoli see maize): A serious disease of dryland sorghum. Losses are increasing in India, Ethiopia, Tanzania, and Upper Volta. It is the most serious sorghum disease in Nicaragua and also causes serious losses in Mexico and Colombia. Charcoal rot is especially severe when grain filling takes place during high soil temperatures and drought.

Controls: See maize. Milo disease (Periconia circinata): Presently confined to the U.S. and attacks the roots as well as the stalks. Even young plants may be affected. The first symptoms are stunting and slight leaf rolling. The tips and margins of older leaves turn light yellow, and all the leaves eventually become affected. Splitting the base of the stalk lengthwise reveals a dark red discoloration in the center. Roots are also dark red.

Controls: Resistant varieties.

Red stalk rot (Collectotrichum graminicola): The stalk rot phase of anthracnose. The outside basal portion of the stalk becomes red or purple. If the stalk is split lengthwise, the inner pith shows a reddish discoloration which may be continuous or blotchy. The flower stem may be similarly affected.

Controls: See anthracnose.

Bacterial Diseases

Several bacterial leaf diseases attack sorghum and are favored by warm, humid weather. Yield losses usually are not serious. Seed treatment with a fungicide, crop rotation, and resistant varieties are the best controls.

Sorghum Viral Diseases Maize dwarf mosaic and sugarcane mosaic produce very similar symptoms on sorghum. The mottled light and dark green mosaic pattern is usually most prevalent on the upper two to three leaves and often includes longitudinal white or yellow streaks. Varieties with a red pigment may show a "red leaf" symptom consisting of red stripes with dead centers. Controls: see maize. Yellow sorghum stunt: A virus-like organism that is spread by leafhoppers. Plants become dwarfed with leaves bunched together at the top. Leaves develop a yellow cream color.

Controls: Resistant varieties; insect control.

Millet

Downy mildew (Sclerospora graminicola): Can attack millet as early as the seedling stage. The systemic fungus causes the leaves to become yellowish and under wet conditions a downy white mildew may occur on the undersides of the leaves. Affected seedlings may die within a month without producing any tillers. The symptoms may first appear on the upper leaves of the main stem or on the tillers. The first leaf affected normally shows damage only on the lower portion, but subsequent leaves suffer increasing infection. Heads may be partially or totally deformed.

Control: Many local varieties have good resistance. The International Crops Research Institute for the Semi-Arid Tropics (ICRISAT) achieved excellent control of downy mildew by treating planting seed with a newly developed systemic fungicide from Ciba Geigy known as GCA 48/988.

Grain smut (Tolyposporium penicilliriae): Fungi infect the young millet florets on the seed head and replace them with plumb galls full of black powdery spores.

Controls: Use resistant varieties and general sanitation. Seed treatment with a fungicide is probably not very effective.

Ergot (Claviceps fusiformis): Common, but generally not serious. The airborne fungal spores infect the young florets before grain development and produce a sweet sticky liquid called honeydew, which is pink or red. The grain head later takes on a bottle-brush appearance due to the formation of dark-colored hard structures called sclerotia

Controls: Burn infected heads.

Rust (Puccinia penniseti): Sometimes serious on late millet but usually not with early millet.

Leaf spots: Several fungal leaf spots attack millet but are usually not serious.

Peanuts

Foliar Fungal Diseases

Foliar fungal diseases can seriously reduce yields of both nuts and hay, and the decaying fallen leaves provide organic matter for incubating soil-borne diseases like Southern stem rot.

Cercospora Leafspot: Attacks peanuts worldwide, but Virginia types (see Chapter 3) are somewhat less susceptible than the Spanish-Valencia types. It is encouraged by wet conditions.

Symptoms: Two species of Cercospora fungi are involved. Early leafspot (C. arachidicola) is usually the first to appear and produces round, brownish-red spots surrounded by a yellow halo. Late leafspot (C. personata) occurs later in the season and produces darker spots that may or may not have halos. Both leafspots may also occur on the stems and leaf petioles (leaf stems) as the disease progresses. Severe defoliation can result, which affects yields as well as the performance of mechanical pullers, which require bulky bushes for satisfactory operation.

Controls: Crop rotation helps reduce early infections. Even though Virginia types show some resistance, foliar fungicides are usually essential in most cases and are applied as preventatives. Peanuts are a relatively high value crop, which makes use of foliar fungicides very economical. Specific recommendations are given in the next unit.

Peanut Rust (Puccinia arachis): This disease is presently confined to Latin America and the Caribbean. It causes small orange to brown raised pustules on the leaves, mainly on the undersides. It can spread rapidly under hot, humid conditions, and leaf drop can be severe. The stems, petioles and pegs can also be affected.

Controls: As with leafspot, fungicide sprays or dusts are the only effective control.

Ground Diseases

Ground diseases caused by fungi are sometimes hard to detect and identify and can drastically reduce yields.

Southern Stem Rot: Also known as Southern Blight, wilt and white mold, it is the most serious and widespread ground disease attacking peanuts and also affects beans, soybeans, other legumes, potatoes, tomatoes, and other crops. It is favored by warm, wet conditions.

Symptoms: In the early stages, some of the leaves on a few branches usually turn yellowish. Under wet conditions, a white cotton-like mold occurs on the lower stem near the soil surface and on any decaying organic debris on the soil. Fungal bodies called sclerotia appear on the affected areas and are light brown to brownish red and about the size of mustard seeds. The leaves begin a gradual wilt, but at first seem to recover at night. Eventually, the entire plant can die. The pegs are destroyed, leaving many pods imbedded in the ground. The disease can also cause pod rot.

Controls: There is no way to control this disease once plants are affected, but it can be effectively suppressed through a combination of chemical and cultural controls given below:

- Crop rotations with maize, sorghum, and other grass family plants.
- Deep burial of all crop residues using a moldboard plow. Coarse trash like maize and sorghum stalks need to be chopped up manually or with a disk harrow before plowing. Residues left on the surface serve as a breeding ground for the fungus.
- Planting peanuts on a flat field or on a ridge. Seed furrows should not have depressions which cause poor drainage.
- Avoiding cultivation which throws soil into the crop row, especially when plants are young. This can cause stem injury and burial of young plants, which greatly increases susceptibility to stem rot and crown rot.
- Control of Cercospora leafspot and other foliar diseases with fungicides to minimize defoliation, since fallen leaves also serve as breeding grounds for the fungus.
- Applications of soil fungicides like PCNB (Terrachlor) and Vitavax (Carboxin) in a band over the row at planting or at early pegging stage. These give fair to good protection where stem rot problems are serious. (See the next unit for specific recommendations.)

Seed Rot and Seedling Blight (Pre- and Post-Emergence "Damping Off")

Pre-emergence rot: It is not unusual to find germinating peanut seeds rotting in the ground. Affected seeds break down rapidly, but early examination will show them to be covered with a growth caused by various species of fungus.

Seedling blight is often referred to as Aspergillus crown rot and is caused by Aspergillus niger, a black sooty fungus. True crown rot is more accurately used to describe the disease when it attacks older plants past the seedling stage. The stem tissue just below ground level is attacked on young seedlings shortly after they emerge, and the fungus quickly spreads up the stem, covering it with a mass of black spores. The stem will then suffer a total collapse.

Contributing factors: Soils that have been continually cropped to peanuts for long periods have more problems with seed rots and seedling blights. Excessively deep planting weakens the stem and increases susceptibility. Seeds may also be damaged as they are being deshelled.

Controls: Seed treatment with fungicides gives good control; usually a combination of two fungicides is needed to provide control of all species. Recommendations are given in the next unit. Attention should also be given to planting depth and crop rotation.

Sclerotinia Blight

This is somewhat similar but less common. Affected plants have a white fungal growth attached to rotted areas of the stem which may extend from below the soil surface up into some or all of the individual runners. Infected stem tissue is very shredded and contains many black fungal bodies. Pegs and nuts are also attacked. Control is usually not needed, but a fungicide called Botran (dicloran) is sometimes applied as a spray in the U.S.

Peg and Pod Rots

Several types of fungi including Sclerotium and Sclerotinia attack the pegs and pods. Soil sterilants are sometimes applied before planting in the U.S., but this would seldom be economical or feasible for small farmers. Crop rotation is helpful.

Aspergillus flavus is a fungal mold that attacks stored seed but is sometimes found in the field. Under certain conditions, some strains of A. flavus produce aflatoxin, a potent carcinogen (cancer-causing agent) and toxin that can affect birds, humans, and other mammals. Harvested pods are free of aflatoxin except where they have been broken or damaged by termites, hoeing, threshing or rough handling. The development of Aspergillus and other storage molds largely can be prevented by timely harvest, separation of damaged kernels, and rapid drying of moist pods.

Viral Diseases

Rosette virus: The most serious disease of peanuts in Africa, especially in the wetter areas. It is spread by one species of aphid (Aphis craccivora) and has several alternate host plants, including Euphorbia hirta, a weed. Plants become severely stunted, and the younger leaves turn yellow and mottled. Emerging leaves remain small and become curled and yellow. Early planting and close spacing appear to reduce the incidence of rosette virus. Affected plants should be removed and destroyed, and aphid control should be considered.

Destruction of alternate host plants is helpful. Resistant varieties have been developed in Senegal.

Spotted wilt virus: Caused by tomato wilt virus and spread by several types of thrips. Affected plants have leaves with light green and yellow patterns, often in large patches or in the form of ring spots. Leaves are usually misshapen and puckered, and the plants take on a bunched appearance. Tomatoes, potatoes, lettuce, peppers, ornamental plants, and several types of weed serve as alternate hosts. It is usually not serious.

Beans

Seed-Borne Diseases

Beans suffer heavy disease losses worldwide, and one of the major reasons is the high prevalence of seed-borne diseases. According to CIAT, more than half of the major bean diseases can be transmitted by the seed; these include anthracnose, damping off, root and stem rots, bacterial wilt, bacterial blight, and several viruses. Disease-free certified seed is very difficult to obtain in Latin America and presently makes up less than 3 percent of the bean seed planted there.

Control of seed-borne fungi: Many fungi are carried on or in the seed coat, and seed treatment with conventional fungicides like Arasan (thiram) and Captan (Orthocide) will control them. Others like anthracnose are carried deeper in the seed and are usually unaffected by seed treatment. Systemic fungicides like Benlate (benomyl) have shown some promise in these cases. Foliar applications of systemic fungicides during the latter half of the growing season have significantly reduced the incidence of seed-borne anthracnose in the harvested seed, but are expensive. Delayed harvesting and pod contact with the soil surface during growth can increase seed-borne disease problems.

Control of seed-borne bacteria: Seed treatments will not control internally-borne bacterial diseases on beans. Seed produced in drier areas using strict sanitary and cultural practices such as crop rotation and inspection is less likely to be contaminated.

Control of seed-borne viruses: Current seed treatments are ineffective against seed-borne viruses. Control involves the production of disease-free seed in areas where vectors and hosts can be controlled.

Fungal Diseases

Pre-Emergence Rot: Seed treatment with fungicides is very effective. (See maize and peanuts.)

Root Rots: Beans are very susceptible to root rots caused by Rhizoctonia, Fusarium, Sclerotium, and other fungi. Symptoms include reddish or brown lesions on the hypocotyls (below-ground portion of the stem) and rotting of the lateral roots from one to several weeks after emergence. Wilting and leaf yellowing may or may not occur.

Controls:

- In temperate areas, planting only after soils have warmed up
- Good drainage
- Crop rotation
- Avoiding contamination of virgin ground with unclean tools, animal or green manure containing bean residue or dirty irrigation water.
- Treating seed with Arasan (thiram), Zineb, Demosan, PCNB, Vitavax (carboxin) or Benlate at 1-3 active ingredient per kg to give partial control.
- Applying Benlate or PCNB over the seed furrow after planting to give good control.

Anthracnose (*Colletotrichum lindemuthianum*): Anthracnose is of worldwide importance in cool to moderate temperatures and wet conditions and is spread by seed, soil, crop debris, rain, and tools. It produces elongated reddish-brown to purple cankers on stems and leaf veins. Pods have sunken spots with pink centers and darker borders. Infected seeds may be discolored and have dark brown to black cankers. Anthracnose is seldom a problem in hot, dry areas.

Controls:

- Use disease-free seed.
- Do not grow beans more than once every two or three years on the same field (includes cowpeas, lima beans).

- Avoid working in fields when the plants are wet.
- Plow under bean residues.

Seed treatment with fungicides is only partially effective. Preventative applications of foliar fungicides have variable results.

Rust (*Uromyces phaseoli*): Rust is of worldwide distribution and also attacks cowpeas and lima beans. Losses are heaviest when plants are infected at or before flowering. The disease is favored by damp weather and cool nights and can infect both the leaves and the pods. First symptoms usually appear on the lower leaf surface as whitish, slightly raised spots. The spots grow into reddish-brown pustules which may reach 1-2 mm in diameter within a week. The entire leaf begins to yellow, then turns brown and dies. Rust is not carried on the seed, but the spores persist in bean residues. There are many races of rust, and bean varieties vary in their resistance to them.

Controls:

- Crop rotation.
- Sulfur dust or fungicide sprays (see next section).

Angular Leafspot (*Isariopsis griseola*): This disease causes gray or brown angular lesions on the leaves which eventually lead to premature defoliation. Pods may be affected with oval to round spots with reddish-brown centers and seeds may be shrivelled. The disease is carried by the seed, but contaminated plant debris is a much more common source of infection.

Control: Using disease-free seed, crop rotation, and removing previously infected crop debris from the field before planting. Seed treatment with a fungicide (Benlate has given good results) and fungicide sprays may help.

Sclerotinia Blight (white mold): Causes water-soaked lesions and a white mold on leaves and pods (see also peanuts). It can be controlled by crop rotation and foliar sprays of Benlate, Dichlone, Dicloran, PCNB or Thiabendazole around early to mid-bloom. Irrigation intensifies this disease.

Web Blight (*Thanatephorus cucumeris*) This disease can be a major limiting factor to bean production under high temperature and humidity. Many other crops are also affected. The fungus causes small round water-soaked spots on the leaves which are much lighter than the surrounding healthy tissue and look like they have been scalded. Young pods show light tan spots that are irregular in shape but become darker and sunken with age--they can be confused with anthracnose. The stems, pods and leaves become covered with a spider web-type growth that is imbedded with brown fungal bodies. Web blight can be carried by the seed but is more commonly transmitted by wind, rain, tools, and the movement of humans and draft animals through the field.

Controls:

- Disease-free seed.
- Crop rotation with maize, grasses, tobacco, and other non-hosts.
- Planting beans in rows, not by broadcasting, to maximize air circulation.
- Fungicide sprays give fair to good control. Systemics like Benlate are recommended under high rainfall.

Bacterial Diseases

Common Blight (*Xanthomonas phaseoli*) and Fuscous Blight (*Xanthomonas phaseoli* var. *fuscans*): Both diseases produce the same symptoms on leaves, stems, pods and seeds. The first leaf symptoms are water-soaked spots on the undersides which grow irregularly and are surrounded by a narrow zone of

lemon yellow tissue. These spots eventually become brown and dead. The stem may become girdled near the soil and break. Water-soaked spots form on the pods, gradually enlarge and become dark, red and somewhat sunken. Infected seed may rot and shrivel.

Controls:

- Disease-free seed.
- Crop rotation and deep plowing.
- Copper-base fungicides have controlled leaf symptoms well, but have not given good yield increases. Antibiotics should not be used due to the danger of causing mutations.
- Seed treatment is not very effective.
- Some varietal resistance is available.

Halo Blight (Pseudomonas phaseoli-cola): This bacterial disease prefers cooler temperatures than common and fuscous blights. The initial symptoms are small, water-soaked spots on the undersides of the leaves, which eventually become infected with greasy spots if the attack is severe. Stem girdle or joint rot occurs at the nodes above the seed leaves when the disease results from contaminated seed. However, leaf yellowing and malformation may occur without many other external signs.

Controls:

- Deep plowing and crop rotation
- Removing infected plant debris from the field
- Avoiding work in the fields when the foliage is wet
- Disease-free seed
- Varieties that have some resistance
- Seed treatment with Streptomycin (2.5 g active ingredient per kilogram of seed) or Kasugamycin (0.25 g active ingredient per kilogram), using the slurry (liquid) method.
- Copper-base fungicides applied to the leaves gives poor to fair control.

Viral Diseases

Beans are attacked by a number of viruses, many of which also attack cowpeas. Bean common mosaic, bean yellow mosaic and cucumber mosaic viruses are spread by aphids.

Bean rugose mosaic and several others are spread by beetles. Bean golden mosaic and chlorotic mottle viruses are spread by white-flies, and curly top virus by the beet leafhopper. Symptoms include one or more of the following: green-yellow leaf mottling, leaf malformation, puckering, curling, plant stunting, and yellowing. Control consists largely of using resistant varieties and disease-free seed, and controlling insects.

Non-Parasitic Diseases

Seed injury: Bean seed is very susceptible to seedcoat damage and internal injury by improper threshing and mechanical harvesting or by rough handling. Damage may be invisible or produce cracks in the seedcoat, both of which can cause the following seed abnormalities:

- Reduced germination and seedling vigor: This can also be caused by bacteria, fungi, insects, fertilizer burn, and herbicide injury.

- "**Baldhead**": The seedling lacks a growing point. There is only a bare stump above the cotyledons, so no further leaf growth can occur.
- **Detached cotyledons**: Young bean seedlings need at least one complete cotyledon or two broken ones with more than half attached to provide adequate nutrition for emergence and early growth.

Dry bean seed (14 percent moisture or below) is the most easily damaged. Bagged seed should not be dropped or thrown onto hard surfaces.

Sunscald: Intense sunlight, especially following cloudy and humid weather, can produce small water-soaked spots on the exposed sides of leaves, stems, branches and pods. These spots turn reddish or brown and may grow together into large necrotic lesions. Air pollutants and tropical spider mites can produce similar symptoms.

Heat Injury: High daytime temperatures may cause lesions that form a constriction around the stem at the soil line, especially on light-colored sandy soils. Temperatures above 35.5°C cause **blossom drop** if they occur during flowering.

Chemical disease control recommendations

Seed Treatment With a Fungicide

Effectiveness

- **Seed rots (pre-emergence damping off)**: Very good.
- **Seedling blights** (maize, sorghum, millet, peanuts): Fair.
- **Seedling root rots**: Poor to fair.
- **Seed-borne fungal diseases**: Very good if the spores are carried on or close to the seedcoat surface as with loose smut and covered smut of sorghum. Poor if the disease is deeper inside the seed as with bean anthracnose.
- **Seed-borne bacterial diseases**: Poor.
- **Seed-borne viruses**: Ineffective.

Seed treatments are very economical and are recommended for all the reference crops, especially for peanuts and the other pulses. They are most beneficial under wet conditions, particularly in cool weather where germination is slowed.

How to Treat Seed

Seed from commercial or government sources may come pretreated with a fungicide or fungicide/insecticide combination. Check the label and look for a red, purple or green dust on the seed. Farmers can treat seed by mixing it with the correct amount of fungicide dust. Large quantities of seed can easily be treated using an oil drum set up to rotate on its longitudinal axis in an offset manner, but bean and peanut seed must be treated gently. Some treatments are applied as slurries (liquids); farmers should always follow label instructions.

A mixing drum for applying insecticide and/or fungicides to seeds prior to planting.

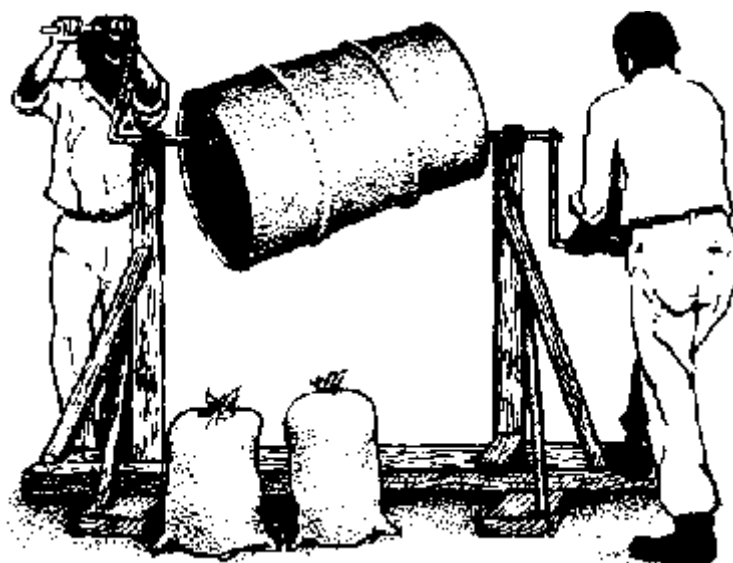

Precautions: With the exception of mercury compounds like Ceresan, Semesan, and Agallol, seed treatment fungicides are relatively non-toxic, although some can cause skin and eye irritation. Avoid using mercury compounds. NEVER use any treated seed for human or animal consumption. Combination fungicide/ insecticide treatments containing Dieldrin or other Class 1 and 2 compounds should be handled with rubber gloves.

Table 10 Recommendations for Seed Treatment

The following recommendations are based on current information from North Carolina State University and CIAT

CROP	TREATMENT	Grams/kg	Oz/100 lbs. of seed
Maize	Arasan (thiram) 50% dust	1.5	2.5
&	Captan (Orthocide) 75% dust	0.75	1.25
Sorghum	Dichlone (Phygon) 50% dust	0.6	1.0
Peanuts	Arasan (thiram) 50% dust	2.0-2.5	3.0-4.0
	Captan + Maneb (30-30 dust)	2.0-3.0	3.0-5.0
	Botran + Captan (30-30 dust)	2.0-3.0	3.0-5.0
	Difolatan + Captan (30-30 dust)	2.0-3.0	3.0-5.0
	Vitavax (carboxin) 75% W	2.0-3.0	3.0-5.0
	Vitavax + Arasan or Captan	1.25-2.0	2.0-3.0
Beans	Arasan, Captan, Zined, Busan or Vitavax	.0-3.0	-

NOTE: Increase dosage on sorghum by about 25-50%, since it has more surface area per kg.

NOTE: The combinations are recommended where Aspergillus seedling blight is prevalent. Vitavax is a systemic fungicide. Inoculated peanut seed should be treated immediately before planting.

NOTE: Seed coat infections of anthracnose have been effectively controlled with Arasan 75% dust applied at 5g/kg of seed.

Recommendations for Soil Fungicides

Vitavax (carboxin) and PCNB (Terrachlor) are sometimes applied to the seed furrow at planting or to the row soil during crop growth to control soil-borne diseases like Southern stem rot and root rot. They are

rarely necessary or economical for maize, sorghum, and millet and are usually not justified on peanuts and beans unless potential yields are high and disease problems are serious.

Peanuts

Southern stem rot control: Apply PCNB preplant at active ingredient 11 kg/ha in a band 20-30 cm wide centered over the row or at early pegging stage in a band 30-40 cm wide. Pre-plant applications should be incorporated 5.0-7.5 cm deep. When applying PCNB at early pegging, direct the spray so that it reaches the soil at the base of the plants. If granules are used, don't apply them when the plants are wet. Drag bags over the plants to settle the granules to the soil. **Vitavax** can be applied in the same manner at early pegging using 1.1-2.25 kg/ha active ingredient (Recommendations from North Carolina State University and Clemson University.)

Beans

Root and stem rot caused by *Sclerotium rolfsii*: Application of PCNB at 3.4-4.4 kg/ha of active ingredient to the seed and surrounding soil at planting has proven effective in Brazil (CIAT data).

Root rot caused by *Rhizoctonia solani*: North Carolina State University recommends PCNB at 100-150 grams active ingredient per 1000 meters of row length applied at planting time to the seed and surrounding furrow soil.

Recommendations for Foliar Fungicides

Protectant versus Eradicant Fungicides

Most fungicides like Maneb, Zineb, Difolatan, and Manzate act as protectants by remaining on the leaf surface to prevent fungal spores from germinating and penetrating the plant. They have little or no eradicant ability to stop the progress of an existing infection. However, a few fungicides like Benlate (benomyl) and Thiabendazole (Mertect) are actually absorbed into the leaf tissue and translocated outwards toward the margins. These systemic fungicides act as eradicants as well as protectants and also have other advantages:

- They are not vulnerable to being washed off the foliage by rainfall or sprinkler irrigation.
- Since they are translocated within the leaf, uniform foliage coverage is not as important as with the non-systemic protectant fungicides.

The main disadvantage of the systemic fungicides is that they are effective against a narrower range of fungal diseases than most of the protectant fungicides, so more care must be taken to match the product to the disease. Vitavax (carboxin) and Plantvax (oxycarboxin) are two other systemic fungicides mainly used for seed treatments and soil application.

Guidelines for Applying Foliar Fungicides

Type of Crop: Foliar fungicides are seldom economical for maize, sorghum, and millet. They will give the best benefit/cost ratio when used on well-managed peanuts and beans under conditions where fungal leaf diseases are a limiting factor.

When to Apply: Ideally, applications should start slightly before the onset of infection or at least before the disease signs have become very evident. This is especially important when non-systemic protectant fungicides are used. In most growing areas, the major fungal leaf diseases are somewhat predictable as to their date of first appearance. Fungicides are too expensive to be used on a routine basis from the time the plants emerge. Besides, most fungal diseases do not infect plants until around flowering time or after.

Frequency of Application: This depends on disease severity, rainfall, and type of fungicide. The non-systemic protectant fungicides can be washed off the foliage by rainfall (or sprinkler irrigation), but the

systemics remain safely within the plant once they have been absorbed. Under frequent rainfall, the protectants may have to be applied as often as every four to seven days. Under drier conditions, intervals of 10-14 days are normal. Systemics are usually applied once every 12-14 days regardless of rainfall frequency. Disease severity also affects application frequency but is usually closely related to rainfall and humidity (as well as varietal resistance).

Uniform and thorough coverage of crop foliage is very important when applying fungicides. This is especially true for the protectant products which are effective only on those portions of the leaf surface they actually cover. An attempt should be made to cover both sides of the leaves when using protectants. Stickers and spreaders are recommended for nearly all fungicide sprays to enhance coverage and adhesion.

Duter is one exception, since these additives increase the likelihood of crop injury from that particular product. Some fungicides already contain stickers and spreaders, so be sure to read the label. Amount of water needed for adequate foliage coverage: This varies with plant size, crop density, and type of sprayer. When using backpack sprayers on full-size plants, at least 700 l/ha of water is needed.

Dosage Recommendations

Label instructions and extension service recommendations are the specific guidelines to follow. The following recommendations are meant to serve as general guidelines.

Peanut Cercospora Leafspot: Benlate and Duter have generally proved the most effective, although most other products, such as Dithane M-45, Antracol, Bravo (Daconil), Difolatan, copper-sulfur dusts, and copper-base sprays, also give satisfactory control. The following recommendations come from North Carolina State University (U.S.A.) and Australia.

Duter 47% WP, 425 g actual formulation per hectare. Do not use a sticker or a spreader.

Benlate 50% WP, 425 g actual formulation per hectare plus sticker-spreader.

Control is enhanced by combining 285 g Benlate plus 1.7 kg Dithane M-45 or Manzate 200 plus 2.3 non-phytotoxic crop oil per hectare. The oil improves penetration.

Daconil (Bravo), 875-1200 g active ingredient per hectare.

Copper-base products like copper oxychloride, copper hydroxide, and basic copper sulfate can be used at 1.85 kg active ingredient per hectare.

Antracol 70% WP can be used at 1.7 kg/ha.

Copper-sulfur dust: Follow manufacturer's recommendation.

Note: Do not feed treated hay to lives unless only copper or copper-sulfur products are used. Duter helps retard spider mite buildup. Plant injury may result if a sticker-spreader is used with Duter.

Bean Leaf Diseases: Potential bean yields must be high to warrant the use of foliar fungicides. Systemics should be considered where rainfall is high if they are effective against the disease involved.

Anthracnose: Literature from CIAT recommends Maneb 80% W or Zineb 75% W at 3.5 g/l of water, Benlate at 0.55 g/l, Difolatan 80 W at 3.5 kg/ha, and Duter 47 W at 1.2 g/l.

Rust: Suggestions from CIAT are for Dithane M-45 or Mancozeb at 3-4 kg/ha; Manzate D 80 W or Maneb 80 W (Dithane M-22) at 4 kg/ 1000 l/ha; sulfur dust at 25-30 kg/ha. Plantvax (oxycarboxin), a systemic, has been found effective when sprayed at a rate of 1.8-2.5 kg/ha of the 75% WP at 20 days and 40 days after planting or every two weeks until the end of flowering.

White mold (Sclerotinia): North Carolina State University recommends Benlate 50 W at 1.72.25 kg/930 l/ha on Botran (dichloran) 75 W at 4.5 kg/930l/ha.

Web blight: Recommendations from CIAT are for Benlate 50 W at 0.5 kg/ha (0.5 g/l at 1000 l/ ha) or Brestan 60 at 0.8 kg/ha or Maneb (Dithane M-22) at 0.5 g/liter. (Note: The Maneb dosage seems unusually low.)

Angular leafspot: Literature from CIAT suggests Benlate 50 W at 0.5 g/l, Zineb, Mancozeb, Ferbam-sulfur-adherent (no dosages given).

Bacterial blights: Use copper-base sprays and follow label directions.

Nematodes

Nematodes are tiny, colorless, thread-like roundworms 0.2-0.4 mm long. There are many kinds of plant-feeding nematodes. Most live in the soil and feed on or within plant roots using needle-like mouthparts for piercing and sucking. They dissolve the roots' cell contents by injecting an enzyme which produces various reactions depending on the type of nematode. The root-knot nematode causes portions of the roots to swell into galls or knots, while root lesion nematodes produce dark-colored lesions on the roots. Sting nematodes and stubby-root nematodes prune the root system and make it appear stubby. Root growth is often stopped and becomes very susceptible to attack from bacteria and fungi.

Nematodes are most prevalent and active where soil temperatures are warm. They seem to prefer sandier soils or those portions of the soil where fertility or moisture are low. However, clayey soils can have serious nematode problems, too.

Since they are so tiny, nematodes seldom move more than a few inches a year. Unfortunately, they are spread easily by soil carried on tools and equipment or by water runoff from a field.

Maize, sorghum and millet are fairly resistant to most kinds of nematodes, and yield losses seldom exceed 10-15 percent. The pulses are most vulnerable to root lesion and sting nematodes which feed on roots, pegs, and pods. Beans and cowpeas are attacked by root knot, root lesion, and sting nematodes plus several other types. In Kenya, heavy infestations of root knot nematodes have reduced bean yields by up to 60 percent in some cases.

Diagnosing Nematode Damage

Above-ground symptoms are seldom distinctive enough to make a conclusive diagnosis without examining the root system, but the following are possible indications of nematode damage:

- Stunting, yellowing, lack of plant vigor. However, these can be caused by many other problems--low fertility, diseases, excessive soil acidity or moisture, for example.
- Wilting, even when moisture seems to be adequate and heat is not excessive. This can also be caused by soil insects, borers, and diseases.
- Damage almost always occurs in scattered patches in the field and is rarely uniform. This is an important characteristic of nematode problems.

Root symptoms, as described below, may be observed if the roots are carefully dug up and examined:

- Galls or knots are a sure sign of root knot nematode damage. These should not be confused with the Rhizobia bacteria nodules attached to the roots of legumes. The galls or knots caused by root knot nematodes are actually swollen portions of root.
- Other types of nematodes cause tiny, dark-colored lesions, stubby roots or loss of feeder roots. This damage should not be confused with that caused by rootworms, white grubs or other insects.

Nematodes

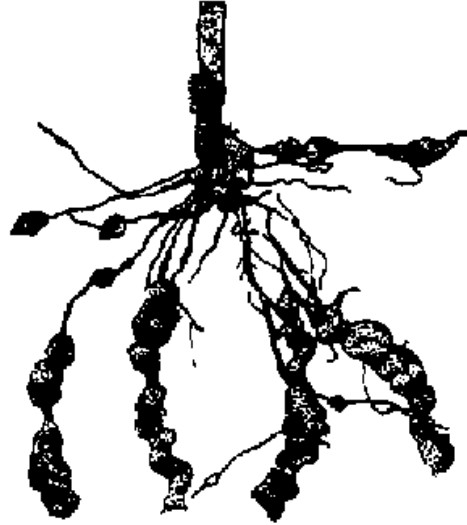

Root knot nematode galls on bean roots. Note how they differ from nodules by actually being part of the root.

Laboratory diagnosis is usually needed to confirm nematode damage, although root knot nematode injury is often readily apparent. Plant pathology labs in most countries can test soil and root samples for nematodes. It will be necessary to take 10 random sub-samples within the field right next to the plants using a shovel for testing. Sample the soil by digging down about 20-25 cm and discarding the soil from the top 5 cm and from the sides of the shovel. The remaining soil should be placed in a pail, making sure some roots are included. The sub-samples should be mixed together and a half-liter of the soil placed in a plastic bag. The sample should be protected from sunlight or excessive heat, preferably by refrigerating it until mailing time. A lab diagnosis is also valuable for planning a suitable crop rotation program to reduce nematode numbers, since different types vary in their crop preferences.

Nematode Control

Complete eradication is impossible, but chemical and non-chemical controls can reduce populations to tolerable levels.

Non-Chemical Controls

Crop rotation: This is sometimes difficult or impractical, since most types of nematodes have many crop hosts as shown below:

- Root crop nematodes (*Meloidogyne* spp.): Beans, cowpeas, cucumber, squash, watermelon, cantaloupes, tomatoes, tobacco, okra, cotton, carrots, lettuce, peas and strawberries are very susceptible, but peanuts can be attacked also. Grass family crops tend to be less vulnerable. Cotton and peanuts can also be included in the same rotation, since they do not share the same root knot species. However, planting cotton immediately prior to peanuts will cause a buildup of peanut soil diseases.
- Root lesion nematodes (*Pratylenchus* spp.): Beans, cowpeas, peanuts, soybeans, tobacco, okra, pepper, potatoes, sweet potatoes, tomatoes, sugar cane and strawberries are among the most susceptible. Maize is less so, and sorghum and millet have better resistance.

- Sting nematodes (Bolonolaimus spp.): Beans, cowpeas, cotton, soybeans, maize, millet, sorghum, sweet potatoes, tomatoes, squash and pasture grasses are among the hosts. Tobacco and watermelons are resistant.

Some types of tropical legume tree such as Prosopis spp. harbor nematodes. Host country extension services sometimes have a nematode specialist who should be consulted concerning crop rotations and other controls.

Resistant varieties: Varieties differ somewhat in their resistance to nematodes.

Exposure: Plowing up roots of susceptible crops right after harvest will expose them to sunlight and drying, which will kill many of the nematodes.

Flooding: One month of flooding followed by a month of drying and a further month of flooding will greatly reduce nematode problems, but is not often feasible.

Antagonistic plants: Many garden books recommend inter-planting marigolds among susceptible crops to control nematodes. Unfortunately, research has shown that marigold species vary in their effectiveness, which is limited mainly to one type of nematode, the root lesion nematode. Furthermore, marigolds do not kill nematodes, but starve them out. This means that interplanting is not effective, since the nematodes will still have a food source. Marigolds would have to be planted exclusively and then followed by a crop susceptible to root lesion nematodes in order to provide some control.

Two legume green manure or cover crops, Crotalaria spectabilis (showy crotalaria or rattlebox) and Indigo fera hirsuta (hairy indigo) can reduce populations of most type of nematodes.

Soil: Good soil fertility and high soil organic matter levels help somewhat.

Chemical Controls

Soil fumigants: Some of these, like methyl bromide, Vapam, Basamid and EDB are often used on vegetables or transplant beds, but are either too expensive or require specialized application equipment. Some are very dangerous.

Non-fumigant nemades: These include Mocap (ethoprop), Furadan and Dasanit, and can be applied as granules to the crop row and are effective against some insects. Under small farmer conditions, their use on maize and other cereals for nematodes only would be uneconomical except in cases of heavy infestations and high potential yields. There may be some cases where their use is justified on the pulses, especially peanuts. Product use guidelines for some of the more common nemades:

NEMAGON (DBCP, Frumazone): Comes as a liquid or granules but has been virtually banned in the U.S. as a possible carcinogen. Prolonged exposure over the years has caused testicular atrophy in males. Stay away from this one.

FURADAN (Carbofuran): See description under Section B. Has a very low dermal, but very high oral toxicity.

Nematode application guidelines are:

Peanuts: Apply a band 30-35 cm wide over the row before planting; use 2.2-4.5 kg of active ingredient per hectare. Needs to be worked into the soil 5.5-15 cm deep.

Maize: Apply in a band 18-36 cm wide over the row before planting and work into the top 5-10 cm of soil. Use 1.7-2.25 kg of active ingredient per hectare.

MOCAP (Ethroprop, Prophos): Kills nematodes and soil insects but is very toxic both orally and dermally. Applied like Duradan at the rate of 1.7-2.25 kg active ingredient per hectare. Not recommended for most small farmers. Non-systemic.

TEMIK (Aldicarb): A systemic insecticide/nemad with extremely high oral and dermal toxicity. Avoid it.

DASANIT (Terracur, fensulfothion): A non-systemic product for soil insects and nematodes. Very high oral and dermal toxicity. Avoid using.

NEMACUR (Phenamiphos, Fenamiphos): A systemic product for nematodes, soil insects, and above-ground sucking insects. Class 2 toxicity. Applied to peanuts like Furadan at 1.7-2.85 hectare. Handle with care. Use Furadan instead if possible due to its much lower dermal toxicity.

Bird and rodent control

Birds

Seed-Eating Birds

In parts of Africa and in other areas, birds like the bush fowl dig up and eat freshly-planted seeds, They often uproot young seedlings of maize and other cereals during the first several weeks of growth as well.

Controls: Scarecrows are relatively ineffective, although noise-making devices may offer some control. It is often necessary to frighten away the birds from planted fields during their usual early morning and late afternoon feeding times for the first two or three weeks after planting. Farmers sometimes soak their seeds in highly toxic insecticides like Endrin and Dieldrin and plant them or use them as scattered bait. This is not only dangerous, but can lead to indiscriminate killing of wildlife. Some safer repellents are available such as Mesural 50 percent dust, which is mixed with maize before planting at the rate of 9-10 g/kg to repel blackbirds. Mesural may injure maize seed under cool, wet conditions. Dusting seeds with Captan fungicide or soaking them in turpentine may provide a fair repellent effect.

Perhaps the most effective control method is continuous string flagging which uses cloth or plastic streamers 5-6 cm wide and 50-60 cm long. The streamers are attached at 1.5 m intervals to strong twine which is strung along heavy stakes at least 1.2 m tall spaced about 15 m apart.

Quelea Birds

The Quelea bird (Black-Faced Dioch) is a sparrow-sized weaver that may be the world's most destructive grain-eating bird. It is confined to the Sahel and savanna regions of Africa in a band running from Senegal to Mauritania to Ethiopia and Somalia and then south through East and South Africa and across into Angola.

The birds congregate in vast nomadic colonies that feed on the seeds of both natural grasses and crops like millet, sorghum, rice, and wheat, mainly in the unripe stage. (Maize is less affected.) Queleas begin breeding a few weeks after the rainy season begins and build their nests in thorn trees or swamp grasses. Studies in Senegal have shown that even small trees can hold up to 500 nests and taller ones up to 5000-6000. Each pair of Queleas can produce two young.

Controls: In areas prone to attack, the villagers build high platforms in the fields and maintain noise-making vigils, sometimes for many weeks, while the grain is ripening. Governments frequently undertake mass Quelea extermination campaigns which center around the destruction of nesting and roosting sites with explosives, flamethrowers, etc. South African authorities killed 400 million with aerial sprays in one four-year campaign. However, the birds usually return in undiminished numbers within a year or two, since they are highly nomadic and have extensive breeding grounds estimated to cover two million square miles. At the present time, bird-resistant crop varieties are not very successful against the Quelea, and the same seems to be true of repellents like Avitrol and Morkit.

Other Grain-Eating Birds

Blackbirds (grackles, starlings, etc.), sparrows, cockatoos, parrots, galahs and pigeons also feed on grain crops, though usually in less awesome numbers than Queleas. Bird-resistant varieties of sorghum (see Chapter 3) are fairly effective at repelling them while the grain is ripening, but lose this ability when maturity nears. Repellants like Avitol (aminopyridine) are often used successfully in the U.S. The usual result of using repellents in one field, however, is that the birds move on to attack other fields that are unprotected.

Rodents

The cane rat (*Thronomya sp.*) can cause considerable losses of cereal crops during the latter stages of growth, especially if lodging has been heavy due to high winds or diseases.

Controls:

- Rodents can be discouraged from entering fields by maintaining a 2.0-3.0 m wide cleared swath around the field borders from planting until harvest. Fences made from oil palm fronds or split bamboo are also effective, especially if traps or wire snares are set in the gaps.
- Good weed control in the field is helpful.
- Leaning or fallen plants should propped up and the dry lower leaves stripped off to help deter climbing.
- Many villages carry out organized killing campaigns. The best time for such campaigns is during the dry season when the rats congregate in the few remaining pockets of green vegetation.
- Repellants like Nocotox 20 may be partly effective.
- Rats should be prevented from gaining access to stored grains and other food that can cause a buildup in populations during the dry season. (See Chapter 7.)
- Poison baits can be used.

NOTE: Killing rats in the field with poisons, traps, and other methods is usually not a very effective long-term solution. The best approach is to prevent a rat population buildup; this requires area-wide coordination. The PC/ICE Small Farm Grain Storage manual contains a very useful section on rat control.

7. Harvesting, drying, and storage

For the farmer, the challenges of agriculture do not end when a successful crop reaches maturity in the field. Losses between maturity and consumption or sale are frequently serious, especially for the small farmer, and are also a major contributing factor to the world food problem. This chapter focuses on specific practices that will keep these losses at a minimum.

From maturity to harvest

Maize, Sorghum And Millet

When these cereal crops reach physiologic maturity, the grain is still too wet and soft for damage-free threshing (separation from the stalk or ear) or for mold-free storage. Most small farmers let the crop dry naturally in the field for several weeks prior to harvest, unless immediate land preparation is needed for the next crop. During this "dry-down" period, the crop is vulnerable to losses caused by several factors:

- Rodents: Losses are especially high where lodging or stalk breakage is severe.
- Lodging and stalk breakage: These may occur during the dry-down period and are encouraged by overly-high plant densities, low soil potassium levels, high winds, and stalk rots. They promote rodent damage and grain rots, especially when the ears or seedheads touch the soil.
- Grain rots: Wet weather during dry-down may provoke fungal grain rots (head molds, ear rots) or accelerate those that may have begun during grain filling. Some small farmers bend the maize ears downward near maturity to prevent water from entering through the tips.
- Weevils and other storage insects: Some storage insects like the rice weevil (*Sitophilus oryzae*) and the Angoumois grain moth (*Sitotroga* sp.) can fly to the fields and infest crops from the soft dough stage onward. Maize varieties with long, tight husks have good resistance, but high-yielding varieties tend to be inadequate in this respect.
- Birds: Most species prefer younger, softer grain but can still cause problems after maturity. Bird-resistant sorghum varieties lose their repellent ability by the time maturity is reached.
- Theft: Farmers should be encouraged to harvest their crops as soon after maturity as is practical to prevent losses from theft.

Beans and Cowpeas

Losses between maturity and harvest of beans and cowpeas are caused by:

- Pod shattering: Spillage of seeds from drying pods that split can be a problem, but losses are not usually serious unless harvest is delayed.
- Bruchid weevils: (See section on storage.) These are not only serious storage pests of pulse crops but also can fly to the fields to infest beans and cowpeas by laying eggs in cracks or cuts in the pods.
- Seed deterioration: This can be a serious problem in beans and cowpeas and can occur soon after maturity if rainfall continues. Studies by IITA have found that cowpea seed quality and germination decline rapidly when harvest is delayed. In tests under wet conditions, seed germination fell to 50 percent or lower within three weeks after maturity, and pre-harvest fungicide sprays were of little benefit in preventing this.
- Delayed maturity: Literature from CIAT mentions that bean plants may put out new growth and flowers during maturation under high rainfall. The new foliage can interfere with the proper drying of the maturing pods and may lead to rotting.

Peanuts

Peanuts pose a special problem since the nuts do not mature simultaneously. Those that ripen first may become detached from the pegs before the rest mature. The timing of the harvest is critical and will be covered in the next section.

Harvesting and threshing

Nearly all small farmers in the developing countries harvest their cereal crops and beans by hand and thresh them later. In the case of peanuts, harvesting involves lifting the plants and attached pods from the ground, then allowing them to cure (dry) in the field for a period of from several days to four to six weeks before threshing.

Threshing consists of separating the seeds from the seedheads, cobs or pods by beating, trampling or other means. With peanuts, threshing separates the pods from the pegs that hold them to the plant and does not include actual shelling. (With maize, the term "shelling" is usually used in place of "threshing".)

With cereal crops and beans, the small farmer has several options as to when to thresh the crop. If the matured crop has stood in the field for some time during dry weather, the seeds may be low enough in moisture content to be threshed without damage right after harvest. However, the farmer may still prefer to delay threshing for two reasons:

- The grain may still be too high in moisture content to escape spoilage if stored as loose seed. Grain stored in unthreshed form on the cob, on the seedhead or in the pod can be safely stored at a much higher moisture content since there is much more air space for ventilation and further drying.
- Maize stored as unhusked ears and pulses stored in their pods are more resistant to storage insects.

Winnowing follows threshing and consists of separating chaff and other light trash from the grain using wind, fan-driven air or screens. Winnowing may need to be repeated several times before consumption or marketing and is usually supplemented by manual removal of stones, clods, and other heavy trash.

Guidelines for Harvesting and Shelling Maize

Determining Maturity

In the 0-1000 m zone in the tropics, most maize varieties reach physiologic maturity within 90-130 days after seeding emergence or 50-58 days after 75 percent of the plants have produced silks. As maturity nears, the lower leaves begin to yellow and die off. In healthy, well-nourished plants, this should not occur until the ears are nearly mature. Ideally, most of the leaves should still be green when the husks begin to turn brown. Unfortunately, such high-yielding plants are not often seen in small farmer fields because of stress factors like low fertility, insects, diseases, and inadequate weeding. More typically, most of the leaves are dead by the time the plant matures.

The "black layer" method: When a maize kernel reaches physiologic maturity (maximum dry weight), the outside layer of cells at its base where it connects with the cob will die and turn black, thus preventing any further cob-to-kernel nutrient transfer. This "black layer" provides an indication of maturity. The layer can be seen by detaching kernels from the cob and examining their bases. Newly-matured kernels may have to be slit lengthwise with a pocketknife to expose the black layer. However, with older kernels, the layer can be readily seen by scraping the base with the fingernail.

Keep in mind that physiologic maturity is not reached until all the kernel's milky starch has solidified. This process begins at the tip of the kernel and moves downward toward the base. The kernels at the ear tip are the first to mature, followed by those in the middle and finally the ones at the lower end (the difference is no more than a few days).

With healthy plants, kernel moisture at physiologic maturity will vary from about 28-36 percent. This is usually too high for damage-free threshing or for mold-free storage except in the form of husked ears placed in very narrow cribs. The black layer may form much earlier in the maize plant's growth cycle if growing conditions are adverse. Such kernels will be small and shrunken and have much higher moisture contents when the black layer forms.

The dry-down rate of maize: When maize plants are left standing in the field after maturity, the kernels lose about 0.25-0.5 percent moisture per day, but this can range from 0.1 - 1.0 percent depending on weather conditions and whether the ears are pointing downwards to prevent water entry.

Methods of Harvesting Maize:

- By Hand: The ears are removed by hand from the plants with or without husking. Husked ears require a smaller storage area and are more resistant to insects, but may rot more easily if stored at a high moisture content.

- Mechanical: Tractor-drawn pickers and picker-shellers can handle one to two rows at once, but self-propelled combines are available which can harvest up to six to eight rows. By changing the front attachment (the "head"), combines can also harvest other cereal crops (if not overly tall) and bush beans, but cannot be used on peanuts. Well-adjusted pickers and combines should have losses of less than 2 percent and 4 percent respectively unless lodging is severe.

When to Begin Harvesting

Harvest should begin as soon as is practical after maturity, but this depends on the farmer's harvest method and storage and drying facilities.

Hand harvesting: Since husked ears can be safely stored in narrow cribs (see storage section) at up to 30-32 percent kernel moisture, harvest can be started at or soon after maturity if desired. Most small farmers prefer to let the maize dry down further in the field first.

Mechanical harvesting

- Pickers If narrow cribs (see storage section) are used for storage, mechanical picking can be started once kernel moisture is down to 30-32 percent.
- Picker-shellers and combines: In this case, adequate drying facilities and kernel damage from shelling are the main concerns. In the tropics, shelled maize above 14 percent moisture will not store more than a week to a few months without spoilage. Rapid drying is essential and usually requires forced air and heated dryers when large volumes are involved. Kernel damage from mechanical shelling may become serious above 28-30 percent or below 15-18 percent moisture.

Methods of Shelling Maize

If done too roughly or at too high a moisture content, shelling can cause kernel damage such as tip loss, cracking, stress cracks, and pulverization. Studies have shown that damaged kernels spoil two to five times more rapidly during storage than undamaged ones. Hily sine varieties and other floury types are more susceptible to damage. Shelling methods and guidelines for small farmers include these:

Traditional methods

- By hand: This method is very tedious and labor-intensive, but causes little damage to the kernels. It is more thorough than other methods and also allows for separation of damaged and insect-infested grain. This method is best suited to small amounts.
- Beating: Dry ears are placed in bags and beaten with sticks. This is quicker but less thorough than hand shelling and may cause damage.

Wooden, hand-held maize sheller

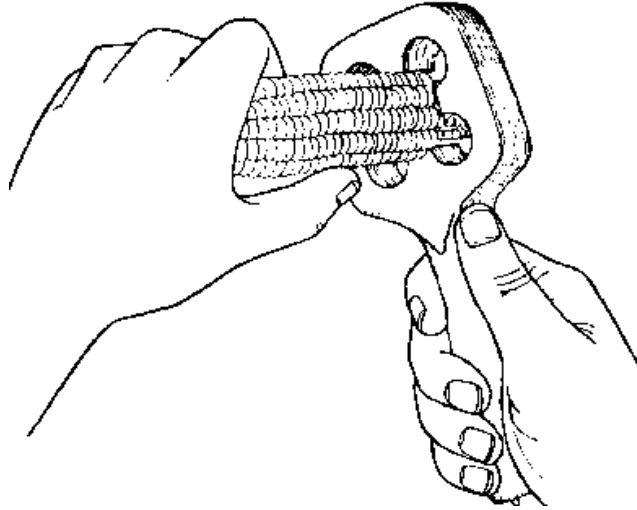

Improved methods

- Wooden hand-held maize sheller: The model shown in the drawing was developed by the Tropical Products Institute and has an output of roughly 80 kg/hour. (Plans are available from ICE.) Other types of hand-held shellers are available commercially. Cobs must be husked first.
- Hand-cranked or pedal-operated shellers: Small, hand cranked models have outputs of about 50-130 kg/hour. The Ransomes Cobmaster twin-feed pedal-operated sheller has an hourly output of 750-900 kg. For details write Ransomes Ltd., Ipswich IP3 90G, England. Maize at too high or too low a moisture content is likely to be damaged, but this can be checked visually. Ears must be husked first.
- Motor-driven shellers have outputs of about 1000-5000 kg/hour. The comments above also apply to this type.

Winnowing Methods

Reliance on wind is the traditional method, but hand-cranked or pedal-driven fans can be constructed easily. The larger models of the hand-cranked or pedal-operated shellers usually are equipped with blowers.

Guidelines for Harvesting and Threshing Sorghum And Millet

Determining Maturity

When grown under favorable conditions and good management, grain sorghum reaches physiologic maturity while the stalks and most of the leaves are still green. Like maize, sorghum kernels also develop a "black layer" at their base when physiologic maturity is reached. The layer can be checked by pinching off some kernels from the bracts that hold them to the head and examining their bases. If present, the black layer can be seen without splitting the kernel. Sorghum flowers and pollinates from the tip of the seedhead downward, a progression which takes from four to seven days. The kernels mature in the same direction, with those at the bottom lagging about a week behind those at the top. Kernel moisture content is about 30 percent at physiologic maturity.

Methods to Harvest Sorghum

- By Hand: The seedheads are cut off using a knife or sickle.
- Mechanical: Tractor driven or self-propelled combine harvesters can harvest and thresh short (dwarf) and medium varieties.

When to Harvest Sorghum

In most sorghum-growing regions in developing countries, maturity often coincides with the start of the dry season, and the crop may be left standing in the field to dry for a number of weeks before harvest. Crop losses during this period can be heavy. If dry conditions prevail, the crop can be harvested at or shortly after maturity and stored on the head with little danger of spoilage. Sorghum can be harvested and threshed with a combine once kernel moisture reaches 25 percent. However, loose grain that is this "wet" must be dried down to around 14 percent within a few days to avoid spoilage. If large amounts of grain are involved, some form of forced air or heated drying would probably be needed.

Methods of Threshing Sorghum

- **Traditional methods:** These include pounding, beating, and animal trampling and are very tedious except for small quantities. Kernel damage is possible unless care is taken.
- **Mechanical methods:** Tractor- or motor-driven stationary threshers come in many models with outputs of 600-3000 kg/ hour. All but the simplest models will also clean the threshed grain by the use of shaking screens and/or blower fans.

Plans for a four-person pedal-powered grain thresher/mill for sorghum, millet, and wheat designed by VITA can be obtained from ICE. As of 1979, however, this thresher/mill had not been adequately field tested and is not suited to local village construction.

NOTE: Millet is harvested and threshed much like sorghum.

Guidelines for Harvesting and Threshing Peanuts

Peanuts reach maturity when the veins on the inside of the pods turn dark. However, since the plants produce flowers over a period of from 30-45 days, the nuts do not mature simultaneously. Unfortunately, harvesting cannot be delayed until all the nuts have ripened, because heavy losses may occur for two reasons:

- By the time the last pods ripen, many of those which matured earlier will have become detached from the plants due to peg rotting. This pod "shedding" can be especially serious when Cercospora leaf spot causes premature leaf loss or when lifting occurs in dry, hard soils.
- In Spanish-Valencia varieties, the early-maturing kernels may sprout if kept too long in the ground. The Virginia types have a lengthy seed dormancy period which prevents this.

Likewise, if harvesting occurs too early, an undesirably high proportion of the kernels will be immature, shrunken, low in weight, and inferior in flavor. The choice of harvesting date can easily make a 400-500 kg/ha difference on a high yielding crop.

How to determine "peak maturity": The farmer should aim for a harvest date that will recover the largest number of mature kernels before excessive pod shedding or sprouting has occurred. This is often referred to as "peak maturity", and there are no easy rules for determining it. The pattern of flowering, pod setting, and kernel maturation varies from year to year due to differences in weather and leaf spot incidence. The first 40-60 flowers to bloom are generally the ones that end up as mature kernels at peak maturity. Flowering starts about 30-45 days after plant emergence in warm areas and begins very slowly. In fact, most of these 40-60 flowers usually bloom near the end of the flowering period, although there may be several "bursts" of flowering.

Peak maturity cannot be determined by looking at the aboveground portion of the plants. The best method is to carefully dig up a few plants every several days beginning near the end of the growing period and examine the pods. With experience, the farmer can learn to estimate quite accurately how many young pods will ripen before the matured pods begin to shed or sprout.

Minimizing crop losses: Pod shedding can be reduced by keeping the plants green and healthy until maturity. This often requires controlling Cercospora leaf spot with fungicide sprays or dusts. This also increases yields by prolonging the growing season by as much as two to three weeks. Some farmers, however, may object to having leafy green foliage at harvest time, since it may slow down the rate of field curing when the harvested bushes are placed in stacks. In this case, farmers may purposely stop their fungicide applications late in the season to promote defoliations. This also has the effect of making maturity more uniform, although yields are reduced. Such a practice may be justified in some regions, especially where field curing weather is not always dry. On the other hand, farmers can use leafy plants for life feed after harvest.

(NOTE: In the U. S., extension service advise against feeding peanut hay to dairy or beef animals if it has received fungicide applications, except in the case of copper or copper-sulfur products.)

Peanut Harvesting

Whether traditional or modern methods are used, the harvesting process basically consists of four steps:

- The taproots are cut and the plants are pulled (lifted) from the ground with the attached pods.
- Under traditional methods, the plants are cured (dried) in the field for up to 4-6 weeks before threshing. With modern methods, the plants are cured in the field for 214 days, depending on whether artificial drying is available afterwards.
- The pods are threshed from the plants.
- The threshed pods are placed in bags for storage and possible further drying. In dry areas, the pods are often stored in outdoor piles.

Note that shelling the nuts from the pods is not normally a part of the harvesting process, since the kernels dry and store better in the pod. Shelling damage can be high unless kernel moisture is at or below 10 percent.

Methods of "Lifting" the Crop:

- By hand: The plants are pulled from the ground manually after loosening the soil with hand tools. It takes about 30 hours to pull and stack a hectare with this method.
- Animal-drawn methods: Special animal-drawn lifters are available and consist of a sharpened, horizontal blade that is run under the plants right below the nuts to cut the taproots, loosen the soil, and partially lift the plants. One hectare can be lifted and stacked in about 15 hours. A carefully operated weeding sweep (see Chapter 5) about 30-40 cm wide can be used, but the blade should be adjusted to slice rather than push through the soil to minimize pod losses. Some farmers use moldboard or lister plows on ridge-planted peanuts.
- Tractor-drawn methods: Tractors can be equipped with front mounted cutter bars and rear-mounted pullers that lift the plants. Two to four row setups are common, and some of the pullers will combine two or more rows into one windrow for curing. Peanut inverters are available that flip the bushes over to expose the nuts to the sun.

Some General Guidelines for Lifting

- Lifting the crop when the soil is too wet can weaken the pegs. It may cause excessive amounts of soil to adhere to the pods which can also slow down curing.
- Lifting losses can be high in very hard, dry soils.

- If cutter blades are used, they should be kept sharp and be set at a slight forward pitch to aid in lifting the plants and loosening the soil.

Methods for Curing and Threshing Peanuts

The method and length of curing prior to threshing varies considerably with weather conditions and the availability of equipment and artificial methods of drying. The most common methods are:

- The "stackpole" method: This is often used by mechanized and unmechanized farmers alike where curing weather can be wet and no means of artificial drying are available.

Poles are placed firmly in the ground, and two slats are nailed at right angles to each other about 50 cm above ground on each pole. After being allowed to wilt, the plants are stacked around the pole with the pods facing inward. The slats hold the bottom layer off the ground and also improve air circulation. The stack is built in a cone shape and the top covered with a few vines to help shed water. In some cases, the plants are kept in the stacks until kernel moisture is down to 8-10 percent. This may take up to four to six weeks in cool, wet weather.

If harvest takes place at the start of the dry season, the plants may be stacked right on the ground.

- Row or windrow curing: If artificial methods of drying are available or effective sun drying is possible, the plants may be cured in the field in rows or windrows for two to five days before threshing. Where post-threshing drying is less efficient, the curing period lasts about 7-14 days so the pods will be drier at threshing time.

Windrows can be made by hand or through careful operation of a side-delivery rake (tractor-drawn). The main advantage of windrows is that they save time when self-propelled modern threshers are used.

The plants can be placed upside down to expose the nuts to the sun. This will reduce damage in wet weather, but can lower quality under hot, sunny conditions.

Windrows that are overly compact and dense increase curing time and spoilage under wet conditions. After a heavy rain, it may be necessary to gently turn the windrow to prevent mold. This should be done before it dries out to minimize pod shedding. Avoid placing windrows over depressions in the field.

Methods of Threshing

- Traditional: Peanuts can be manually threshed by stripping the pods by hand or by striking the base of the plants (above the pods) against the edge of a barrel or wooden box.
- Improved: A hand-cranked thresher with an output of 200 kg/hr is being marketed in Senegal.

Stationary motor-driven threshers are available. Tractor-drawn or self-propelled threshers are used in modern farming and pick up the plants right from the windrows.

Threshing Guidelines

- Peanuts can be threshed any time after the plants are lifted as long as adequate natural or artificial drying methods are available (in the case of high-moisture nuts). Further drying will be needed after threshing for peanuts above 10 percent moisture intended for bulk storage and for peanuts above 16 percent intended for storage in loosely stacked bags under good ventilation. Peanut moisture content at lifting may be over 35 percent.
- Tips on mechanized threshing: Hull damage and splitting is lowest for peanuts threshed at 25-35 percent moisture. Letting the lifted plants dry down longer in the field reduces post-threshing drying

requirements but increases the weather risk. Unless the vines are dry enough to be easily torn apart, rough threshing action may be needed which will increase kernel damage.

Shelling Peanuts

Peanuts are not usually shelled until shortly before consumption or oil extraction. The shelling percentage is about 68 percent (1000 kg of unshelled peanuts yields about 680 kg of shelled kernels), and the process is most easily accomplished when kernel moisture is below 10 percent. Hand shelling is very tedious and the output is only about 10-20 kg/day. Various models of hand-cranked or pedal-operated shellers are commercially available with outputs about 15-90 kg/hour.

Plans developed by VITA for a belt-driven peanut huller made from scrap motor vehicle parts are available from ICE; some simple welding and cement work is needed. Power can be supplied by a water wheel, small motor or animal.

Guidelines for Harvesting and Threshing Beans And Cowpeas

Determining Maturity

The pods begin to turn yellow during the final stages of growth and become brown and rather brittle once maturity is reached. Determinate bush varieties and some indeterminate types have fairly even pod maturity, and the plants have usually lost most of their leaves by the time the pods have ripened. Most indeterminate vining types mature much less uniformly, and a good number of pods may ripen while most of the leaves are still green. Seed moisture content is around 30-40 percent at physiologic maturity.

When to Harvest

Indeterminate varieties with an uneven maturity are usually harvested in several pickings, while determinate bush types are harvested all at once when most of the pods are dry.

Method of Harvesting

The following methods apply to bush or semi-vine varieties with uniform maturity:

- **By hand:** The mature plants are pulled from the ground and placed in piles for drying. Pulling is best done in the early morning when the pods are moist to prevent shattering.
- **Mechanized:** Two basic methods are used. The plants are cut or "glided" out of the ground using a tractor with front-mounted horizontal blades with blunt cutting edges or rotating disks operated slightly below the soil surface. Several rows are combined into one windrow using a side-delivery rake which can be rear-mounted behind the cutters. The windrows are dried for 5-10 days before threshing with tractor-drawn or self-propelled threshers.

Direct harvesting is popular in the U. S. and Canada using grain combines with modifications.

Threshing Methods for Beans

Beans can be threshed manually by beating the plants or bagged pods with sticks once they are dry enough. Whatever the method used, bean seed can be easily injured if threshed too roughly or when too dry. Injured seed, when planted, will produce weak, stunted plants and other abnormalities (see Chapter 6 on bean diseases).

Winnowing beans: Refer to maize.

Drying and storage

Grain drying and storage are very broad subjects, and adequate coverage is far beyond the scope of this manual. Some of the more important principles and practices are outlined here. More detailed information can be found in the references listed in the bibliography.

Drying

Very moist grain will deteriorate and spoil during storage for two reasons:

- Since they are alive, the seeds consume oxygen and burn up some of the food stored in the endosperm for energy. This respiration process produces heat, but is too slow to be of concern in dry grain. However, respiration and heat production are rapidly accelerated by moisture, and the moisture and heat promote rapid mold growth and spoilage in wet grain.
- Storage insects like weevils become more active and multiply more quickly in warm, moist grain. They also produce heat and add more moisture which further increases mold growth.

NOTE: Some storage molds produce toxins called mycotoxins which are harmful to humans and lives. Aflatoxin is one example. All cereal and legume grains are susceptible if insufficiently dried or improperly stored, especially peanuts.

Fortunately, the farmers do not have to dry their grain down to zero percent moisture, since it can tolerate about 12-30 percent depending on the type, the form in which it is stored (ears or seedheads vs. loose grain), how it is stored (bags vs. bins, etc.), and the surrounding temperature and humidity. Most loose grain has about 12-15 percent moisture at marketing or prior to processing for consumption, and crop yields are usually calculated on about a 14 percent moisture basis. In fact, there are several disadvantages to drying grain below this range. Where grain is sold by weight overdrying will reduce the farmer's returns from a sale. It is also costly where artificial drying is used and can lead to cracking, discoloration, and poor germination.

Grain Moisture Guidelines for Safe Storage

Maize, Sorghum, Millet

- Loose: Threshed grain can be safely stored in silos or bins for up to a year at 25-30°C and 70 percent relative humidity if grain moisture is not above 13.0-13.5 percent for maize and sorghum, and 16 percent for millet. Bagged maize and sorghum can be stored at up to 15 percent moisture, since ventilation is much better.
- On the cob or seedhead: Husked maize ears can be safely placed in cribs for storage and further drying at kernel moisture contents up to 30 percent if all the ears are within 30 cm of open air. Sorghum and millet seedheads can also be safely stored and dried down from high moisture contents if kept in small stacks or hung from rafters.

Peanuts

For safe bulk storage of pods, kernel moisture content should not be above 10 percent. Pods can be safely placed in bags at kernel moisture contents up to 16 percent and will dry down adequately if loosely stacked, provided ventilation is sufficient. Otherwise, forced air will be needed.

Beans and Cowpeas

Threshed seed stored in bins or silos should not be above 13 percent moisture. Bagged seed can be safely stored at up to 15 percent moisture. Unthreshed pods can be kept at much higher moisture contents and will dry down well if ventilation is adequate.

How to Determine Grain Moisture

Grain moisture should always be calculated on a wet weight basis. In other words, 100 kg of 15 percent moisture maize contains 15 kg of water and 85 kg of dry matter. There are several ways of measuring grain moisture, some of which can be easily done on the farm with very little equipment:

Salt and bottle method: This quick and easy method is accurate to within 0.5% but will only indicate the grain is above or below 15% moisture, the maximum limit for storing maize and sorghum in bags.

- Thoroughly dry out a bottle of about 100 ml capacity and fill it three-quarters full with maize.
- Add 5-10 teaspoons of oven-dry table salt, seal the bottle with a dry lid or cork, and shake for several minutes. If the salt sticks to the inside of the bottle, the grain has over 15% moisture.

Oven method: A grain sample of known weight should be oven-dried for one or two hours at 130°C if ground or 72-96 hours at 100°C if in whole form. After reweighing, moisture content can be calculated as follows (cover the grain to avoid moisture reabsorption while it is cooling off):

% moisture of original sample = [Wet Weight - Dry Weight] / Wet Weight

Biting, pinching, rattling, feeling: Most farmers will use such methods for estimating grain moisture with varying success, depending on experience. They should not be relied upon where accuracy is important as in the case of grain stored in bulk (bins or silos).

How to estimate the final weight of grain after drying

Final grain weight after drying = [% dry matter before drying / % dry matter after drying] x original weight

Example: A farmer has 2000 kg of shelled maize at 20% moisture. How much will this amount of maize weigh after it has been dried down to 14% moisture?

Solution: To obtain the percent dry matter needed for the formula, subtract grain moisture content from 100 percent then use the formula.

Final grain weight after drying = 80% / 86% _ 2000 kg = 1860 kg of grain after drying to 14%

Some Important Grain Drying Principles

- Warm, dry, moving air encourages more rapid drying to a lower moisture content than cool, damp, still air. In fact, if the air becomes too damp, grain may actually begin to absorb moisture and become wetter.
- Air flow through the grain and air moisture content (relative humidity) have the biggest influence on drying. The lower the air's relative humidity the greater its ability to pick up moisture from the grain and carry it away.
- Warm air has a much higher moisture-holding capacity than cool air. This means that warm air is more effective at picking up moisture from wet grain than cool air when the relative humidity is low.
- Supplemental heat from either sunlight or fuel can be very effective at improving the drying ability of cool air if it is very damp (high relative humidity). For each 0.55°C rise in temperature, the relative humidity of the heated air is reduced by about 2 percent.
- The rate of drying slows down as grain moisture content falls, since the remaining moisture is given up less readily. Unless the air is very hot and dry, a point is eventually reached beyond which no further drying occurs. This is known as the equilibrium moisture content.

Methods of Drying

- Traditional sun-drying is the most common method used by small farmers and consists of spreading the grain out in a shallow layer on the ground for sun exposure. Depending on the weather, the thickness of the grain layer, and the amount of stirring, the results range from poor to good. The disadvantages are poor air circulation, contamination with dust and stones, and moisture absorption from the ground. The PC/ICE Small Farm Grain Storage Manual recommends general improvements for this system.

Enclosed solar drying reduces sun-drying time, requires no fuel, and can be used on other crops like cassava, copra, fruits, and vegetables. However, grain can be damaged or have its germination impaired by the extremely high temperature (65-80°C) that can build up under the plastic or glass sheet. Solar drying may not dry down grain rapidly enough when operated under very cloudy conditions (See bibliography for references containing plans for solar driers.)

- Fuel-Heated and/or Forced-Air Drying: For large quantities of grain, fuel-heated and/or forced-air drying is used. For the individual small farmer such drying may not be feasible. However, the procedure can be justified on a cooperative basis and can offer several advantages:

- Farmers can harvest their crops earlier at a higher moisture content to avoid losses caused by natural field drying. Earlier harvesting also permits earlier land preparation and planting of the next crop.
- The grain may end up at a lower, safer moisture content for storage and keep in better condition. Its market value may also be higher.

On the other hand, construction and fuel costs may outweigh these advantages, so a thorough analysis of the factors should be conducted before deciding to buy or build such driers.

Temperature Guidelines for Grain Drying

Excessively high drying temperatures can cause cracking, breaking, and discoloration of the kernels and also lower germination and protein quality. Peanuts may become bitter if dried at temperatures above 32-35°C, and overdrying increases splitting and skin slippage during shelling. Beans are also best dried at low temperatures.

The maximum safe drying temperature depends on the crop and its use:

Crop and Use	Maximum Safe Drying Temperature
Lives feed	75°C
Cereal grains for human food except rice	60°C
Milling for flour	60°C
Brewery uses	45°C
For planting seed	45°C
Rice for food	45°C
Beans for food	35°C
Peanuts	35°C

Storage

Storage losses of grain due to molds, insects, and rodents are estimated to be about 30 percent worldwide. Small farmers are especially vulnerable to such losses since their traditional storage methods are often inadequate to protect the crop. In many cases, farmers may be forced to sell much of their grain shortly after harvest at a low price rather than risk spoilage. A few months later, they may end up buying it back at a much higher price. By improving their storage facilities, farmers can ensure more food for their

families, more stable prices, and better quality seed for planting. Crop improvement programs should place a higher priority on providing ample safe storage for the expected production increases.

Principles of Safe Storage

- Grain must be adequately dried before being put into storage, although maize stored on the ear and other crops stored in the form of seedheads or pods can often be stored and dried at the same time using cribs or loose stacks.
- Undamaged, winnowed grain has a much longer storage life. Uncleaned grain reduces air movement, and the dirt and chaff hold moisture and encourage molds and insects. Damaged grain deteriorates two to five times more rapidly than undamaged grain.
- Grain should be kept as cool as possible and protected from fluctuations in outside temperatures that encourage condensation and moisture buildup inside the container.
- Grain should be protected from storage insects and rodents.
- Containers and buildings must be waterproof and free from groundwater.
- New grain should be stored separately from older grain.
- The old grain should be used first.
- The grain should be checked every two or three weeks for signs of heating and insects.

Traditional Storage Methods

If a farmer's production is small, it is often stored in the family dwelling. Maize ears and seedheads are commonly hung from rafters in the cooking area, the smoke acting as an insect deterrent. Clay pots, closely-woven baskets, and gourds are also frequently used. While such methods may work well with small amounts of grain, they are not well suited to large quantities.

Improved Storage

The PC/ICE Small Farm Grain Storage manual contains design details and guidelines for many types of improved storage. The major points are summarized briefly here.

Storing in sacks made of burlap, local grasses or cotton does not afford much protection against rodents, insects or moisture. However, sacks are easy to label and move around, and grain can be stored at about 2 percent higher moisture than is needed for airtight storage (i.e. about 15 percent versus 13 percent). For sack storage:

- The walls and the roof of the storage building should be waterproof.
- Sacks should be stacked on platforms (pallets) raised off the floor or on a plastic sheet. They should not lean directly against walls.
- The sacks should be stacked in a way that favors good ventilation.
- The building should be insect- and rodent-proof.
- The sacks should be sprayed or fumigated for insects, but only when grain will not be consumed directly by humans or animals (seed grains).

Silos and bins made from sheet metal, mud bricks, cement blocks or cement with metal staves can be built with capacities ranging from 500-4500 kg of dried, threshed grain. Some of them can be made

virtually airtight. However, whenever grain is stored in such large quantities, more care must be taken to ensure that it is well dried. Unless well insulated, the containers should be shaded to prevent large temperature variations which cause moisture migration, condensation, and spoilage of grain at the top and bottom.

Airtight storage in sealed gourds, underground pits, plastic bags, drums, and bins provides excellent insect control and also prevents the grain from reabsorbing moisture from humid outside air. The air present in the container when it is sealed is soon used up by grain respiration and any insects already present. For successful airtight storage:

- The grain should not be above 12-13 percent moisture.
- The containers must be made airtight by using metal, plastic, cement (with vapor barrier) or a waterproofing material like tar, oil-base paint or pitch.
- Containers should be filled to the top to exclude as much air as possible before sealing.
- Airtight storage should not be used where the containers must be frequently opened, since the added air will make the system ineffective for controlling insects.
- Containers, especially metal ones, should be shaded to prevent condensation and moisture migration.

Crib storage: See drying methods.

Insect Control In Stored Grain

Weevils and grain beetles feed on grain in both the adult and larval stages. In addition, the larvae of several types of moths attack the seeds. Aside from the actual losses due to feeding, storage insects promote mold and spoilage of grain by adding moisture and increasing temperature. A heavy infestation can increase grain moisture content by 5-10 percent within several months. Even if the grain does not spoil, it may be rendered unmarketable by the presence of insects or the physical damage caused by their feeding.

Grain can become infested both in the field and during storage. Some storage insects like the maize weevil, rice weevil, and angoumis grain moth which attack cereal grains and the bruchid beetles that attack pulses, have wings and can infest grain in the field. These and other types can also begin attacking grain during storage. The adults lay eggs on or in the grain, and the developing larvae hollow out the kernels.

Factors Favoring Infestation

- Temperature: This is the most important factor. As temperature increases from 10°C to 26 C, storage insect activity increases, and life cycles are reduced from about eight weeks to three weeks. At optimum temperatures, 50 insects could theoretically multiply to 302 million in just four months' Activity and breeding slows considerably below 10 C and above 35°C, and death occurs below about 5°C or above 59°C.
- Moisture: Storage insects prefer under-dried grain, but can still cause serious problems in grain as dry as 12-13 percent. Grain moisture content has to be 9 percent or below before activity ceases, and this degree of dryness is difficult to achieve and maintain.
- Storage practices: Storing new grain next to old grain or using storage facilities or sacks that have not been disinfected are sure ways of inviting infestations.

Types of Storage Insects and their Identification

It is useful to be able to precisely identify the types of insects attacking a farmer's grain for three reasons:

- Not all insects found in grain are serious pests. On the other hand, lack of visible grain damage does not necessarily indicate that the insects are harmless or minor pests, since it may take some weeks for damage to become apparent.
- Although control measures are fairly similar for most storage insects, there are some differences.
- Some storage insects are known as secondary and tertiary pests since they feed mainly on grain which is cracked or already damaged by primary pests. The presence of these non-primary pests often indicates that more serious pests are at work.

The Small Farm Grain Storage manual has a very complete identification guide to cereal grain pests, while the Insect Pests guide mentioned in the bibliography has pictures of both cereal and pulse storage insects.

Checking for Infestations

Early recognition of an infestation is very important for reducing potential grain losses. Stored grain should be closely checked every several weeks for signs of an insect buildup. Exit holes in the kernels, cobweb-like accumulations on sacks and maize ears, and the presence of adult insects are sure signs. When sampling grain, the farmer should examine kernels from various sections of the container or sack, since infestations often develop and spread from very localized areas or "hot spots" where temperature and moisture may be very high.

Controlling Stored Grain Insects

Early recognition of an infestation is very important for reducing potential grain losses. Stored grain should be closely checked every several weeks for signs of an insect buildup. Exit holes in the kernels, cobweb-like accumulations on sacks and maize ears, and the presence of adult insects are sure signs. When sampling grain, the farmer should examine kernels from various sections of the container or sack, since infestations often develop and spread from very localized areas or "hot spots" where temperature and moisture may be very high.

The Small Farm Grain Storage manual contains a detailed section on non-chemical and chemical controls for storage insects. A brief summary is given here plus some additional information from other sources.

Pre-storage Guidelines

- Be sure the grain is well dried and cleaned.
- Clean out and repair the storage facility. This includes sweeping out old grain and debris and patching all holes and cracks where insects might hide or moisture might enter.
- Spray or dust the facility with an approved insecticide (more on this further along).
- Disinfect used grain sacks before filling by boiling, spraying with an approved insecticide or placing them on a hot tin roof.

Non-Chemical Controls for Storage Insects

- Unhusked: Storing maize in the form of unhusked ears is somewhat effective.
- Sunning the grain: Beetles and weevils will leave grain if it is placed in the hot sun in a shallow layer. However, this usually will not kill all the eggs and larvae inside the kernels.

- Smoking the grain: By building a smoky fire under a platform or maize crib, many of the insects can be killed by both the smoke and heat.
- Mixing materials with the grain: Effectiveness varies with the substance used, but control can be quite good in some cases.
- Sand, burned cow dung, wood ashes, and lime give varying results. Sand helps exclude air by filling in the spaces. It also scratches the insects' shells which can lead to dehydration and death if the grain is already very dry (9-10 percent moisture). The other materials may have some insecticidal properties. It was discovered by CIAT that adding wood ash to bean seed at the rate of one part to three reduced bruchid weevil infestations by about 80 percent if applied before the insects appeared. Slaked lime (calcium hydroxide) or burned lime (calcium oxide added at 4-8 parts per 100 is also fairly effective (both types are caustic).
- Plants: In some areas, certain plants are known to have insecticidal properties and are mixed with the grain.
- Vegetable oil: The oils of peanuts, sesame, coconut, cottonseed, and mustard-seed have given excellent protection from bruchid infestation in beans and cowpeas when added at the rate of 0.5-1.0 percent (5-10 ml per kg of seed). Protection lasts for up to six months and does not affect the physical appearance of the grain since it is absorbed.
- Airtight storage: See storage methods.

Chemical Controls for Storage Insects

Grain that will be stored only a few weeks or even up to two to three months may not warrant the use of insecticides. However, the best time to treat grain is when it is first put into storage, before an infestation becomes serious.

CAUTION!: Some insecticides like Malathion, Lindane, Actellic, and Pyrethrins can actually be mixed with food grain without harmful effects or residues if used correctly. Many other insecticides would make the grain very toxic and unsuitable for consumption. Many farmers are not aware of these differences and in fact may refer to all insecticides by one name such as "DDT".

Where to obtain recommendations: The Small Farm Grain Storage manual gives recommendations for treating both grain and storage areas. However, storage insects vary in their susceptibility to different insecticides and resistance to Lindane and Malathion has become a problem in many areas. Actellic (pirimiphosmethyl) is a newer product that has proven very effective. Two other sources of information on storage insect control are:

African Rural Storage Center
IITA
PMB 5320
Ibadan, Nigeria

Tropical Stored Products Institute
London Road
Slough SL3 7HL
Bucks, England

RODENT CONTROL IN STORED GRAIN

The Small Farm Grain Storage manual contains a very complete section on rodent control.

Lessons of the "Green Revolution"

The "Green Revolution" of the 1960's and 1970's was really the first organized attempt to develop yield improving practices for staple food crops in the developing world. Most of the efforts of the Green Revolution were directed towards a number of the cereals, namely wheat, rice, and maize.

A major impetus was the development of short-strawed varieties of wheat, rice and maize that would respond well to high rates of fertilizer, especially nitrogen, without lodging.

The term "revolution" is really a misnomer; nearly two decades of plant breeding and local adaptive research were required before the new wheat and rice varieties were ready for widespread introduction in India and Pakistan. The true origins actually go back to breeding programs for wheat and maize in Mexico in the 1940's and to similar work with rice in the Philippines.

Supported by a "package" of complementary improved practices involving factors like fertilizer use, pest control, and plant spacing, the new varieties were adopted in many developing regions. By 1972-1973, some 33 million hectares in Africa and Asia were being sown to the high yielding wheat and rice varieties. Average yields were increased about 100 percent for rice compared with traditional varieties.

Despite these increases, the efficacy of the Green Revolution in overcoming hunger and rural poverty in the developing world is a hotly debated issue worthy of a manual in itself. There is no doubt that the Revolution has been the major factor behind the gains in food production in many developing countries during the past 15-20 years and has also laid a solid basis for additional agricultural research in the region. It was conducted in a spirit of humanitarian and largely apolitical international cooperation that should be commended.

On the other hand, it has not proved to be the hoped-for panacea for several reasons:

- The high yielding variety (HYV) "packages" it developed required relatively high levels of inputs (fertilizers, pesticides, and, in some cases, irrigation pumps) and investment. At least initially, the smaller farmers were often bypassed due to deficiencies in the infrastructure that made it difficult for them to obtain both the credit and the inputs. Unless special provisions were made to provide small farmers credit, lending institutions naturally favored the larger ones. This situation has improved considerably over the past decade in many areas, but is still a serious problem.
- The high costs of these inputs, some of which are very petroleum-dependent (i.e. nitrogen fertilizer and pumping fuel), raises doubts about their continued practicality, especially in view of the current energy crisis. Fertilizer rates are often well above the threshold of diminishing returns in the case of nitrogen and phosphorus; the latter is a non-renewable resource with limited world reserves. Fortunately, there is a growing awareness of the need for an appropriate technology in harmony with both the environment and economics.
- An important lesson learned is that increased production does not automatically improve rural wellbeing. In some parts of India, for example, the HYV package actually had a negative effect on income distribution, rural employment, and dietary habits. A disturbing number of small landholders and tenant farmers were squeezed off the land by the new production economics, and urban industrialization was insufficient to provide them employment. Cereal cropping was favored over grain legumes, sometimes resulting in actual declines in pulse production and consumption. With a bad case of Western economic ethnocentricity, many "experts" argued that this was the necessary price to pay for modernizing agriculture along "big is better" lines.

Fortunately, there is a growing realization that the small farmer must be included in agricultural development which should be tied into integrated rural development so that nutrition, health, education and general rural welfare are also considered. In fact, as the small farm family's income and production increases, receptivity to these other programs is usually enhanced.

The Green Revolution is far from over. Rather, its goals are being redefined and extended to other food crops. Future progress will largely depend on how the developing world handles two key issues:

- The conservation of natural resources and the total environment.
- Choosing appropriate scales of production: The Western bias is that "big is better", yet evidence strongly suggests that small, intensively cultivated units are the most efficient. This brings up the issue of agrarian reform, as well as the ultimate goals of agricultural development. The conventional approach of trying to integrate the small farmer into a modern agribusiness system usually fails (as it did in the U.S.). Others feel the goal should be to enable the marginal small farm family to achieve self-sufficiency with a small surplus left over for education and general welfare.

Agricultural extension workers will have a central role in this effort to extend the benefits of the Green Revolution. By spreading the knowledge gained in trials conducted by the major research institutes to increase production of traditional crops, agricultural extension workers will help ensure that the Green Revolution truly serves to improve the lives of small farmers and their families in the developing world.

Appendices

Appendix A - Measurements and conversions

Area

1 HECTARE (ha) = 10,000 sq. meters = 2.47 acres = 1.43 manzanas (Central America)
 1 ACRE = 4000 sq. meters = 4840 sq. yards = 43,560 sq. ft. = 0.4 hectares = 0.58 manzanas (Central America)
 1 MANZANA (Central America) = 10,000 sq. varas = 7000 sq. meters = 8370 sq. yards = 1.73 acres = 0.7 hectares

Length

1 METER (m) = 100 cm = 1000 mm = 39.37 inches (in.) = 3.28 feet (ft.)
 1 CENTIMETER (cm) = 10 mm = 0.4 in.
 1 INCH (in.) = 2.54 cm = 25.4 mm
 1 VARA (Latin America) = 32.8 in. = 83.7 cm
 1 KILOMETER (km) = 1000 m = 0.625 miles
 1 MILE = 1.6 km = 1600 m = 5280 ft.

Weight

1 KILOGRAM (kg) = 1000 grams (g) = 2.2 pounds (lbs.) = 35.2 ounces (oz)
 1 POUND (lb.) = 16 oz. = 454 g = 0.45 kg
 1 OUNCE (oz) = 28.4 g
 1 METRIC TON = 1000 kg = 2202 lbs.
 1 LONG TON = 2240 lbs; 1 SHORT TON = 2000 lbs.
 1 QUINTAL = 100 lbs. (Latin America); 112 lbs. (British); 100 kg (metric)

Volume

1 LITER (l) = 1000 cubic centimeters (cc) = 1000 milliliters (ml) = 1.06 U.S. quarts
 1 GALLON (U.S.) = 3.78 liters = 3780 cc (ml)
 1 FLUID OUNCE = 30 cc (ml) = 2 level tablespoons (measuring type)

Miscellaneous Conversions

Lbs./acre X 1.12 = kg/ha; lbs/acre X 1.73 = lbs/manzana
 Kg/ha X 0.89 = lbs./acre; kg/ha X 1.54 = lbs./manzana
 Lbs./manzana X 0.58 = lbs./acre; lbs./manzana X 0.165 = kg/ha

Temperature:

$$C^{\circ} = (F^{\circ} - 32) \times 0.55$$

$$F^{\circ} = (C^{\circ} \times 1.8) + 32$$

Appendix B - How to conduct a result test

When is Result Testing Needed?

- To test responses to an improved practice under actual farming conditions: Research station conditions are often more ideal or at least different from actual on-farm conditions. What works well under the more controlled situation of the station may be less than satisfactory in farmers' fields where soil and management are likely to be much less than optimal.
- To test responses in different geographic regions
- To measure the profitability of a new practice
- To measure the variability of results: Farmers are just as interested in the variability of benefits from a new practice as they are in the average benefit. A practice that produces large benefits on some farms but little or none on others is unlikely to gain wide acceptance.

The Procedure

- Clearly describe the practice to be tested
- Divide the test region into zones: The work area may have significant variations in soils, rainfall, elevation, farming systems, etc. It is important to divide the testing region into separate zones if they differ enough from each other to warrant separate recommendations. The number of zones will depend on your area's diversity, the complexity of the practice you are testing, and time and budget limitations. In most cases you will be dealing with no more than two to three test zones within a municipality.
- Decide on the number of farms to be included per test zone: Naturally, the more tests and farms that are included per test zone, the more representative the results will be and the more specific will be the recommendation that follows. However, costs will be higher and so will time requirements.

Two factors determine the number of farms that should be included in a test area:

- If high average benefit is expected from the new practice as opposed to the traditional one, fewer farms need to be included than if the average benefit is lower.
- If a large variation is expected in farm to farm results, more farms need to be included than if a smaller variation is expected,

NUMBER OF FARMS TO INCLUDE IN A RESULT TEST

If you expect an average increase over normal yields of:	And if you expect yield variation between farms within the region to be:	Then you should include this number of farms in your test: (10 maximum)
100 percent	Quite variable	6
	Fairly consistent	4
50 percent	Quite variable	9
	Fairly consistent	5
25 percent	Quite variable	10
	Fairly consistent	6

Extension workers ideally should consult an experienced researcher or extension officer in deciding how many farms to include in a result test. If professional advice is not available it may be better to proceed with result tests using less precise sampling methods. The table below is based on a 500-1000 farm work area.

- Decide on how long to run a result test: If the expected benefits of the new practice are likely to be significantly related to weather conditions during the growing period, the test should be repeated over several years. This is often the case with tests involving fertilizer use and changes in plant density and tends to be true with most other practices, at least to some extent. Repeat testing is especially indicated if the first trial takes place during an unusual weather year. Long-term weather records can help determine this, but if not available, local extensionists and farmers can be of help.
- Select individual farms: It is important that selected farms be representative rather than "typical". The participating farms should reflect a cross-section of those in the test area so that trial results can be converted into recommendations generally suitable for the entire area. Remember also that you should be just as interested in determining the variation of response among farms as in the average overall response. Farmers do not harvest averages'

Ideally, the farms should be chosen at random, but this is never completely practical due to the limitations imposed by accessibility and farmer cooperation. However, the less the choice of farms is confined to a particular class of farms and the more you choose farms on an "as they come" basis, the closer you will be to achieving a valid representation.

This principle is much easier to violate than one might expect. For instance, it is easier to work with farms close to a road, with familiar farmers or with farms where good results can be expected. Such biases can totally discredit the results.

- Decide what kind of control plot is needed: If the result test is to compare an old practice with a new one, a control or check plot will be necessary. However, if a totally new crop is being introduced rather than a new practice or new variety, no control plot is needed.
- Choose the location and size of the plots: Plot location will depend a lot on the feelings of the cooperating farmer. This is no problem, as long as he or she does not purposely select the best piece of ground on the farm. Random choice is the best method here unless parts of the farm have been subjected to very unusual management practices such as ultrahigh fertilizer applications. Both the test plot and the control plot should be in the same field and preferably adjoining each other. This helps ensure that both plots are subjected to the same variables. In fact, it may be best to avoid using farms where the two plots cannot be located in the same field.

The plots should be large enough so that the usual farming methods can be followed, yet small enough so that the results are clearly visible. The test and the control plot do not have to be the same size. The test plot can be a portion of it serving as the control plot.

- Conducting and supervising the test: The farmer and his or her usual extra workers should handle all the land preparation, planting, weeding, and other operations normally associated with the crop. They should also apply the new practice themselves under the guidance of the extension worker(s). This assures that the result test is fully representative of actual farming conditions.

Make sure that all variables other than the practice or input being tested are held constant. One common error of both farmers and extensionists is to take better care of the test plot than the control plot. Such preferential treatment can completely invalidate the results.

Documentation is vital. All inputs used should be measured and recorded to the extent possible. Weather data such as rainfall, hail, and unusual temperature extremes should also be recorded if possible along with any visual differences between the test and control plot during growth.

- Collecting Data: No conclusions can be drawn from the result tests until yields have been measured. The goal is to weigh the harvest from the test plot and an equal area of control plot. The extensionists and the farmer should decide on a harvest date and arrangements should be made to obtain an accurate scale. Gross yields from both plots can be measured at the same time and then converted to a kg/ha, lbs./ acre or other locally used yield standard.

However, you should always obtain a yield sample prior to the actual harvest date just in case the plots are inadvertently harvested without measuring yields before the agreed upon date. A properly collected random yield sample is usually accurate within 5 percent of the actual yield and is a cheap insurance policy.

- Analysis of the results: Good records are essential to any valid analysis of the results. By far the best way of interpreting the results is to run a standard statistical analysis of the yield data. You do not need formal training in statistics to do this. Appendix F gives easy to follow instructions for carrying out a statistical analysis which will enable you to determine the standard deviation (a measure of the variability of responses from the average).

Calculate the standard deviation, since it serves as basis for giving realistic yield expectations when making recommendations to farmers.

Reducing the Risk To Participating Farmers

- Subsidizing inputs:

Result tests: There are two schools of thought here. Some extension specialists feel that all new inputs for the test plots should be provided free to the farmer. They feel this makes it easier to find collaborators and also helps assure control over the plots. Others feel that no compensation should be given unless a completely new or unknown input is involved, Much of the choice depends on the economic condition and receptiveness of the local farmers.

Result demonstrations: Inputs should ordinarily not be subsidized unless there is still some uncertainty about the profitability of the new practice, in which case it probably should not be at the demonstration phase anyway.

NOTE: If subsidies are provided, be sure to include the true costs of the inputs when doing a cost/benefit study.

- Reducing the number of farm tests :

Result tests: Reducing the number of tests may make the test results unrepresentative for the area.

Result demos: Reducing their number will not affect the demonstration principle, but may slow the rate of mass acceptance by farmers.

- Reducing plot size:

Result tests: Plot size should be large enough to allow normal growing practices to be followed. Rather than cut plot size below this limit, subsidies should be offered.

Result demos: Let the farmers choose their own plot sizes as long as normal growing practices can be followed.

- Guaranteeing the price or the yield: The extension agency may guarantee a certain yield or market price to a cooperating farmer, perhaps in the form of a purchase contract. This should only be done with result tests. Demonstrations should stand on their own.

Appendix C - How to conduct a result demonstration

Examine the Recommendation that Will be Demonstrated

Make sure that the recommendation is:

- Adapted to local growing conditions.
- Within the economic means of most of the local farmers.
- Adequately tested under local farming conditions

Select Demonstration Sites

Since the goal of a result demonstration is to promote acceptance

Since the goal of a result demonstration is to promote acceptance of a new practice on a mass scale, the main concern is maximum effective exposure when selecting sites. However, if the recommendation involved is suited to several types of soils or other variations commonly found in the local area, be sure to include some farms in each category. Here are some selection guidelines:

- Choose Key Farmers

These are not necessarily the best or the most progressive farmers, since these may be regarded as being too exceptional by other farmers. Do not turn down a "progressive" farmer, but concentrate on seeking out influential farmers.

- Chose Conspicuous Sites

Sites should be near roads, trails or public gathering places.

- Group Demonstrations on Rented or Donated Land

These can be very effective, but the group should be a pre-existing one, rather than being specially organized on-the-spot to conduct the demonstration.

- Special Factors in Fertilizer Demonstrations

Do not use a field that has received unusually heavy rates of fertilizer in the past. Fertilizer demonstrations give the most spectacular visual responses and yield differences on low fertility land, but do not purposely seek out unusually poor land for the demonstration,

- The "Spontaneous" Demonstration: Another approach which can be very effective in certain cases is to look for a farmer's field that already demonstrates the value of what you are trying to promote. One disadvantage is that there is usually no control plot for comparison.

Preparing for The Demonstration

After selecting the sites, the extension worker should discuss the demonstration with the farmer, including the approximate dates of important operations such as planting, fertilizer application, etc. Make sure the necessary inputs are on hand. The extensionist should thoroughly understand the what, how and why of the procedures involved in preparing and growing the demonstration plot.

Supervision and Management

The extensionist should be present during the application of any new procedure(s) involved with the demonstration plot to assure that the farmer does them correctly. To make the demonstration realistic, the farmer and his or her usual help should do most of the work.

Avoid the strong tendency to favor the "new practice" plot through overly careful tending or protecting it from limiting factors without regard to cost. Visiting farmers can often easily spot these atypical factors, which may seriously affect the demonstration promotional value.

Observation And Records

The main objective of demonstration plots is to promote improved practices, but they can also provide some very useful information in return for the small amount of extra work required to keep records and accurately measure yields. Here are some suggestions:

- Maintain some kind of chronological record of each demonstration, noting such things as date and amount of input application, weather conditions, visual observations, etc.
- Make a yield estimate using the random sample technique explained in Appendix L.
- Check these estimates with what the participating farmers claim for their yields.

Promotion and Followup

Demonstrations are supposed to serve as "living" examples of the benefits of an improved practice (or "package of practices"). Neighboring farmers should be invited to see the demonstration during the crop's growth at any time when the desired results can be clearly seen (such as larger, greener plants resulting from fertilizer use). Final yield results should be discounted conservatively.

Organized sessions for visiting farmers should be arranged if the new practice requires explanation or new skills, both of which are very likely. This is known as a method-result demonstration and such a session should be conducted by a qualified and locally-experienced extension worker fluent in the local language.

The real test of a demonstration is how rapidly farmers begin to adopt the new practice.

SOME CAUTIONS:

- Do not use a result demonstration to test the outcome of a recommendation. That is what a result test is designed to do. Result demonstrations are for promoting practices that have already been largely locally proven. Never undertake a result demonstration unless you are reasonably sure the practice is beneficial.
- Do not promise too much in the way of results. Be conservative.
- Do not run a demonstration on your own land.
- Do not sacrifice quality of work for quantity of work.
- Do not favor one demonstration over another.

Appendix D - How to conduct an elementary statistical analysis

A result test consists of a number of individual trials on representative farms within a local area in order to compare a new practice with an old one. The results of these trials provide the final basis for making specific, locally adapted recommendations to farmers. In order to correctly interpret a result test, the yield results must be given at least an elementary statistical analysis to determine the two most important measures of the new practice's actual benefits:

- The average benefit: This is the average yield increase of the new practice over the old practice.
- The standard deviation: This indicates how much the individual results vary from the overall averages. It is the indicator of the variability of responses around their average. Remember that farmers seldom harvest "averages" and are very interested in knowing the likely variation in benefits.

The calculations are not difficult if you follow these standard procedures:

1. Arrange the data in column form, as in the table on the next page.
2. Calculate the following averages by adding up the appropriate columns and dividing by the number of individual trials involved. (Refer to table on the next page.)
 - a. Average (mean) yield for the old (control) practice.
 - b. Average (mean) yield for the new practice
 - c. Average benefit: the average yield increase of the new practice compared to the old one.

3. The Square of the Benefit: This is a standard statistical procedure used to calculate the standard deviation. However, the differences between the squares of the individual benefits have no significance. What is important is the sum of the squares, since it is from this that the standard deviation is determined.

4. Calculate the standard deviation: It is the most important statistic you will derive from the results since it shows the variability of responses from the average. The procedure for calculating the standard deviation is best shown by the following example.

5. Summarize the Data

- a. Average yield of the new practice: 23.6 but/acre
- b. Average yield of old practice (control or check plot): 17.2 but/acre
- c. Average benefit (new over old practice): 6.5 but/acre
- d. Standard deviation 2.8 but/acre or 16%

6. Interpret the Data: Once the average benefit and the standard deviation has been calculated, you can answer four key questions which are used to come up with a recommendation based on the test results:

- a. What was the average increase in yield from the new practice?

Solution using the data ill Step 5: $[6.5 / 17.2] \times 100$ 38%

- b. What is the minimum increase in yield that farmers can expect three out of four times?

Solution: Multiply the standard deviation as a percentage (16%) by 0.7, a mathematical constant used in statistics. Then subtract the result from the average increase in yield expressed as a percentage (38%).

Solution using above data:

$$16\% \times 1.0 = 16\%$$

$$38\% - 16\% = 22\% \text{ increase}$$

Data from a Maize Variety Test on 25 Farms

Farm	YIELD		BENEFIT	SQUARE OF BENEFIT	
	New Practice	Control			
	Bushels/acre	Bushels/acre	Bushels/acre		
1	23	16	7	(7) ²	49
2	37	26	11	(11) ²	121
3	24	17	7	(7) ²	49
4	20	14	6	(6) ²	36
(5-21)					
22	24	17	7	(7) ²	49

23	22	16	6	(6) ²	36
24	28	21	7	(7) ²	49
25	26	19	7	(7) ²	49
SUMS	591	429	162		1236
AVERAGES	23.6	17.2	6.5		

How to Calculate the Standard Deviation

- a. Sum of the squares of the benefit = 1236 bushels
- b. (Sum of the benefits) / number of farms = (162) / 25 = 1050 bushels
- c. Subtract (b) from (a): 1236 - 1050 = 186 bushels
- d. The difference (c) / Number of farms - 1 = 186 / 24 = 7.75 bushels
- e. Standard deviation = square root of (d) or (7.75)^{1/2} = 2.8 bushels
- f. [Standard deviation (e) x 100] / Average yield of the control = [2.8 x 100] / 17.2 = 16%

Therefore: 16% = the standard deviation (variation) as a percentage of the average yield under the old practice (control).

- c. What is the minimum increase in yield that farmers can expect three out of four times?

Solution: Multiply the standard deviation as a percentage (16%) by 0.7, a mathematical constant used in statistics. Then subtract the result from the average increase in yield expressed as a percentage (38%).

Solution using above data:

16% x 1.0 = 16%
 38% - 16% = 22% increase

- d. What percent of the farmers are likely to get no increase in yield from the new practice?

Solution: Divide the average benefit by the standard deviation to obtain a ratio. Then look up the answer according to this ratio in the following table, interpolating if needed.

Solution using above data:

6.5 but / 2.8 but = 2.3 (ratio)

Answer = 1% of farmers

Ratio	Answer (percent)
2.6	Fewer than 0.5%
2.3	1%
2.0	2%
1.6	5%
1.3	10%
1.0	15%
0.8	20%
0.7	25%

7. Interpreting the Results on an Economic Basis

Since most new practices involve increased costs, the real test of their benefits is the increase in net returns over the increase in costs. The same statistical procedures used above can also be applied to the net economic benefit and the cost/benefit ratio tests.

Appendix E - How to convert small plot yields

When dealing with yields from field trials, demonstration plots, and farmers' fields, you will usually want to convert them to a kg/ha, lbs./acre or other standard basis. There are several easy ways to do this, and they are best shown by example.

PROBLEM 1: Pora harvests 300 kg of shelled maize off a field measuring 30 X 40 meters. What is her yield on a kg/ha basis?

SOLUTION

Method 1:

10000 sq. m (1 hectare) / plot area in sq. m _ plot yield in kg = yield in kg/ha

10000 sq. m _ 1200 sq. m _ 300 kg = 2500 kg/ha of maize from Pora's field

Method 2: Make a proportion

$$\frac{\text{Area}_1}{\text{Area}_2} = \frac{\text{Yield}_1}{\text{Yield}_2}$$

$$10000 \text{ sq. m} / 1200 \text{ sq. m} = Y_1 / 300 \text{ kg}$$

To solve the proportion for Y_1 , cross multiply like this:

$$1200 Y_1 = 300 \text{ kg} \times 10000.$$

Then solve for Y_1 :

$$Y_1 = [300 \text{ kg} \times 10000] / 1200$$

$Y_1 = 2500 \text{ kg/ha}$ of maize from Pora's field

PROBLEM 2: Lam harvests 150 lbs. of dried cowpea seed off a field measuring 45 X 75 feet. What is his yield in terms of lbs. per acre?

SOLUTION

Method 1: 43560 sq. ft. (1 acre) / plot area in sq. ft. _ plot yield in lbs. = yield in lbs./acre

43560 sq. ft. / 3375 sq. ft. _ 150 lbs. = 1936 lbs./acre of cowpeas from Lam's plot

Method 2: Make a proportion

$$\frac{\text{Area}_1}{\text{Area}_2} = \frac{\text{Yield}_1}{\text{Yield}_2}$$

$$\frac{43560 \text{ sq. ft.}}{3375 \text{ sq. ft.}} = \frac{Y_1}{150 \text{ lbs.}}$$

Then cross multiply and solve for

Y_1 like this:

$$3375 Y_1 = 150 \text{ lbs.} \cdot 43560$$

$$Y_1 = \frac{150 \times 43560}{3375}$$

$Y_1 = 1936 \text{ lbs./acre}$ of cowpeas from Lam's plot

NOTE: You can "mix" units of measure from different systems if you know the conversions. Examples:

1 Acre = 400 sq. m

1 Manzana (Central America) = 1.73 acres = 0.7 ha = 7000 sq. m

Appendix F - How to take soil samples

1. Divide the Farm into Sampling Units: Each sample sent to the lab is really a composite sample made up of 10-20 sub-samples taken from an area that is uniform in color, texture, topography, past management, and other characteristics that may influence soil fertility. A farm may have several of these distinct areas which are referred to as sampling units.

Begin by drawing a map of the farm land to be sampled, and then divide it into separate sampling units according to the above criteria. Each sampling unit should contain only one type of soil (that is, do not combine red soil with black soil, hill soil with level soil, fertilized soil with unfertilized soil, etc.). It is important to have a good idea of the land's fertilizer and liming history to avoid variations within one sampling unit.

Map

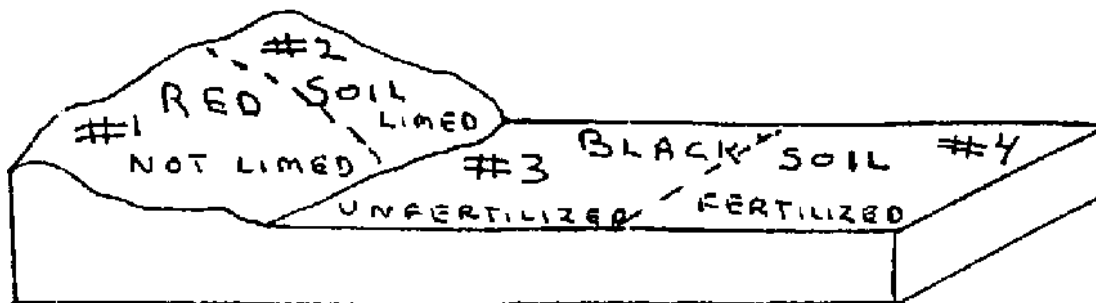

The final map with numbered sampling units might look like this:

Size of sampling units: A sampling unit should usually not exceed 4-6 ha. Of course, small farms will have much smaller sampling units.

2. For each sampling unit, collect sub-samples for making a composite sample representing that unit.

- If the farm has three sampling units, the farmer will send in three soil samples to the lab. Each sample will consist of 10-20 sub-samples taken at random within the sampling unit.
- Depth of sampling: Most labs want topsoil samples only about 15-20 cm deep. When sampling fields to be used for pasture, a 5 cm depth is sometimes requested by the lab. Avoid including any subsoil in a topsoil sample unless the topsoil layer is very thin because of erosion.

- To take a sub-sample: A shovel and a machete can be used, although a soil auger is better when the ground is very hard.

If using a shovel, make a hole with 45° sides to the right depth and then carefully dig out a slice about 3-5 cm thick. The slice should extend to the appropriate vertical sampling depth and be uniform in thickness. Holding the face of the soil slice with your hand will keep it from crumbling apart. Scrape off any surface litter before sampling.

Trim down the width of the soil sample on the shovel with the machete until it is about 4-5 cm wide and then dump it in a pail.

Sampling guidelines: Do not take sub-samples from fertilizer bands, under animal droppings or along a fence line or extreme end of a field. Use a thoroughly clean pail that has not been used to hold fertilizer. Galvanized pails will make zinc tests inaccurate.

- Preparing a composite sample: After collecting the 10-20 random sub-samples within one sampling unit, thoroughly mix them in the pail and then take out enough soil to fill up the soil sample box.

Guidelines: Never mix soil from different sampling units. Do not oven dry wet samples, because this will cause a falsely high potassium reading in the test. Air dry them instead. Clean out the pail completely before moving to another sampling unit.

- Fill out the informal sheet: The form from the soil laboratory will request information about the soils' slope, drainage, cropping history and yields, past applications of fertilizers and lime, crops to be grown and desired yields.

When to take soil samples: Send them in at least two months before you need the results. In areas with a concentrated planting season, farmers tend to wait until the last minute to send in samples, and the lab is unable to process all of them on time.

How often is testing needed? Under low to moderate rates of fertilizer use, a field should be sampled about once every three to five years, since the soil's fertility level is unlikely to change significantly on a year-to-year basis. This is fine, since farmers with limited capital should concentrate on feeding the present crop rather than building up the soil's general fertility level.

Appendix G - Hunger signs in the reference crops

Nitrogen

Maize, Sorghum, Millet

Young plants are stunted and spindly with yellowish-green leaves. In older plants, the tips of the lower leaves first show yellowing which progresses up the mid-rib in a "V" shaped pattern, while the leaf margins remain green. In some cases, a general yellowing of the lower leaves occurs. In severe cases, the lower leaves soon turn brown and die from the tips down. (This "firing" can also be caused by drought which prevents N uptake.) Maize ears are small and pinched at the tips.

Legumes

The lower leaves begin to turn light green and then yellow with the symptoms progressing gradually upward. Plant growth is stunted.

Phosphorus

Maize, Sorghum, Millet

Hunger signs are most likely during early growth. Mild shortages usually cause stunting without clear leaf symptoms. More severe shortages cause a purplish color starting at the tips of the lower (older) leaves which may begin to turn brown and die. Some varieties of maize and sorghum do not show a purplish color but rather a bronze coloration of the same pattern. Disregard purple stems.

In maize and sorghum, symptoms usually disappear once the plants reach 40-45 cm, but yields will be severely lowered. Maize ears from P-deficient plants are somewhat twisted, have irregular seed rows, and seedless tips.

Legumes

Phosphorus hunger signs often are not well defined. Plants lack vigor and have few side branches. Upper leaves become dark green, but remain small. Flowering and maturation are retarded.

Potassium

Maize, Sorghum, Millet

The three crops rarely show symptoms the first several weeks of growth. The margins of the lower leaves turn yellow and die, starting at the tip. Potassium-deficient plants have short internodes and weak stalks. Maize stalks sliced lengthwise often reveal nodes that are a darkish brown. Maize ears from potassium-deficient plants are often small and may have pointed, poorly seeded tips.

Legumes

Potassium deficiency is seldom seen in beans, but can occur in highly infertile soils or those high in calcium and magnesium. Symptoms are yellowing and death of leaf tips and margins, beginning on the lower leaves and gradually moving upwards.

Calcium

Beans

Calcium deficiency in beans is uncommon, but most likely to occur in combination with aluminum toxicity in very acid soils. Leaves stay green with a slight yellowing at the margins and tips. Leaves may pucker and curl downwards.

Peanuts

Light green plants with a high percentage of "pops" (unfilled pods) show symptoms of calcium deficiency.

Magnesium

Maize, Sorghum, Millet

A general yellowing of the lower leaves is the first sign. Eventually, the area between the veins turns light yellow to almost white while the veins remain fairly green. As the deficiency progresses, the leaves turn reddish-purple along their edges and tips, starting at the lower leaves and working upward.

Beans

Most likely in acid soils or those high in Ca and K. Yellowing between the veins appears first on older leaves and then moves upward. Leaf tips show the first effects.

Sulfur

Where to suspect: Sulfur deficiencies may be suspected where there are volcanic or acid, sandy soils, and where low S fertilizers have been used for several years.

Maize, Sorghum, Millet

These crops have relatively low S needs. Stunted growth, delayed maturity, and a general yellowing of the leaves (as distinguished from N deficiency) are the main signs. Sometimes, the veins may stay green which may be mistaken for zinc or iron deficiency. However, iron and zinc hunger are more likely in basic or only slightly acid soils.

Beans

Upper leaves become uniformly yellow.

Zinc

Zinc deficiencies occur where soil pH is above 6.8 and high rates of P are used, especially if placed in a band or hole near the seeds.

Maize

Maize shows the most clear-cut zinc hunger signs of all crops. If severe, symptoms appear within two weeks of emergence. A broad band of bleached tissue on each side of the midribs of the upper leaves, mainly on the lower part of the leaves, is typical. The mid-rib and leaf margin stay green, and the plants are stunted. Mild shortages may cause a striping between the veins similar to manganese or iron deficiency. However, in Fe and Mn shortages, this interveinal striping runs the full length of the leaf.

Sorghum

Similar to maize, but less interveinal striping, and the white band is more defined.

Legumes

Interveinal yellowing of the upper leaves.

Iron

Iron deficiencies can be suspected where soil pH is above 6.8.

Maize, Sorghum, Millet

Sorghum is much more prone to iron deficiency than maize. All three crops show an interveinal yellowing that extends the full length of the leaves and occurs mainly on the upper leaves.

Legumes

Interveinal yellowing of the upper leaves occurs. They eventually may turn uniformly yellow.

Manganese

Where to suspect: Manganese deficiencies are uncommon in maize, millet, or sorghum. It occurs in soils which have a pH of 6.8 or above and in sandy or heavily leached soils.

Peanuts

Yellowing between the veins of the upper leaves which eventually turn uniformly yellow and then bronze is a symptom.

Beans

Plants are stunted. Upper leaves become yellow between the small veins and eventually take on a bronzed appearance.

Manganese toxicity occurs on very acid soils and is accentuated by poor drainage. Beans are very susceptible. The upper leaves show an interveinal yellowing. Easily confused with Zn or Mg deficiency, but Zn deficiency is very uncommon in highly acid soils.

Boron

Where to suspect: Boron deficiencies can be suspected in acid, sandy soils or high pH soils. Beans and peanuts are the most susceptible of the reference crops.

Peanuts

Foliage may be normal, but kernels often have a hollowed out, brownish area in the meat. This is usually referred to as "internal damage".

Beans

Thick stems and leaves with yellow and dead spots. If less severe, leaves are puckered and curl downward. Easily confused with leafhopper or virus attack. In very severe cases, plants stay stunted and may die shortly after emergence. Boron toxicity can be caused by applying a fertilizer containing boron too close to the seed row or by applying B non-uniformly. Symptoms are yellowing and dying along the leaf margins of the plants shortly after emergence.

Appendix H - Miscellaneous pulses

Chickpeas

Other names: Garbanzo, gram pea

Scientific name: *Cicer arietum*

Main areas of production: 90% of the world's production occurs in India and Pakistan, but chickpeas are also an important crop in Lebanon, Turkey, Syria, Iran, Bangladesh, Burma, Nepal, Colombia, Argentina, and Chile.

Adaptation, Characteristics

Chickpeas prefer cool, semiarid conditions. The seeds have a very permeable coat and lose their viability (germination ability) quickly under high humidity. The crop has a very deep root system and is a very efficient extractor of soil phosphorus. It has good nitrogen fixing ability.

Uses and Nutritive Value

Chickpeas are consumed as immature seeds (and pods) or as mature seeds. Also used as a coffee substitute after roasting. The seeds contain about 70 percent protein.

World chickpea production averaged around 7 million tons/year during the 1975-1977 period and was largely concentrated in India and Pakistan.

Pigeonpeas

Other names: Gandul

Scientific name: *Cajanus cajan*

Main areas of production: India, the Caribbean (especially the Dominican Republic and Puerto Rico), Colombia, Panama, Venezuela, the Middle East, and parts of Africa.

Adaptation, Characteristics

This is a woody, erect, short-lived perennial which can reach a height of three to four meters. Pods are pea like and flair, with three to seven seeds. Seed color varies from white to red or almost black. Plants can be used as a windbreak. Pigeonpeas are very drought resistant and tolerate a wide variety of soils and rainfall conditions. They are usually treated as an annual or biennial and pruned to encourage branching after each crop. They are often interplanted with maize, sorghum, millet, beans, and squash. Early varieties take 12-14 weeks until pod initiation and a total of five to six months to maturity.

Late varieties take about 9-12 months. Although the plants will grow for three to four years, yields tend to decline. It is often best to treat it as an annual or to slash it back and take ratoon crops using the cut branches and leaves as live feed.

Regional figures are not available for pigeonpea production, but worldwide production probably totals about half that of chickpeas.

Green pod yields range from about 1000-4000 kg/ha with up to 8000 kg/ha possible. Yields of dry seeds average about 600-1100 kg/ha, but up to 2000 kg/ha is possible. The plants are very efficient nitrogen fixers.

Nutritive Value and Uses

Both the dry seeds and the young green ones (sometimes with the pods) are eaten. Mature dry seeds contain about 20 percent. The dried stalks and branches are used for firewood, thatching, and baskets. The crop is also valuable as a forage, windbreak and green manure (organic fertilizer) crop, and for soil erosion control on slopes.

Lima beans

Scientific name:

Main areas of production: One of the most widely grown pulses in both temperate and tropical areas. Lima beans are the main pulse crop in the wet rainforest regions of tropical Africa and Latin America. Extensively grown in Liberia, Burma, and Nigeria.

Types

Most breeding research has focused on the erect, non-vining bushy types with strong stems and a self-standing ability. However, these bush varieties are not well adapted to hot, humid conditions like the vining types of limes.

Adaptation, Characteristics

The vining varieties require a support crop or other form of staking. They tolerate wetter weather during growth than cowpeas or common beans but need dry weather during the late stages when harvested in the mature form. Limas are less drought-tolerant than many other legumes and are very sensitive to soil acidity (the optimum pH is about 6-7). Varieties are either day neutral or short-day in their response to day length. Vining types have been grown up to elevations of 2400 m in the tropics.

Nutritive Value and Uses

Lima beans are grown mainly for the dry, shelled beans, but the immature seeds are sometimes cooked as a vegetable along with the pods and leaves. Some varieties have a dangerous level of hydrocyanic acid (HCN) in the leaves, pods, and seeds, but this can be dissipated by boiling and changing the cooking water. Colored seed varieties are higher in HCN than white ones.

The plants also are used as a green manure crop and as a cover crop (to protect the soil from erosion). The seeds contain about 20 percent protein in the mature, dry form.

Mung beans

Other names: Golden gram, green gram

Scientific names: Phaseolus aureus

Mung beans are an important crop in India, China, and the Philippines and have been introduced into other areas. They are fairly drought tolerant but susceptible to poor drainage. They are eaten as boiled mature seeds, green pods or sprouts. The crop is also used for forage, green manure or as a cover crop. Mung beans are efficient nitrogen fixers.

Soybeans

Scientific name: Glycine max

The most extensive areas of soybean production are in the U.S., Brazil, Argentina, China, and other parts of Southeast Asia, although the crop is grown in many other areas worldwide. Its reputation as a high protein crop (35-40 percent protein) has tempted many Volunteers to introduce the soybean to their work areas. However, one should be aware of the following potential problems:

- Local pulses may be better adapted to the area. Soybeans do not tolerate soil acidity well and prefer a pH between 6.0 and 7.0. High rainfall and humidity encourages diseases and insects.

The crop is largely grown for export and for making soybean oil and meal, the latter used in livestock feed.

- Cooked soybeans often have an unpleasant off-flavor or odor which can make them unpalatable to many people. However, the University of Illinois has developed an inexpensive cooking method that solves this problem. Peanuts have the advantage over soybeans of being both a cash crop and a food crop and are also more drought-tolerant.

- As with some sorghums and millets, soybeans are highly photosensitive to daylength, and varieties have a very narrow range of adaptation north and south of their origins. U.S. Corn Belt varieties are normal; grown under very long summer daylengths and if moved to short day tropical areas, they become dwarfed and reach maturity much too quickly. However, varieties are available for tropics.

- While soybeans are an extremely efficient nitrogen fixer, they require a unique type of Rhizobia bacteria unlikely to be present in soils not previously cropped to soybeans. In such cases, the seed needs to be inoculated with a commercial strain of Rhizobium japonicum. Soybean Rhizobia are adversely affected by soil pH's much below 6.0.

Winged beans

Scientific name: Phophocarpus tetragonalobus

Winged beans are not a row crop, but have received much publicity as a possible "wonder crop." In the interest of clarification, some basic facts are presented here.

The plants are twining vines that grow to over three meters when supported and produce pods with four longitudinal jagged "wings" that contain up to 20 seeds. Winged beans are adapted to the wet tropics and have some valuable characteristics:

- The dry seeds contain about 34 percent protein and 18 percent oil which makes them about equal to soybeans. The young leaves and pods can be eaten too.

- Some varieties produce edible tubers with a reputed protein content of 20 percent, although some investigators feel that this is considerably overestimated.
- They are a very efficient nitrogen-fixing legume and produce good yields. Yields of up to 2500 kg/ha of mature dry seed have been reported.

Now for some of the disadvantages of winged beans:

- The plants must be staked or they will not flower well, although they can be grown prostrate for their tubers.
- The seeds must be cooked using a special technique and soften slowly in water. The cooked, mature seeds have a strong flavor which is disliked by some. However, they do not have potential for the making of curds and tofu as with soybeans. The seeds have some likely metabolic (digestive) inhibitors that have not been adequately investigated.

Introducing a new crop into an area is usually a task better left to professionals associated with a research station that has the money, time, skills, and discipline for such an undertaking. The extension workers' job is to provide the tested recommendations for the crops grown in an area.

Appendix I - Troubleshooting common crop problems

It takes a lot of practice and detective work to accurately troubleshoot crop problems. Some abnormalities like wilting or leaf yellowing can have numerous causes.

First, learn to distinguish normal from abnormal growth when you walk through a farmer's field. Keep a close watch for telltale trouble signs such as abnormal color, stunting, wilting, leaf spots, and signs of insect feeding. Make a thorough examination of affected plants, including the root system and the inside of the stem, unless the problem is obvious. Obtain detailed information from the farmer concerning all management practices that might have a bearing on the problem (i.e. fertilizer and pesticide applications, name of crop variety, etc.). Note whether the problem occurs uniformly over the field or in patches. This can provide valuable clues, since some problems like nematodes and poor drainage seldom affect the entire field.

Troubleshooting tools

- A pocketknife for digging up seeds or slicing plant stems to check for root and stem rots or insect borers.
- A shovel or trowel for examining plant roots or checking for soil insects or adequate moisture.
- A pocket magnifying glass to facilitate identification of insects and diseases.
- A reliable soil pH test kit for checking both topsoil and subsoil pH. Especially useful in areas of high soil acidity. Beware of cheap kits, especially those using litmus paper. The Hellige-Truog kit is one of the best and costs about \$15 U.S.

Troubleshooting Guide

CROP APPEARANCE	PROBABLE CAUSES
-----------------	-----------------

<p>POOR SEEDLING EMERGENCE (Carefully dig up a section of row and look for the seeds)</p>	<p>Low-germination seed Planting too deep or too shallow Soil crusting or overly cloddy soil Lack of moisture Clogged planter Seeds washed out by heavy rain Fertilizer burn Pre-emergence damping-off disease Birds, rodents Seed-eating insects (wireworms, seed corn maggots, seed corn beetle)</p>
<p>WILTING(Pull up a few plants carefully using a shovel or trowel and examine the roots. Check stem for borers or rotted or discolored tissue.)</p>	<p>Actual lack of moisture due to drought or poor irrigation management (watering too lightly or too infrequently) Diseases (bacterial or fungal wilts, certain types of rot and stem rots) Very high temperatures, especially if combined with dry, windy conditions Root pruning by hoe or cultivator Nematodes (especially if confined to patches and when plants wilt despite having sufficient water) Stem breakage or kinking</p>
<p>LEAF ROLLING OR CURLING</p>	<p>Lack of moisture (maize, sorghum, millet) Virus Sucking insects feeding on stem or leaves Boron, calcium deficiency (beans only) Verticillium wilt (peanuts)</p>
<p>LEAF CRINKLING, PUCKERING LEAF "BURNING" OR BROWNING</p>	<p>Aphids, leafhoppers feeding on leaves or stems Drought Excessive heat Fertilizer burn Insecticide overdose Dipterex, Azodrin (Nuvacron), or methyl parathion injury on sorghum Herbicide damage Nutrient deficiency Aluminum, iron, or manganese toxicity due to excessive acidity (below pH 5.5) Salinity or sodium problems (confined largely to low rainfall areas, especially if irrigated) Boron toxicity from irrigation water (low rainfall areas) of improper placement of fertilizer boron</p>
<p>LEGGY, SPINDLY PLANTS HOLES IN LEAVES</p>	<p>Lack of sunlight caused by overcrowding or long periods of heavy cloudiness Caterpillars Beetles Earwigs Crickets Snails, slugs, especially on beans (check for slime trails) Breakdown of dead tissue due to fungal or bacterial leaf spots</p>
<p>SPOTS ON LEAVES</p>	<p>Fungal or bacterial leaf spots Virus Sucking insects Spilling of fertilizer on leaves Herbicide spray drift, especially paraquat (Gramoxone) Sunscald (beans)</p>
<p>LEAF MALFORMATION WITH STEM CURVING & TWISTING (Broadleaf plants only) LEAF MOTTLING, LEAF MALFORMATION, PLANT</p>	<p>2,4-D type herbicide damage due to spray drift or a contaminated sprayer (broadleaf crops only) Virus</p>

MALFORMATION LEAF STRIPING	Nutrient deficiency Virus Genetic
YELLOWING, STUNTING	Nutrient deficiency Nematodes Low pH (excessive acidity) Root rot, stem rot
OVERNIGHT DEFOLIATION OF PLANTS	Leaf cutter ants, grazing animals
PLANTS CUT OFF AT OR NEAR GROUND LEVEL TWISTING TUNNELS IN LEAVES YOUNG SEEDLINGS COLLAPSE NEAR GROUND LEVEL AND DIE POOR GROWTH, LACK OF VIGOR	Cutworms Mole Crickets Leaf miners Fungal seedling blights Heat girdling of stem (beans) Too dry or too wet Too hot or too cold Insects, diseases Weeds Unadapted variety Low pH Salinity-alkalinity problems Overcrowding Shallow soil Soil compaction, hardpan Poor drainage Nutrient deficiency Faulty fertilizer practices Nematodes Excessive cloudiness Herbicide carryover Overall poor management Damaged seed (beans)
LODGING OR STALK BREAKAGE (Maize, Sorghum, Millet)	Overcrowding Stalk rots Rootworms High wind K deficiency
POOR NODULATION ON PEANUTS, COWPEAS, SOYBEANS; OTHER LEGUMES THAT ARE EFFICIENT N FIXERS (Carefully dig up the root system and check for nodulation; clusters of fleshy nodules, especially on the taproot, and with reddish interiors are signs of good nodulation. Don't confuse nodules with nematode galls!)	Soil lacks the correct type of <u>Rhizobia</u> -seed inoculation is needed Improper inoculation: wrong strain, inoculant too old or improperly stored Exposure of inoculated seed to excessive sunlight or contact with fertilizer or certain seed treatment fungicides Excessive acidity (soybeans are especially sensitive to soil pH's below 6.0) Molybdenum deficiency Plants are too young (it takes 2-3 weeks after plant emergence for the nodules to become visible)

Appendix J - Guidelines for using pesticides

Pesticides are poisons and are used to kill particular plants and animals that reduce the productivity of a farmer's crop. Fortunately, however, many pesticides have unwanted side effects and may be hazardous to non-pest plants and animals, including man.

Pesticide toxicity to animals may be acute, i.e., having effects resulting in illness or death, or it may be chronic, i.e., having effects that may not be apparent for many years. Chronic toxicity may take the following forms:

oncogenicity - cancer-causing
teratogenicity - causing deformities in offspring
mutagenicity - causing genetic mutations
reproductive effects effecting an individual's capacity to bear young

It is important that the farmer and extension worker be aware of the level of toxicity of the chemicals with which they are working and the following table lists the relative acute toxicity of some commonly used pesticides. The toxicity classes presented are based upon oral and dermal acute toxicity to rats.¹

¹. Label requirements established by the U.S. Environmental Protection Agency (40 CFR & 162.10)

class 1 = most dangerous; requiring a label reading "danger"
class 2 = less dangerous; requiring a label reading "warning"
class 3 = less dangerous; requiring a label reading "caution"

Please note that the toxicity classes only refer to acute toxic effects and the chemical may be a Class 3, least dangerous, and still have serious potential long-term toxicity.

The acute toxicity is rated accordingly to the dose of pesticide that is lethal to 50 percent of the test animals that ingest it (oral LD₅₀) or absorbed through their skin (dermal LD₅₀). The LD₅₀ of a pesticide is measured in milligrams of pure chemical per kilograms of test animal body weight (mg/kg). The lower the LD₅₀ the less chemical required to kill 50 percent of the test animals and thus, the higher is the pesticide's toxicity. There are several important considerations in using the LD₅₀ ratings.

1. The LD₅₀ ratings are based on the amounts of 100 percent strength from one percent up to 95 percent. After dilution with water for spraying, actual strength may only be about 0.1-0.2 percent. As a general rule a pesticide which is highly toxic as a concentrate (Class 1) will still be dangerous when diluted to the concentration at which it is useful.
2. The LD₅₀ ratings give little information on the cumulative effect of repeated exposure.
3. If spilled on the skin, liquid insecticides are more readily absorbed than wettable powders or dusts.
4. Note that some insecticides like TEPP and Phosdrin are about as toxic dermally as they are orally.
5. Even Class 3 (least dangerous) insecticides like Malathion can cause severe poisoning if enough is ingested or spilled on the skin, especially in the concentrated form.

Pesticides include insecticides, fungicides, herbicides, nematocides and rodenticides. In general the herbicides and fungicides are not in the highly toxic categories (1 and 2) whereas a fair number of the insecticides and nematocides are very dangerous to use.

Table J-1 gives a partial listing of insecticides, their dermal and oral LD_{50s} and the chemical group to which each insecticide belongs as follows:

CH = chlorinated hydrocarbon,
OP = organic phosphate,
C = carbamate,
M = miscellaneous

The antidote for poisoning varies with the chemical group. Aside from this difference, it's hard to make meaningful distinctions between these chemical groups. For example, Aldrin, DDT, Endrin, Heptachlor, Lindane, and Kelthane (dicofol) have long residual lives and are all CH's. However, in terms of their immediate toxicity, they vary greatly - DDT is a Class 4 (least dangerous), while Endrin is a Class 1 (most

dangerous). Other CH's like Methoxychlor have relatively short residual lives. The OP's and C's break down fairly quickly, but, also vary greatly in toxicity.

Insecticide Names: Note that each insecticide may be marketed under several different trade names. Many extension bulletins refer to insecticides by their non-commercial chemical names (i.e. Sevin is a trade name for carbaryl). This can create much confusion in indentifying insecticides.

The following pesticides have been suspended, canceled or withdrawn United States and their use should not be encouraged in international agriculture projects:

DDT	Mirex	DBCP
Aldrin	Chlordane	2,4,5-T
Dieldrin	Heptachlor BHC	(benzene hexochloride)
Endrin	TOK	Amitroz
	Kepone	Pirimicosb gardona dimethoate(dusts only) galecron*

*Only can be applied under specialized handling conditions on non-food (cathon) crops where mixer/loads exposure can be carefully controlled.

Table J-1 Toxicity of Selected Insecticides

Category I				
Common Name	Other Trade or Chemical Names	LD₅₀ Oral	Rating Dermal	Chemical Group
Dasanit 6	Terracur, fensulfthion	2-10	3-30	OP
Disyston 6	Disulfoton, Fruminal, oxydisulfoton	7	15	OP
Dyfonate 6	Fonofos	8	25	OP
Endrin 2,5,6	Hexadrin	1	18	CH
Parathion 6	Ethyl parathion, Bladan, Niran, E-605, Polidol E-605, Phoskil, Orthophos, Ekatox, Parathene, Panthion, Thiopos, Alkron	13	21	OP
Phosdrin 5	meviphos, Phosphene, Menite	6	5	OP
Systox 6	demeton, Solvirex, Systemox, Demox	6	14	OP
Telodrin	isobenzan	5-30	5-30	CH
TEPP 6	Tetron, Vapotone, Kilmite 40	1	2	OP
Thimet 6	phorate, Rampart	2	6	OP
Temik 6	aldicarb	1	below 5	C
Aldrin 2,5	Aldrite, Aldrosol, Drinox, Seedrin, Octalene	39	98	CH
Azodrin 6	Nuvacron, Monocron, monocrotophos	17	126	OP
Bidrin 6	Ekafos, Carbicron	21	43	OP
Birlane 6	chlorfenvinphos, Supona, Sapecron	10-155	108	OP
Dieldrin 2,5	Alvit, Octalox, Dieldrite	46	90	CH
Furadan 4	carbofuran, Curaterr (See below for granules)	11	10,000	C
Gusathion 6	Guthion, Carfene, azinphosmethyl	12	220	OP
Methyl Parathion 6	Folidol M, Parathion M, Nitrox, Metron, Parapest, Dalf, Partron, Phospherno	14	67	OP
Lannate 6	Methomyl, Nudrin	17-24	1000	C
Monitor 6	Tamaron, methamidophos	21	118	OP
Mocap 6	Jolt, Prophos, ethoprop	61	26	OP
Thiodan	endosulfan, Cyclofan, Malix, Thimul, Thiodex	43	130	CH

Trithion	carbophenothion, Carrathion	30	54	OP
Nemacur 6	phenamiphos, fenamiphos	8	72	
Category II				
BHC 2,5	benzene hexachloride, Hexachlor, Benzahex, Benzel, Soprocide, Dol, Dolmix, Hazafor, HCH	600	---	CH
Bux	Bufenkarb, metalkamate	87	400	C
Chlordane	Chlorkill, Orthochlor, Belt, Aspon	335	840	CH
Ciodrin	crotoxyphos	125	385	OP
Diazinon	Basudin, Spectracide, Diazol, Gardentox, Sarolex	180	900	OP
Dibrom	naled, Bromex	250	800	OP
Dimethoate	Cygon, Rogor, Perfecthion, Roxion, De-Feud	215	400	OP
Dursban	chlorpyrifos, Lorsban	97-276	---	OP
Dipterex	Dylox, Klorfon, Danex, Trichlorfon, Neguvon, Anthon, Bovinox, Proxol, Tugon, Trinex	180	2000	OP
Folimat	methoate	50	700	OP
Folithion	Nuval, Agrothion, fenitrothion	500	1300	OP
Hostathion	triazaphos	80	1100	OP
Heptachlor 2,5	Drinox H-34, Heptamul	100	195	CH
Lebaycid	Fenthion	200	1300	OP
Lindane 2	Gamma BHC, Gammexane, Isotox, OKO, Benesan, Lindagam, Lintox, Novigam, Silvanol	88	1000	CH
Metasystox	oxydemetonhyl	47	173	OP
Mirex	dechlorane	300	800	CH
Toxaphene 3,7	Motox, Strobane T, Toxakil, Magnum 44	90	1075	CH
Unden	Baygon, Suncide, Senoran, Blattanax, PHC, porpoxur	100	1000	C
Vapona	DDVP, dichlorvos, Nuvah, Phosvit	90	107	OP
Category III				
DDT 2,5	Anofex, Genitox, Gesarol, Neocid, etc.	113	2510	CH
Galecron	chlordimeform, Fundal	127-372	3000	OP
Gardona 5	Appex, Rabon	4000	5000	OP
Kelthane 3	dicofol, Acarin, Mitigan	1100	1230	CH
Malathion	Cythion, Unithion, Emmatos, Fyfanon, Malaspray, Malamar, Zithiol	1375	4444	OP
Methoxychlor	Marlate	5000	6000	OP
Morestan	Forestan	1800	2000+	
Orthene	Acephate, Ortran	866	---	OP
Sevin	carbaryl, Vetox, Ravyon, Tricarnam	850	4000	C
Tedion	Tetradifon	14,700	10,000	CH
Volaton	phoxim, Valexon	1845	1000+	OP
Actellic	pirimiphos-methyl, Blex, Silosan	2080	2000+	OP

2. Long residue life (3-10 years).
3. Moderately long residue life (1-3 years).
4. High oral, low dermal (skin) toxicity.
5. Now banned or withdrawn from use in the U.S.
6. A restricted pesticide pesticide in the in the U.S. based upon its acute hazard to humans.
7. Chemicals now under EPA's Rebuttable Presumption against Registration (RPAR) process.

The following pesticides have been restricted for use in the United States, based on human hazard, and their use should not be encouraged in international small farmers' agricultural projects:

methyl parathion	methamidophos
ethyl parathion	methomyl (lannote) tamaron (monitor)
parathion	carbofubon (except granular formulations) dyfonate trithion

The following pesticides are being investigated by the U.S. Environmental Protection Agency under the Rebuttable Presumption Against Registration (RPAR) Program. These pesticides have possible risks in the following five areas, but the risks have not been proven and they are therefore still permitted for use:

1. Acute toxicity;
2. Chronic toxicity including oncogenic and mutagenic effects;
3. Other chronic effects;
4. Effects on wildlife; and
5. Lack of emergency treatment.

Pesticides presently under RPAR review include the following:

Beronyl	EBDC's, including Maneb, mancozeb, metiram, nodam, zireb, amobam
Cadmium	Ethylene dibromide
Captan	Ethylene oxide
Diallate	Inosyohk Arsenicals
	Lindane
	Maleic Hydrozide
	Sulfate
	Toxaphene
	Trifnralin

General Information on Common Insecticides

I Bacillus Thuringiensis

A biological insecticide made from a natural bacteria that kills only certain types of caterpillars; most effective against cabbage loopers but also against hornworms (Protoparce) and earworms (Heliiothis). Non-toxic to humans and animals. Insects don't die immediately but stop feeding within a few hours - it may take a few days for them to die. Apply before the caterpillars are large for best results. Needs no sticker-spreader for most formulations. Compatible with most other pesticides. Don't store the diluted spray for more than 12 hours. Dosage varies widely with the particular formulation.

II Diazinon (Basudin, Diazol, etc.)

Fairly broad-spectrum including control of many soil insects but not as effective on beetles (except for the Mexican bean beetle). Highly toxic to bees.

Aboveground insect control: 4cc/ liter of Diazinon 25 percent EC or Basudin 40 percent WP.

Dimethoate (Perfekthion^R Cygon^R Rogor^R etc.)

A systemic insecticide of moderate toxicity to humans (Class 2). Specifically for sucking insects (aphids, leafhoppers, thrips, stinkbugs, mites, etc.) and leaf miners. Should provide control for 10-14 days. Don't apply within 14-21 days of harvest. Highly toxic to bees with a one- to two-day residual effect.

General dosages for the three most common formulations (all emulsifiable concentrates are given below):

Formulation of dimethoate	Dosage-cc/100 liters
200 grams active ingred./liter	100-200
400 grams a.i./liter	50-100
500 grams a.i./liter	50-75

Dipterex (trichlorfon, Dylox^R, Dane^{xR}, Klorfon^R etc.)

Provides fairly broad spectrum insect control but not as effective on aphids, mites and thrips. Dipterex causes severe injury when applied to sorghum. Low to high toxicity for humans.

General above-ground insect control: 125-250 cc (100-200 grams) of Dipterex per 100 liters of water or 5-10 cc .

Armyworms or earworms feeding in the leaf whorl or maize: Dipterex 2.5 percent granules give longer control than sprays; apply a pinch in each whorl which works out to about 10-15 kg/ha (lbs./acre) of granules. 100 cc of the granules weigh about 60 g.

Furadan (Carbofuran)

A systemic insecticidemade available in 3 granular formulations (3 percent, 5 percent, 10 percent) and as a wettable powder. The wettable powder formulation is considered too toxic for normal use, however; the pure strength chemical has an extremely high oral but very low dermal toxicity. Furadan granules are usually applied to the soil either in the seed furrow or in a band centered over the crop row; furadan kills soil nematodes and soil insects but is also absorbed by the roots and translocated throughout the plant where it controls sucking insects, stem borers, and leaf feeding beetles and caterpillars for up to 30-40 days. Band treatments are recommended for root feeding soil insects, while seed furrow applications can be used for foliar insects. Furadan can also be band applied during the growing season if it is cultivated into the soil or can be applied to the leaf whorl of maize. May cause minor foliar injury to peanuts; do not place in contact with sorghum or bean seed.

Kelthane (dicofol, Acarin, Mitigan, Carbax)

Kills mites only; not harmful to beneficial insects. Gives good initial control of mites and has good residual activity against them; non-systemic. Spray undersides of leaves. Don't feed crop residues to dairy or slaughter anitreatment is effective approximately four months.

Sevin (carbaryl, Vetox, Ravyon, etc.)

Broad-spectrum insect control except for aphids and mites. Very low toxicity for humans (Class 3). Very toxic to bees with a 7-12 day residual effect.

General dosage for Sevin: Use the 50 percent WP at 8-16 cc per/1. Use 80 percent WP at 5-10 cc/1 or 1.252.5 tablespoons/gallon. Can be applied right up to harvest time on the reference crops.

Household dosages: For cockroaches and ants, use as a 2.5 percent strength spray (active ingredient basis); this equals about 100 cc of Sevin 80 WP per liter of water; don't use more than twice a week.

Ticks, lice, fleas, horn flies on beef cattle, horses, swine: Use 20 cc Sevin 80 percent WP per liter of water. Don't apply within five days of slaughter.

Mites, lice, fleas on poultry: Use at same rate as for beef cattle and apply about 4 liters per 100 birds; don't apply within seven days of slaughter.

Volaton (Valexon, phoxim)

A less toxic and persistent replacement for Aldrin for soil insect control. Low toxicity for humans. Also available as a liquid formulation for leaf insects.

General dosage for Volaton: Use the 2.5 percent granules at 60 kg/ha for furrow application and 120 kg/ha for broadcast application. Work into the top 5-7.5 cm of soil.

Fungicides: Except for mercury based fungicides used for seed treatment like Agallol, Semesan, and Ceresan, fungicides pose little hazard to health. Their oral toxicity is comparatively low, and there is little danger of dermal absorption. Some may cause allergies in sensitive people through skin contact and can be eye irritants as well. Low toxicity (Class 3).

General dosage: Use the 35 percent WP formulation at four to five cc per liter of water. Use the 18.5 percent EC at 1.5cc per liter of water.

Lebaycid (Fenthion, Baytex, Baycid)

A relatively low toxicity (Class 2) organic phosphate for chewing and sucking insects, including mites. Don't spray plants when temperatures exceed 32°C. Very toxic to bees with two to three days' residual activity.

General dosage for Lebaycid: Use Lebaycid 40 percent WP at 1.5-2 g per liter of water; use Lebaycid 50 percent EC at 1-1.5 cc/liter of water.

Malathion (Cythion, Unithion, Mala spray)

A broad-spectrum insecticide of low human toxicity (Class 3). Not as effective on armyworms, earworms, and flea beetles. Its residual activity is decreased if mixed with water above pH 8.0.

Can be mixed with other pesticides except Bordeaux and lime sulfur. Liquid formulations are moderately toxic to bees with less than two hours' residual effect; wettable powder formulations are highly toxic but have less than one day's residual effect on bees.

General dosage for Malathion: Four to five cc of Malathion 50 percent or 57 percent EC per liter of water. Use Malathion 25 percent WP at 12 cc/liter.

Using Malathion for Control of Stored Grain Insects

Grain which is to be held in storage should be protected from stored grain insects. An approved grain protectant applied to the grain at time of storage will help prevent an early infestation. Premium grade Malathion is the only protectant available. Malathion can be applied as a dust or spray at the following rates:

1. One percent dust on wheat flour at the rate of 60 lbs. per 1000 bushels of grain.
2. One pint of 57 percent (five pounds/gallon) EC in three to five gallons of water per 1000 bushels of grain.

Table J-2: Some insecticide recommendations for specific insects attacking the reference crops

1. These rates are based on the latest information (1978-80) from the U.S. Dept. of Agric., North Carolina State University, Clemson University (South Carolina), and CIAT.

Crop and pest maize	Insecticide	Amount of active ingredient needed kg/ha	Remarks and precautions
Cutworms	carbaryl	1.7-2.25	Recipes for cutworm baits are given.
	trichlorfon	0.9-1.1	Direct spray at base of plants; use trichlorfon on soils high in organic matter.

	chlorpyrifos	1.1-2.25	Baits will give better control. Use higher rates of chlorpyrifos for heavy infestations; don't apply chlorpyrifos within 50 days of harvest. Granules should be applied in an 18 cm wide band over the row at planting.
Rootworms (Diabrotica spp.)	Diazinon	1.1	Use Diazinon as a post-emergence basal spray treatment applied in a band over the row when symptoms appear.
	carbofuran	0.85-1.1	Apply Furadan granules in an 18 cm wide band centered over the row at planting or in the seed furrow.
Wireworms	carbofuran	1.1-2.25	Apply in seed furrow or in an 18 cm wide band over the row at planting; may not be effective in dry weather.
	Diazinon	2.25	Broadcast over entire soil surface and work into the top 10 cm 1-2 weeks before planting
Seed corn beetles, seed corn maggots, attacking seeds	Diazinon wireworms Lindane may also be used (see label for dosage)	mix dust or WP seed at the rate of 15 grams active ingredient per 10 kg of seed.	Handle treated seed with rubber gloves. Other products like Lindane can be used.
White grubs (Phyllophaga)	see wireworms	see wireworms	Don't use more than 1.1 kg/ha active ingredient Furadan if white grubs are the only problem.
Aphids, maize leaf (Rhopalosiphum)	Malathion	0.9-1.2	
Caterpillars feeding in the leaf whorl (Spodoptera, Heliothis, etc.)	Carbaryl	1.7-2.25	Direct spray into whorl; use lower rate on young maize.
	Malathion	1.4	Direct spray into whorl.
	trichlorfon	1.12	Direct spray into whorl or use Dipterex 2.5% granules at 10-15 kg/ha (about a pinch per whorl).
Flea Beetles	carbaryl	1.1	
	Diazinon	0.55	
Maize rootworm beetles (Diabrotica spp.)	carbaryl	1.1	Apply when there are 5 or more beetles feeding on the silks of each ear. Direct spray at the silks.
	Diazinon	1.1	
	Malathion	1.1	
Stem borers (Diatraea, Zeadiatraea, Busseola, Sesamia Chilo, Eldana)	Various non-systemics like carbaryl, Dipterex, Furadan.	See caterpillars	Most non-systemics will control stemborers if applied between hatching and stem entry; timing is critical; spray the leaf whorl. Furadan granules can also be used in the whorl or at planting; check local recommendations.
Lesser corn-stalk borer (Elasmopalpus lignosellus)	carbaryl trichlorfon	Use general dosage rates given in previous section.	Spray base of plants so that both stalk base and nearby soil are covered.
SORGHUM Aphids	Malathion	0.55-0.9	Do not use Dipterex or methyl parathion since they injure sorghum.

	dimethoate	0.25-0.37	
	Diazinon	0.28	
Earworms or armyworms feeding on the heads	carbaryl	1.7-2.25	Begin application when there is one medium to large caterpillar per head. Don't apply within 3 weeks of harvest.
Sorghum midge (Contarinia sorghicola)	carbaryl	1.4-1.8	Wait until 30-50% of heads have begun to bloom; begin spraying if two or more adult midges are found per head; timing is critical; repeat in 3-5 days where adults still exceed two per head.
	Diazinon	0.28	
Sorghum shoot fly (Atherigona)	See remarks	--	Seek local recommendations; Furadan may be used at planting but should not touch the seed.
MILLET Refer to sorghum and maize			
PEANUTS Rootworms (Diabrotica)	Diazinon	2.25-3.3	Apply in a band 40-50 cm wide centered over the row just prior to pegging and work into top 5-7.5 cm of soil.
White grubs or wireworms	Diazinon	2.25	Broadcast before planting and work into the top 7.5-10 cm of soil.
Thrips, leaf-hoppers, aphids wireworms, at planting treatment	carbofuran	1.1	Apply in the seed furrow at planting; reduce dosage by 25% on sandy soils, especially where runner varieties are used. Furadan is highly toxic orally.
Lesser corn-stalk borer (Elasmopalpus lignosellus)	Diazinon granules	2.25	Apply the granules in a band 40-45 cm wide over the row; Don't apply unless damaged plants exceed 10% before blooming or 15% after; don't use plants for forage within 7 days or for hay within 21 days.
Caterpillars on leaves	carbaryl	1.4-1.8	Peanuts are quite tolerant of leaf loss; don't apply unless there are 12 or more caterpillars per meter of row length; apply while they are still small. Don't feed Toxaphene treated plants to dairy animals or to those being finished for slaughter.
Leafhoppers	carbaryl	1.1-1.4	May be applied up until harvest.
	Methoxychlor	1.1	Don't feed Methoxychlor treated plants for 10 days.
Thrips	carbaryl	1.1-1.7	Can be applied up to harvest
	Malathion	0.9-1.1	Don't feed plants for 30 days.
		1.7-2.25	Don't feed plants to dairy animals or those being finished for slaughter.
Mites	Sulfur dust	7	Apply to underside of leaves once a week; also controls leafspot disease (Cercospora).
Cutworms	Baits	25 kg of bait/ha	For bait recipes, refer to the start of unit IX, this section.
	trichlorfon	1.1	Spray base of plants and nearby soil.
White grubs, wireworms	carbofuran	0.9	Apply in an 18 cm wide band over the row or in the furrow but not in direct contact with the seed; Furadan has very high oral toxicity.
	Diazinon	3.3-4.5	Broadcast over entire soil surface and worked into top 10 cm before planting.
		1.7	Banded over the row and worked into the top 10 cm before planting.
Aphids	Diazinon	0.55-0.85	

	Malathion	1.4	
	naled	1.1	
Bean leaf beetle (Cerotoma) and Diabrotica beetles	carbaryl	1.1-1.25	Use the lower rates on the bean leaf beetle.
	Malathion	1.4	
	Methoxychlor	1.1-3.3	
	Diazinon	0.44	
Bean pod weevil (Apion godmani) (granular)	carbaryl	2.25	Apply 6 days after flower initiation and then one week later.
	Methoxychlor	1.7	
	endosulfan	0.55-1.1	
Earworms (Heliothis spp.)	carbaryl	1.7-2.25	
	Methoxychlor	1.1-3.3	
Leafhoppers	carbaryl	1.1-1.7	
	Malathion	1.1-2.0	
	Methoxychlor	1.1-3.3	
	naled	1.1	
	carbofuran	0.7-1.0	Apply under the seed but not in direct contact; carbofuran has a very high oral toxicity; control lasts 30-40 days.
Lesser corn-stalk borer (Elasmopalpus lignosellus)	Diazinon	1.1-2.25	Spray in a band 15 cm wide over the row to cover base of stems and nearby soil.
	trichlorfon	1.1	
Mexican bean beetle (Epilachna)	carbaryl	0.55-1.1	
	acephate	0.75	Don't apply acephate within 14 days of harvest.
	endosulfan	1.1	Don't apply within 3 days of harvest.
	Malathion	1.35	
	Diazinon	0.55-0.85	
	Methoxychlor	1.1-3.3	
Mites	Kelthane	0.55-0.66	Don't apply dicofol within 7 days of harvest.
	dimethoate	0.28-0.56	
Slugs, Snails	Metaldehyde, carbaryl or trichlorfon	25 kg of bait per hectare	
Stinkbugs (Nezara spp.)	carbaryl	2.25	
	naled	1.7	Don't apply within 4 days of harvest.
	endosulfan	1.1	Don't apply within 3 days of harvest.

Bee Poisoning Hazard of Pesticides

Most bee poisoning occurs when insecticides are applied during the crop's flowering period. Spray drift is another hazard. To avoid bee kill:

- Do not apply insecticides toxic to bees when crops are flowering. Insecticides applied as a dust are the most harmful to bees.
- Do not dump unused quantities of dusts or sprays where they might become a bee hazard. Bees will sometimes collect any type of fine dust when pollen is scarce.
- Use insecticides of relatively low toxicity and residual effect for bees.
- Plug up or cover the hive entrances the night before spraying and then reopen them once the residual effect is over.

None of the fungicides is toxic to bees. The same is true with most herbicides, although Gesaprim (AAtrex, Atrazine) and the 2,4-D herbicides are low to moderate in toxicity.

Here is a partial guide to the relative toxicity of various insecticides for bees. Note the differences in residual effect.

WHEN APPLIED AS A SPRAY		
Insecticide	Toxicity to Bees	Residual Effect
Aldrin	Very high	Several days
Diazinon	High	One day
Dipterex	Low to High	2-5 hours
Lebaycid	Very high	2-3 days
Kelthane (dicofol)	Low	
Methyl parathion	High	Less than one day
Malathion	Moderate (liquid)	Less than 2 hours
	High (wetable powder)	Less than one day
Metasystox	Moderate	None
Dimethoate	Very High	1-2 days
Sevin	Moderate to High	7-12 days

Insecticide Safety Guidelines

1. Read and follow label instructions: If the label is vague, try and obtain a descriptive pamphlet. Not all insecticides can be applied to all crops. Inappropriate use can damage plants or result in undesirable residues. The label should state the minimum allowable interval between application and harvest.
2. Never buy insecticides that come in unlabeled bottles or bags; you may not be buying what you think. This is a serious problem in developing countries where small farmers often purchase insecticides in Coke bottles, etc.
3. When working with farmers, especially those using backpack sprayers instead of tractor sprayers, NEVER use or recommend those insecticides in toxicity Class 1. Their safe use requires extraordinary precautions and safety devices (gloves, special respirators, protective clothing, etc.). Whenever possible, avoid using Class 2 products. Unfortunately, extension pamphlets in many developing countries commonly recommend Class 1 and Class 2 products.
4. If using Class 2 insecticides, wear rubber gloves and a suitable respirator (good ones cost \$15-\$25), as well as long pants and a long-sleeve shirt; wear rubber boots if using a backpack sprayer. This clothing should be washed separately from other garments.

5. Do not handle plants within five days after treatment with a Class 1 insecticide or with Gusathion (Guthion). Do not handle plants within one day of using methyl parathion.
6. Class 1 and 2 insecticides are likely to be especially common in tobacco and cotton growing areas.
7. Do not smoke or eat while applying pesticides. Wash up well afterwards.
8. Repair all leaking hoses and connections before using a sprayer.
9. Prepare insecticide solutions in a well-ventilated place, preferably outdoors.
10. Never spray or dust on very windy days or against a breeze.
11. Notify beekeepers the day before spraying.
12. Insecticide poisoning hazards increase in hot weather.
13. Store insecticides out of reach of children and away from food and living quarters. Store them in their original labeled containers which should be tightly sealed.
14. Leftover spray mixtures should be poured into a hole dug in the ground well away from streams and wells.
15. Do not contaminate streams or other water sources with insecticides either during application or when cleaning equipment.
16. Make sure insecticide containers are never put to any other use. Burn sacks and plastic containers (don't breathe the smoke). Punch holes in metal ones and bury them.
17. Make sure that farmers are well aware of safety precautions. It is important that they understand that insecticides vary greatly in their toxicity.
18. Make sure that you and your client farmers are familiar with the symptoms of insecticide poisoning and the first aid procedures given below.

Symptoms of Insecticide Poisoning Organic Phosphates & Carbamates (Parathion, Malathion, Sevin, etc.)

Both groups affect mammals by inhibiting the body's production of the enzyme cholinesterase which regulates the involuntary nervous system (breathing, urinary and bowel control, and muscle movements).

<u>Initial Symptoms:</u>	Dizziness, headache, nausea, vomiting, tightness of the chest, excessive sweating. These are followed or accompanied by blurring of vision, diarrhea, watering of the eyes, excessive salivation, muscle twitching, and mental confusion. Tiny (pinpoint) pupils are another sign.
<u>Late Symptoms:</u>	Fluid in chest, convulsion, coma, loss of urinary or bowel control, loss of breathing.

Note: Repeated exposure to these organic phosphate and carbamate insecticides may increase susceptibility to poisoning by gradually lowering the body's cholinesterase level without producing symptoms. This is a temporary condition. Commercial insecticide applicators in the U.S. usually have their cholinesterase levels routinely monitored.

Symptoms of Chlorinated Hydrocarbon Poisoning (Aldrin, Endrin, Chlordane, Dieldrin, etc.)

Apprehension, dizziness, hyper-excitability, headache, fatigue, and convulsions. Oral ingestion may cause convulsions and tremors as the first symptoms.

First Aid Measures

1. In severe poisoning, breathing may stop, which makes mouth to mouth resuscitation the first priority. Use full CPR if the heart has stopped.
2. If the insecticide has been swallowed and the patient has not vomited, induce vomiting by giving a tablespoon of salt dissolved in half a glass of warm water. An emetic like Emesis (syrup of Ipecac) may be more effective, This should be followed by 30 grams (1 oz.) of activated charcoal* dissolved in water to help absorb the remaining insecticide from the intestines.

* Activated charcoal is made by heating charcoal to drive off its absorbed gasses.
3. Get the patient to a doctor as soon as possible. Bring along the insecticide label.
4. In the meantime, make the patient lie down and keep warm.
5. If excessive amounts are spilled on the skin (especially in the concentrate form), immediately remove clothing and bathe the skin in generous amounts of water and soap.
6. If the eyes have been contaminated by dusts or sprays, flush them immediately for at least five minutes with copious amounts of water. Insecticide absorption through the eyes is very rapid.

Antidotes

Whenever possible, antidotes should be given only under medical supervision. Too much or too little

Appendix K - Guidelines for applying herbicides with sprayers

The farmer should calibrate his/ her sprayer when a pesticide needs to be applied at an accurate dosage in order to avoid applying too much, which wastes money and might make the product ineffective. When working with small fields, farmers can usually use generalized recommendations given in cc/liter or tablespoons/gallon for insecticides and most fungicides. However, most herbicides require more accurate application, which means that sprayer calibration is usually needed.

The Principles Involved

When a pesticide recommendation is given in terms of kg/ha or lbs./ acre of active ingredient or actual product, the farm needs to know two things before he/she can apply the correct dosage:

- The amount of pesticide needed for his/her particular field.
- The amount of water needed to convey the pesticide to the plants or soil and give adequate coverage.

Once these are know, it is a simple matter of mixing the correct amounts of water and pesticide together, then spraying.

Calibration of backpack sprayers

NOTE: Only backpack sprayers with continous pumping action should be used when calibration is needed; compression type sprayers (the garden variety that needs to be set down to be pumped up) are not suitable because of their uneven pressure.

Step 1: Fill the sprayer with three to four liters of water and begin spraying the soil or crop using the same speed, coverage and pressure that will be used in applying the pesticide Measure the area covered by this amount water. Repeat this procedure several times to determine the average area sprayed. You can measure the area in terms of square feet or in terms of row length.

Step 2: Based on the area covered, you can calculate the amount of water needed to cover the field. For example, if three liters covered 60 square feet, and the field measures 20 x 30 feet, it would take 30 liters of water to cover the field.

Step 3: Determine the number of sprayer tankfuls of water needed to cover the field. For example, if the backpack sprayer holds 15 l, it will take two tankfuls to cover the field.

Step 4: Determine how much actual pesticide is needed for the field. If 4 kg of Sevin 50 percent wettable powder are needed per hectare and the farmer's field is 600 square feet, this would mean that 240 l of insecticide are required. Here's how we worked it out:

$$600 \text{ sq. m} / 10,000 \text{ sq. m} = X / 4000$$

$$X = 240$$

Step 5: Divide the amount of pesticide needed for the field by the number of sprayer tankfuls of water to determine how much pesticide is needed per tankful:

$$240 \text{ g Sevin 50\% WP} / 2 \text{ tankfuls} = 120 \text{ g Sevin/ tankful}$$

NOTE: A sprayer should be recalibrated each time it is used on a different crop, different of stage of crop growth or when another pesticide is used.

Alternate Method Using Row Length

When a pesticide is to be applied to a crop grown in rows, you can use row length instead of area as the basis for calibration. **PROBLEM:** Label instructions advise Juan to apply Malathion 50 percent strength liquid at the rate of 4 l/ha. His field measures 40 x 50 m and the bean rows are spaced 50 cm apart. His backpack sprayer hold 15 l, and he needs to know how much Malathion should be added to each tankful.

SOLUTION

1. Follow the same procedure as with Step 1 of the first method but measure the amount of row length covered by the 3-4 l instead of area. Suppose that Juan was able to cover 150 m of row length with 3 l.

2. Find out how many meters of row length his field has. Let's say the crop rows are running the long way (i.e. 50 m).

Number of rows x 50 m = field's total row length

Number of rows = 40 m / 0.8 m

(i.e. the field's width)

(80 cm)

50 rows x 50 m = 2500 m of row length in Juan's field

3. Find out how much water will be needed to cover the 2500 m of row length based on 3 l per each 150 m

$$150 \text{ m} / 2500 \text{ m} = 3 \text{ l} / X$$

$$150 X = 7500$$

$$X = 50 \text{ l of water needed to cover the field}$$

4. Find out how much Malathion 50 percent liquid will be needed for the field based on 4 l of the pesticide per hectare (10,000 sq. m). Since Juan's field measures 40 x 50m, its area is 2000 sq. m.

2000 sq. m / 10,000 sq. m = X 1 Malathion / 4 1 Malathion
X = 0.8 1 or 800 cc of Malathion needed

5. Find out how much Malathion is needed per sprayer tankful based on a capacity of 15 l.

50 l of water needed / 15 l tank capacity = 3.33 tankfuls needed
800 cc Malathion / 3.33 tankfuls = 240 cc of Malathion 50% liquid needed per sprayer tankful

Calibration of tractor sprayers

Things To Do Before Calibrating a Sprayer

- Rinse out the tank and refill it with clean water.
- Remove and clean all nozzles and screens. Use an old toothbrush.
- Start the sprayer and flush the hoses and boom with plenty of clean water.
- Replace screens and nozzles and make sure that they are of the correct spray pattern type and size.
- Check all connections for leaks.
- Adjust the pressure regulator to the correct pressure with the tractor engine running at field operating speed and with the nozzles running.
- Check the water output of each nozzle and replace any that are 15 percent above or below the average. Remember to:
 - Calibrate the sprayer using the same tractor speed and spray pressure that will be used to apply the pesticide.

When using water to calibrate, the spray rate of the water may differ somewhat from that of the actual pesticide-water solution due to differences in density and viscosity,

Calibration Method

1. Drive the tractor at field operating speed in the appropriate gear and measure the distance covered in terms of meters per minute (1 k.p.h. = 16.7 m per minute)
2. Operate the sprayer at the correct pressure with the tractor stationary, and measure the total output of the spray boom in liters per minute. To do this, use a jar to measure the individual output of several nozzles, calculate the average, and then multiply this by the number of nozzles to get the total output.
3. Measure the width of coverage of the spray boom in meters. Do this by multiplying the number of nozzles on the boom by their spacing in centimeters and then divide by 100 to obtain the total width in meters.
4. Use this formula to determine how many liters of water are needed per hectare:

Liter/hectare = 10,000 x output of spray boom in l/m / tractor speed in m/min x boom width in m

Once you know the volume of water needed per acre or hectare, you can determine how much pesticide needs to be added per tankful of water by using the same procedure as given for backpack sprayers.

Adjusting Sprayer Output

If the water output is too low or too high per hectare, change nozzle sizes or tractor speed. Changing the spraying pressure is relatively ineffective and may distort the spray pattern or cause excessive drift. Pressure must be increased four-fold in order to double output.

How to clean sprayers

In most cases, herbicide residues can be removed from sprayers by rinsing them out thoroughly with soap and water. However, the phenoxy herbicides (2,4-D, 2,4,5-T, MCPA, Tordon, etc.) cannot be removed with normal cleaning procedures, and contaminated sprayers may cause damage when used to apply pesticides to broadleaf crops. In fact, farmers should preferably use a separate sprayer for applying phenoxy herbicides, but reasonably good cleaning can be achieved as follows:

For backpack (knapsack sprayers): Fill the sprayer with water and add household ammonia at the rate of about 20 cc (ml) per liter of tank capacity. Spray part of the mixture out through the nozzle, and then let the sprayer sit for a day. Spray out the rest of the solution and then rinse with detergent and water. To test the sprayer, refill it with water and spray a few sensitive plants (tomatoes, beans, cotton, etc.). If injury signs are not noticed within a day or two, the sprayer is probably safe to use on broadleaf crops.

NOTE: Household ammonia or lye may damage the inner pressure cylinder if it is made of brass; in this case, use activated charcoal as below.

For tractor sprayers: Use two pounds of washing soda or soda ash (a 50-50 mix of washing soda and lye) 250 grams per 100 liters in the same way as for backpack sprayers. Activated charcoal, if available, will do a very quick job in just two to three minutes when used at 1 kg per 100 liters. Rinse out the sprayer with soap and water afterwards.

Symptoms of phenoxy herbicide damage: Only broadleaf plants are affected. In minor cases, the leaves show a slight downward curvature. If injury is severe, leaves and stems become very curved and twisted with considerable leaf distortion.

All washing should be done at a site away from drinking water sources for people or lives or water bodies that might be polluted by the washwater.

Appendix L - Important planting skill for extension workers

Most extension workers need five basic planting skills:

1. How to calibrate a planter.
2. How to calculate the probable final stand, given seed spacing and row width.
3. How to calculate the in-row seed spacing needed to provide a given population at various row widths.
4. How to determine the amount of seed needed for a given field size.
5. How to determine a farmer's actual plant population in the field Using a measuring tape.

Calculation of final stand

The calculation of the final stand is accomplished by the following formula:

$$\text{Plant population/ha} = [100,000,000 \text{ cm}^2/\text{ha}] / [\text{seed spacing in the row in cm} \times \text{row width in cm}]$$

For example, if the row width is 40 cm and seeds are spaced 10 cm apart. the final stand, assuming 100 percent germination and no plant mortality, would have:

$$100,000,000 / 40 \times 10 = 50,000 \text{ plants}$$

Likewise if the crop is planted in hills the calculation made is:

$$\text{Plant population/ha} = [100,000,000 \text{ (cm_/ha)} \times \text{number of seeds/hill}] / \text{row width (cm)} \times \text{hill spacing (cm)}$$

Thus planting in 50 cm width with 50 cm between hills and two seeds planted per hill yields:

$$100,000,000 \times 2 / 50 \times 50 = 80,000 \text{ plants/ha}$$

The same formula can be used to calculate the in-row seed spacing needed to provide a given population at various row widths. For example, if an optimal population of 100,000 plants/ha is desired, then:

$$100,000 \text{ plants/ha} = 100,000,000 / [\text{row seed width} \times \text{seed spacing (cm)}]$$

or:

$$\text{row width} \times \text{seed spacing} = 1000 \text{ cm}_\times$$

This spacing can be achieved using:

- 10 cm seed-spacing in 100 cm row width,
- 20 cm seed-spacing in 50 cm row width,
- 15 cm seed-spacing in approx. 70 cm rows, etc.

Note again that the calculation does not account for losses due to poor germination or plant mortality. You may want to plant 15 or 20 percent more than the amount you wish to harvest in order to account for these probable losses.

How to determine amount of seed needed to plant a given field size

You first need to know how many seeds of each crop are contained in a kilogram. The most accurate way of calculating this is to weigh out a 60 g sample of the seed and count it if you can find a reliable scale (i.e. at the post office or at a pharmacy). Multiplying the number by 10 will give the number of seeds per kilogram. Otherwise, you can use the table below as a rough guide:

Table 15 Number of Seeds per Kilogram

Maize	1760-2860
Sorghum	26,400-44,000
Peanuts	1100-1540
Beans	3000-3960
Cowpeas	3960-4040

To find the kilograms of seed needed per hectare, simply divide the number of seeds needed by the number of seeds/kg. Multiplying this times the size of the field in hectares will give the total amount of seed required.

How to determine a farmer's actual plant population

When troubleshooting a farmer's field, it is usually valuable to check out his plant population, since this has an important influence on yield potential and response to fertilizer. This can be easily done by counting the plants in 510 randomly selected strips of row each equal to 1/1000th of a hectare.

Step 1: First determine the field's average row width by measuring the distance across 10 complete rows and then dividing by 10. Do this at several random locations to get a representative average.

Step 2: Refer to the 1/1000th hectare row length chart for the proper random selection procedure.

Step 3: Select at random five to ten row strips of the appropriate length and count the number of plants in each and record it.

Step 4: Multiply the average number of plants in the row strips by 1000 to yield the plant population per hectare.

How to make a pre-harvest yield estimate

A pre-harvest yield estimate can be accurate to within 5 percent of the actual harvested yield if the correct procedure is used. When working with trial and demonstration plots, you should always take such a pre-harvest yield sample of both the test plot and the control plot. There is always the chance that the plots might be inadvertently harvested before the agreed-upon time without the yields being measured. Pre-harvest yield sampling is also a quick way of estimating crop yields in farmers' fields.

General Principles Of Yield Sampling

1. Samples should be collected at random for various portions of the field or plot. Do not purposely select samples from higher- or lower-producing areas within the plot or your estimate may be very inaccurate. A random sampling pattern should be determined before you enter the field so you will not be tempted to choose them by visual appearance.
2. Don't collect yield samples more than one week before the actual harvest.
3. When taking each sample, the area (or row length) to be harvested must be precisely measured. Do not estimate! Remember that any error in the sample area size will be magnified hundreds of times when converting the yield to a larger land unit basis.
4. You must adjust the sample weights to account for factors like excess moisture, damage, and foreign matter.

How to Take Samples and Estimate Yields

1. The Sampling Procedure

a. Number of samples: For plots less than 0.5 ha, take a minimum of five samples. For plots of over 0.5 ha, take between five and ten. If crop growth is not very uniform, take ten samples.

b. Size of each sample: Take each sample from the same sized area or same amount of row length. Individual sample size should be between 2.5 and 5.0 square meters. For row crops, the area of a sample is determined by multiplying row length by row width. (Harvesting three meters of corn row planted in rows one meter wide will give you a sampling area of three square meters.) Alternatively, use a section of row length equal to 1/1000th of a hectare. This will make later math calculations simpler, and the 1/1000 ha row length can be taken from the following table.

Row Width	1/1000th hectare Row Length
50 cm	20.00 m
60 cm	16.67 m
70 cm	14.28 m
75 cm	13.33 m
80 cm	12.50 m
90 cm	11.11 m
100 cm	10.00 m
110 cm	9.10 m

c. Taking a random sample: Decide on the sampling pattern before entering the field, and do not deviate from it. To randomize, the field can be divided up into sections and each section given a

number drawn from a hat. Or you can pick randomized starting points at the side of the field and then enter random distances from the starting point. A good system for row crops is to number the rows and select them at random, then select the distance into the row (field) at random. NOTE: Exclude three meters or four rows of perimeter from your sampling area along all four sides of the plot to ensure sampling from the heart of the plot.

2. Accuracy: Use a tape to measure each sampling area or row length. Use an accurate scale to record the total weight of the samples within one plot.

3. Handling the Samples: The samples should be harvested and processed according to local prevailing methods. If drying is required before shelling or threshing, be sure the location is secure and free from rodents or birds.

4. Weighing the Sample: Use an accurate portable scale. You do not need to weigh individual samples separately, but only the fatal collective sample from the plot. If you cannot find a good portable scale, have the grain weighed in town.

5. Checking Grade: Take a random sample of the collective sample and have it checked for moisture content and any other graded qualities if necessary. (Refer to the storage section in Chapter 7 for how to determine grain moisture content.)

6. Yield Calculations:

Size of total sample area = No of samples _ size of individual sample areas

7. Correcting for Moisture: Yields are usually based on grain that is dry enough to store in shelled form (usually 13-14 percent moisture content). If you base your estimates on the weight of a high moisture sample, you should revise the yield downward using this simple formula (otherwise, dry the grain first).

Grain weight after drying = [% dry matter before drying / % dry matter after drying] x original grain weight

Example: Suppose you weigh a collective sample of "wet" grain and then estimate the plot yield to be equal to 3500 kg/ha. A moisture test shows the sample has 22 percent moisture; what is the actual yield based on 13 percent moisture?

22% moisture = 78% dry matter,

13% moisture = 87% dry matter

$78\% / 87\% \times 3500 \text{ kg/ha} = 3138 \text{ kg/ha}$ yield based on 13% moisture

A Yield Estimate Example

Suppose you are taking a yield estimate on a farmer's maize plot which is slightly less than 0.5 hectare. The rows are planted 90cm apart, and you decide to take six samples, each consisting of 1/1000th hectare of row length. The collective weight of the shelled, dried maize is 18 kg. What is the estimated yield on a per hectare basis?

Solution:

area of collected sample = 6/1000ths of a hectare = 60 sq. meters

$18 \text{ kg} \times [10000 \text{ sq.m (1 hectare)} / 60 \text{ sq. meters}] = 3000 \text{ kg/ha}$ estimated yield

Glossary

<u>Crop rotation:</u>	The repetitive growing of an orderly succession of crops on the same field.
<u>Field trial:</u>	An on-farm trial repeated simultaneously on a number of local farms to compare a new practice or "package" of practices with the present practice or practices. It is designed to obtain information, not as a demonstration.
<u>Fungicide:</u>	Any pesticide that kills or halts the development of fungi.
<u>Herbicide:</u>	Any pesticide that kills weeds.
<u>Hybrid:</u>	A type of improved crop variety produced by crossing two or more inbred lines of a crop.
<u>Legume:</u>	Any plant belonging to the <u>Leguminosae</u> Family whose members all produce their seeds in pods. Legumes can satisfy part or all of their nitrogen needs through a symbiotic relationship with <u>Rhizobia</u> bacteria that form nodules on the roots. Beans, cowpeas soybeans, mungbeans, lima beans, chickpeas, pigeonpeas, and peas are legumes.
<u>Monoculture:</u>	The repetitive growing of a single crop on the same field year after year.
<u>Multiple cropping:</u>	The growing of two or more different crops at the same time on the same field: also referred to as intercropping.
<u>Nematodes:</u>	Tiny, colorless, threadlike roundworms that live in the soil and parasitize plant roots.
<u>Nitrogen fixation:</u>	The beneficial process by which <u>Rhizobia</u> bacteria convert atmospheric nitrogen into a usable form for plants. <u>Rhizobia</u> bacteria are associated only with legumes.
<u>Phosphorus fixation:</u>	The process by which added fertilizer phosphorus becomes tied-up as insoluble compounds in the soil and unavailable to plants. Phosphorus fixation is a problem on all soils but is especially severe on highly weathered, acid, red tropical soils.
<u>Pulse:</u>	A legume crop whose mature dry seeds are suitable for human consumption; examples are beans, cowpeas, soybeans, chickpeas, and mungbeans.
<u>Result test:</u>	See field trial.
<u>Rhizobia:</u>	A type of bacteria associated with legumes and capable of nitrogen fixation.
<u>Soil texture:</u>	The relative amount of sand, silt, and clay in a given soil.
<u>Soil filth:</u>	The current physical condition of a soil in terms of its workability and ease of moisture absorption. A soil's filth can vary markedly with its texture, humus content, and current moisture content.
<u>Systemic insecticide:</u>	An insecticide that is absorbed into the plant sap and translocated (transported) throughout the plant.
<u>Threshing:</u>	The process of separating the seeds of cereal and pulse crops from the seedheads, cobs or pods.
<u>Tillering:</u>	The production of side-shoots by a crop during its growth; tillering is common in millet and sorghum.
<u>Transpiration:</u>	The loss of soil moisture by plant root absorption and passage into the air through the leaf pores.
<u>Winnowing:</u>	The process of separating chaff and other light trash from threshed grain using wind, fan-driven air or screens.

Bibliography

Disease Identification And Control

American Phytopathological Society. "A Compendium of Corn Diseases." American Phytopathological Society, 3340 Pilot Knob Rd., St. Paul, Minnesota 55121. Very complete and also includes control measures.

Clemson University Cooperative Extension Service. "Soybean Diseases Atlas." Clemson University Cooperative Extension Service, Clemson, South Carolina 29631. One copy free. Includes identification and control.

-----"Soybean Insects, Nematodes, and Diseases." Circular 504, Clemson University Cooperative Extension Service, Clemson, South Carolina 29631.

International Center for Tropical Agriculture in Colombia (CIAT). "Field Problems of Beans in Latin America." CIAT, Apartado Aereo 6713, Cali, Colombia. \$5.60 plus postage. Includes diseases, insects, and hunger signs along with control measures. Available in English and Spanish.

International Crops Research Institute (ICRISAT). "Sorghum and Pearl Millet Diseases Identification Handbook." Information Bulletin No. 2, ICRISAT, P.O. Patancheru 502 324, Andhra Pradesh, India. One free copy. Available in English, French, and Spanish. Handy pocket guide but gives little information on control methods.

International Maize and Wheat Improvement Center in Mexico (CIMMYT). "Maize Diseases: A Guide for Field Identification." Information Bulletin No. 11, CIMMYT, Apartado Postal 6-641, Mexico 6, D.F. One copy free. Available in English and Spanish. Handy pocket guide to identification but gives little information on control methods.

Texas Agricultural Extension Service. "Sorghum Diseases." Bulletin 1085, Texas Agricultural Extension Service, Texas A&M University, College Station, Texas 77843. Includes both identification and control.

United States Department of Agriculture. "Bean Diseases: How to Control Them." Agriculture Handbook No. 225, United States Department of Agriculture Agricultural Research Service. Available from the Superintendent of Documents, U.S. Government Printing Office, Washington, D.C. Not as complete as the CIAT bulletin.

Grain Storage And Drying

Baikaloff, A. "A Crop Drying Guide for the Queensland Peanut Grower." Peanut Marketing Board, Kingaroy, Queensland, Australia. \$2 U.S. plus postage. Covers low-temperature, forced-air drying of bulk and bagged peanuts using motor-driven fans.

Food and Agriculture Organization of the United Nations. Handling and Storage of Food Grains in Tropical and Subtropical Areas. Food and Agriculture Organization of the United Nations, Via delle Terme de Caracalla, 00100, Rome.

Lindblad, Carl. Programming and Training for Small Farm Grain Storage. PT&J Series. Available from Peace Corps/ICE, 806 Connecticut Ave., N.W., Washington, D.C. 20525.

Lindblad, Carl, and Laurel Druben. 1976. Small Farm Grain Storage. ACTION/PC Program and Training Journal Series No. 2. Peace Corps/ICE, 806 Connecticut Ave., N.W., Washington, D.C. 20525. Very comprehensive and includes design details for dryers and storage facilities.

Midwest Plan Service. Low Temperature and Solar Grain Drying Handbook. Midwest Plan Service, Iowa State University, Ames, Iowa 50011. \$3 plus overseas postage.

Ohio State University. "Corn Harvesting, Handling, Marketing in Ohio Bulletin 502, Cooperative Extension Service, Ohio State University, Columbus, Ohio 43210.

Purdue University Cooperative Extension Service. "Selecting a Grain Drying Method." Bulletin AE-67, Purdue University Cooperative Extension Service, Lafayette, Indiana 47907.

Hunger Signs In Crops

Aldrich and Leng. Modern Corn Production, 2nd ed. F&W Publishing Co. 22 E. 12th St., Cincinnati, Ohio

CIAT. Field Problems of Beans in Latin America. 1978. Series GE-19, CIAT, Apartado Aereo 6712, Cali, Colombia.

Sprague, H.W., ed. 1964. Hunger Signs in Crops, 4th ed. David McKay Co., New York.

Implements and Equipment

Watson, Peter. 1981. Animal Traction. Peace Corps/ICE. Covers the selection and caring of draft animals and the use of basic animal-drawn tillage and cultivation equipment.

Insect Identification And Control

CIAT. Field Problems of Beans in Latin America. CIAT. Apartado Aereo 6713, Cali, Colombia. \$6.50 plus postage.

Fichter, G. Insect Pests. Western Publishing Co., 1220 Mound Ave., Racine, Wisconsin 53404. \$2.95 plus postage. Excellent pictorial and descriptive pocket guide of worldwide usefulness.

Hill, D. Agricultural Pests of the Tropics. Cambridge University Press, London, 1975. A useful addition for a Peace Corps incountry ag library; well illustrated.

Pesticide Use

Division of Continuing Education. "North Carolina Agricultural Chemicals Manual" (revised yearly). Division of Continuing Education, P.O. Box 5125, Raleigh, NC 27650. Single copy price for 1981 is \$5.00 plus postage. Comprehensive guide to pesticide selection, safety and dosages.

Soil Management And Fertilizer Use

Peace Corps. 1981. Soils, Crops, and Fertilizer Use. Peace Corps/ICE, Reprint R8. A what, how and why guide to soil management, determining fertilizer needs, and using organic and chemical fertilizers appropriately under small farmer conditions.

Weed Identification And Control

Clemson University. "Weeds of the Southern U.S." Clemson University Cooperative Extension Service, Clemson, SC 29631. Contains pictures and descriptions of some 150 common weeds of the tropics and sub-tropics.

Winged Beans

National Academy of Sciences. "The Winged Bean a High Protein Crop for the Tropics." Available from that National Technical Information Service, Springfield, VA 22161. 45 pages. \$4.50. Single copies free.

United States Department of Agriculture. 1978. "Vegetables of the Hot-humid Tropics--Part I: The Winged Bean." United States Department of Agriculture Agricultural Research Service. Available from the Mayaguez Institute of Tropical Agriculture, Box 70, Mayaguez, Puerto Rico 00708. 22 pages. Questions some of the claims made for the crop.

University of Illinois. The Winged Bean Flyer. University of Illinois Department of Agronomy, Urbana, Illinois. A newsletter devoted to the winged bean.

References

For more specific information on crops contact the following international crop improvement associations:

The International Center for Tropical Agriculture in Colombia (CIAT): focuses on maize, beans, and casava (manioc). Address: Apartado Aereo 6713, Cali, Colombia.

The International Crops Research Institute for the Semi-arid Tropics in India (ICRISAT): focuses on millet, sorghum, peanuts, chickpeas, and pigeonpeas. Address: Patancheru P.O., Andhra Pradesh 502 324, INDIA

The International Institute for Tropical Agriculture, Nigeria focuses on maize, grain legumes (cowpeas, lima beans, soybeans), rice, root and tuber crops. Address: Oyo Road, PMB 5320, Ibadan, NIGERIA, West Africa. Also has a farming systems research program.

The International Maize and Wheat Improvement Center in Mexico (CIMMYT). Address: Londres 40, Apdo. Postal 6-641, MEXICO 6, D.F.

The International Potato Center, Peru (CIP). Address: Apdo. 5969, Lima, PERU, S.A.

The International Rice Research Institute, the Philippines (IRRI). Address: P.O. Box 583, Manila, PHILIPPINES.