



FEED ^{THE} FUTURE

The U.S. Government's Global Hunger & Food Security Initiative



A MANUAL FOR TRAINERS OF SMALL-SCALE BEEKEEPING DEVELOPMENT WORKERS

(JUNE 2015 REVISED EDITION)

PEACE CORPS PUBLICATION NO. T0029



USAID
FROM THE AMERICAN PEOPLE



Knowledge and Learning Unit

The Peace Corps Knowledge and Learning Unit (KLU), a department of the Office of Overseas Programming and Training Support (OPATS), makes the strategies and technologies developed by Peace Corps Volunteers, their co-workers, and their counterparts available to development organizations and workers who might find them useful. KLU works with Peace Corps technical and training specialists to identify and develop information to support Volunteers and overseas staff. KLU also produces and distributes training guides, curricula, lesson plans, project reports, manuals, and other material.

Peace Corps-generated materials are also developed in the field. Some materials are reprinted “as-is”; others provide a source of field-based information for the production of manuals or for research in particular program areas. Materials submitted to KLU become part of the Peace Corps’ larger contribution to development.

This publication was produced by the Peace Corps with funding from the U.S. Agency for International Development’s (USAID) Bureau of Food Security. It is distributed through KLU. For further information about KLU materials (periodicals, books, videos, etc.) and information services, or for additional copies of this manual, please contact KLU and refer to the KLU catalog number that appears on the publication:

Peace Corps

Overseas Programming and Training Support

Knowledge and Learning Unit

1111 20th Street, NW

Washington, DC 20526

Abridged Dewey Decimal Classification (DDC) Number: 638.1

Share Your Experience!

Add your experience to the Peace Corps library of resources. Send your materials to us so we can share them with other development workers. Your technical insights serve as the basis for a generation of KLU materials, reprints, and training materials. They also ensure that KLU is providing the most up-to-date and innovative problem-solving techniques and information available to you and your fellow development workers.

A Manual for Trainers of Small-scale Beekeeping Development Workers

The Peace Corps

Knowledge and Learning Unit

1983 (Revised June 2015)

Acknowledgement

A Manual for Trainers of Small-scale Beekeeping Development Workers replaces an earlier publication of the same name that was produced for the Peace Corps by CHP International in 1983. Some of the original authors included Curtis Gentry, Robert C. Rice, Michael Wilburn, and Charlotte Sommer. This revision was done in 2015 under contract with EnCompass, LLC, through Feed the Future funding from USAID. The Peace Corps review team included Agriculture Specialist Gordie Mengel and Expert Consultant Lee Lacy. The original manual was developed from material produced by Volunteers and staff members in Washington, D.C., and at Peace Corps posts throughout the world.

Table of Contents

Introduction.....	6
Session 1: Functional Biology of the Honey Bee.....	11
Session 2: Types of Bees and the Bee-Human Relationship.....	13
Session 3: Anaphylactic Shock.....	16
Session 4: Bee Space and Types of Hives.....	18
Handout 4A: Different Qualities of the Types of Beehives.....	20
Session 5: Observation Hive.....	21
Session 6: Constructing KTBHs & Preparing the Apiary Site.....	24
Session 7: Bee Colony Cycle.....	27
Handout 7A: The Essence of Beekeeping.....	29
Session 8: Assembling Protective Clothing.....	31
Session 9: Establishing Individual Nucs.....	34
Handout 9A: European vs. African Bees.....	37
Session 10: Bee Management Techniques.....	38
Session 11: Foraging.....	41
Session 12: Hive Design Criteria & Swarm Boxes.....	44
Session 13: Transferring Colonies.....	48
Session 14: Queen Rearing.....	51
Handout 14A: Queen Rearing- Beetsma Method.....	54
Handout 14B: Queen Rearing- Miller Method.....	55
Session 15: Swarming, Supersedure, and Absconding.....	59
Session 16: Constructing a Swarm Board and Swarms.....	62
Session 17: Extractors and Solar Wax Melters.....	65
Handout 17A: Making and Using a Solar Wax Melter.....	68
Session 18: Gender and Development- The Role of Men and Women in Beekeeping.....	71
Handout 18A: Strategies for Integrating Women in Development Projects.....	74
Session 19: Melliferous Plants.....	75
Session 20: Honey.....	77
Session 21: Other Hive Products.....	80
Session 22: Bee Fair.....	83
Handout 22A: Guidelines for Preparing for a Bee Fair.....	86
Session 23: Beeswax Field Trip.....	87
Session 24: Creamed Honey and Beeswax Products.....	89
Session 25: Bee Diseases and Pests.....	91
Session 26: Insecticides and Bees.....	93
Resources.....	96
Appendix A: Hive Plans.....	97
Appendix B: Equipment Plans.....	100

Introduction

Peace Corps Beekeeping Manuals

As part of the United States government's efforts to address food security in the developing world and specifically the United States Agency for International Development's Feed the Future initiative, the Peace Corps edited and revised a number of existing manuals that were originally designed for use by Volunteers in the late 1970s and early 1980s.

Given the need of Volunteers and staff to access information on a variety of topics related to food security, subject matter experts reviewed and updated these manuals and their accompanying references. The content around some topics has not changed much since the manuals were initially produced. References have been reviewed and updated where necessary and new websites identified for additional content.

The three manuals that Volunteers may want to access related to beekeeping include:

1. *Small-Scale Beekeeping* [M0017]
2. *Lesson Plans for Beekeeping* [R0032]
3. *A Manual for Trainers of Small-scale Beekeeping Development Workers* [T0029]

Content of the first manual listed supports the other two manuals and should be reviewed before the others.

Small-Scale Beekeeping [M0017] provides an overview of beekeeping and its possibilities as a tool for development. The manual focuses on "intermediate levels" of beekeeping that can be self-sustaining using only local resources.

Lesson Plans for Beekeeping [R0032] was originally written for Peace Corps Volunteers in the Philippines but quickly adapted by other countries. It includes detailed instructions on how to build beekeeping equipment that Volunteers can access locally.

A Manual for Trainers of Small-scale Beekeeping Development Workers [T0029] is useful for Volunteers and staff for training purposes. The content is adaptable to pre-service and in-service training events. It is also valuable to Volunteers interested in training community members. The training is designed to help participants develop the skills they will need to work and live as beekeeping extensionists.

Goal of this Training Manual

The emphasis of this training is on equipping future Volunteers, counterparts, and community members with the skills necessary to promote appropriate beekeeping development. This is a creative process that requires individuals to take an active role in identifying their own needs and finding appropriate and sustainable ways to meet them. The sessions outlined in this manual cover a range of skills needed to establish beekeeping projects.

The approach to training used in this manual is based on the principles of nonformal education and is designed to strike a balance between structured learning and independent discovery. By using the sessions, resources, and methods outlined here, participants will develop a working knowledge of beekeeping, as well as skills for applying that knowledge in a meaningful way.

How to Use the Manual

This manual contains session outlines on topics related to beekeeping. Some sessions are longer than others and may require establishing beehives and equipment needed to engage in beekeeping. Use it as a reference in developing a specific schedule that meets the needs of the particular training situation.

Sessions follow a consistent format that is briefly explained on the following page. Be certain to read sessions thoroughly in advance. There are often several purposes to each session; for example, the procedures may be designed to meet a beekeeping objective and at the same time, provide participants with practice in group problem-solving or communication skills.

The training program is designed to be responsive to a variety of training situations. Modification and adaptation of the materials is encouraged.

The use of the term “participant” includes counterparts and other community members who fully participate in the training.

Introduction

Session Format

Title

Total Time

The estimated time for teaching the session. This may vary depending on how the material is used and language barriers. Note that some sessions are broken into a series of activities during training.

Overview

A brief statement on how the session relates to the overall training program, the activities in the session and expected outcomes.

Objectives

Statements of what is expected of participants in order to successfully complete the training program.

Resources

- Printed materials needed for the session or useful for background information.
- Handouts follow some sessions. Copies of handouts should be made in advance for distribution to the participants during the session. Some handout are just intended as resources for the trainer.

Materials

Supplies and tools needed for the session.

Procedures

A series of steps to follow in order to meet the objectives of the session.

Trainer Note

Notes to further explain the activities of the session. This may include such things as alternatives, scheduling considerations, suggestions, and further directions to the trainer.

Participant-Led Sessions

The transfer of skills and information is a primary task of a Peace Corps Volunteer and counterparts. Several sessions provide them an opportunity to further develop communication skills by independently designing and delivering them. They will conduct a session and receive feedback from their peers on the effectiveness of the design and delivery. These participant-facilitated sessions encourage the individual to acquire and effectively present beekeeping information.

At the beginning of the training, post on newsprint the following list of participant-facilitated sessions and the dates they are to occur:

- Session 1: Functional Biology of the Honey Bee
- Session 2: Types of Bees and the Bee-Human Relationship
- Session 4: The Bee Space and Types of Hives
- Session 7: Bee Colony Cycle
- Session 11: Foraging
- Session 15: Swarming, Supersedure, and Absconding
- Session 16: Constructing a Swarm Board and Swarms
- Session 17: Extractors and Solar Wax Melters
- Session 19: Melliferous Plants
- Session 20: Honey
- Session 21: Other Hive Products
- Session 25: Bee Diseases and Pests
- Session 26: Insecticides and Bees



All participant-led sessions in this manual are indicated by the icon above.

For the participant-led sessions, make session plans available to the participants and counterparts to help them with their preparation. However, encourage them to be innovative in both their session design and delivery. Always be available as a resource to help participants in preparing their sessions.

Introduction to Session Evaluation

During the first participant-led session, explain the difference between session design and facilitation. Briefly discuss the importance of good training design and facilitation skills in the role of a Peace Corps Volunteer.

Explain the format of the evaluation process for session design and facilitation skills. Point out that there will be a series of participant-facilitated sessions during the training program.

Introduction

At the end of each of these sessions, 15 minutes will be set aside to evaluate the design of the session and the facilitation skills used by the participant. As these evaluations occur, an ongoing list of session design components and facilitation skills will be developed. These lists may be posted permanently in the classroom and will be referred to and amplified throughout the program.

Evaluation of Session Design

For each participant-led session, ask the participant who facilitated the session to evaluate its design, then ask the remaining group members for their evaluation. Have a participant begin a list, on newsprint, of the components of good session design. Guide the evaluation process with the following questions:

- What generalizations can be drawn regarding the design of this session?
- What was good about it?
- What are some points where it could be improved?
- How might this session be designed differently for working with different groups?

Evaluation of Facilitation Skills

Ask the participant who conducted the participant-led session to evaluate the facilitation of the session, then ask the remaining group members for their evaluation. Have a participant begin a list, on newsprint, of facilitation skills. Guide the evaluation process with the following questions:

- What did the facilitator do to help the session go smoothly?
- What behaviors of either the facilitator or participants were particularly effective in facilitating learning? Which were not so effective?
- Would these same behaviors be effective when working with host country farmers, or agency-level personnel?

Identifying Participant Facilitators

Ask participants to volunteer to facilitate the listed sessions and ask for a different participant to conduct the evaluation of each session. Suggest that the same participant may want to facilitate **Session 16. Swarming, Supersedure, and Absconding** and **Session 17. Constructing a Swarm Board and Swarms**. Suggest that **Session 20. Melliferous Plants** be done by a participant with an interest in botany.

List the names of the facilitators and evaluators on the newsprint and leave it posted in the classroom. Point out that less time should be needed for evaluation during each ensuing participant-facilitated session as the evaluation and feedback skills of the group improve.

Session 1: Functional Biology of the Honey Bee

Total Time

Approximately 2 hours



Overview

Good beekeeping requires that the beekeeper knows bees and their needs and how to meet the supply needs of a colony. The beekeeper who understands bee biology is better able to ensure that appropriate management techniques are carried out. This session provides participants with an understanding of the biology of honey bees and gives them the opportunity to observe the various life stages of bees.

Objectives

- Explain the role of each caste in the colony
- List the resource needs of the colony
- Explain the life cycle stages of honey bees

Resources

- <http://www.beesfordevelopment.org>
- *Small Scale Beekeeping* [M0017]
- *Lessons Learned from Beekeeping in the Philippines* [R0032]
- *The Hive and the Honey Bee*, by Dedant and Sons
- *The Bee Keeper's Handbook*, by D. Sammataro and A. Avitabile

Materials

Blackboard, chalk, samples of different castes of bees, observation hive with bees, nucleus with bees, schematic drawing of honey bee, hand lens, personal protective clothing, smoker, fuel, and matches

Session 1: Functional Biology of the Honey Bee

Procedures

Step 1: Anatomy of the Honey Bee (30 minutes)

Pass around samples of various honey bees and hand lenses. Point out and describe the basic features of the anatomy of the honey bee on a large schematic drawing while the participants examine the samples. Focus on those structures that are useful to bees in their role as pollen and nectar gatherers. Introduce terms using the language that the participants will use at their posts. Encourage discussion and answer questions.

Step 2: Castes and the Honey Bee Life Cycle (30 minutes)

Give a brief lecture on the castes and the honey bee life cycle. Describe the three castes found in honey bees. Emphasize the characteristics that distinguish one caste from another.

Explain the specific functional duties and relate those duties to the anatomical structures of each caste. Outline the life cycle of the queen, worker, and drone. Emphasize the role of nutrition in developing the queen and the different developmental times for each caste.

Step 3: Resource Needs of the Colony (30 minutes)

Question participants on the resource needs of a bee colony and list these. Point out that the specific resource needs of the colony change during the year and relate the availability of resources to hive management. Explain that the beekeeper can supply specific nutritional needs during certain periods to increase the productivity of the colony.

Step 4: Demonstration/Review (30 minutes)

Show a bee colony to demonstrate and review the topics discussed. Show a normal, healthy colony and stress the importance of differentiating a healthy colony from a diseased colony.

Provide the participants with an opportunity to distinguish between drones and workers and between eggs and young larvae.

Point out the royal jelly surrounding all larvae less than 2 days old. Also point out callow (inexperienced) adult bees or teneral.

Session 2: Types of Bees and the Bee-Human Relationship



Trainer Note

Peace Corps Volunteers and their counterparts should avoid importing bees. Bees should be developed and obtained locally. Volunteers and counterparts should follow the guidance of ministries and experienced local beekeepers in choosing bees.

Total Time

1 hour, 45 minutes

Overview

The type of bee, along with ecological and cultural factors, affects the bee-human relationship in an area. A good understanding of all these factors is necessary to decide upon an appropriate approach to beekeeping development. This session will prepare the participants to assess the beekeeping situation where they will be working and to adjust their skills to the area.

Objectives

- List types of bees used for honey production
- Identify features that distinguish wasps from bees
- List desirable traits in bees for beekeeping
- Compare and contrast African and European bees
- List ways that information on beekeeping with European bees or under temperate conditions needs to be modified to make it applicable to African bees or to tropical conditions
- Explain the impact of the African bee on beekeeping in Latin America (for the Inter-American region)
- Explain the bee-human relationship

Session 2: Types of Bees and the Bee-Human Relationship

Resources

- <http://www.beesfordevelopment.org>
- *Small Scale Beekeeping* [M0017]
- *Lessons Learned from Beekeeping in the Philippines* [R0032]
- *The Hive and the Honey Bee*, by Dadant and Sons
- *The Bee Keeper's Handbook*, by D. Sammataro and A. Avitabile

Materials

Blackboard, chalk, hand lens, preserved samples of African and European bees, world map, pictures and/or slides of various beekeeping situations, sugar water (2:1 water to sugar) in tray, insect net, and kill jar

Procedures

Trainer Note

A bait station should be set up a day before this session so there will be enough time to attract a variety of sugar-feeding insects. If there is a strong nectar flow, it may be necessary to use honey water (2:1, water to honey) or pure honey in order to attract any bees or wasps. An alternative to using a tray of sugar water is to spray the bait on foliage.

If there is beekeeping in the area with bees other than *Apis*, visit and observe this type of beekeeping during an ensuing field trip.

Step 1: Bee Types (30 minutes)

Assemble the participants at a bait station. Ask them to point out wasps and other types of bees feeding at the station, then ask them to describe the features that distinguish bees from wasps and from other insects. Briefly discuss the various types of bees, both *Apis* and non-*Apis*, used by humans. Distinguish between the species and races of bees and show, on the map, the distribution of the four species of *Apis* and the major races of the western honey bee.

If possible, catch examples of the various insects and examine them with a hand lens.

Session 2: Types of Bees and the Bee-Human Relationship

Step 2: Desirable Bee Traits (25 minutes)

Question the participants about traits they consider desirable in bees for beekeeping. Discuss these traits and have a participant list them on the chalkboard. Point out that this is a hypothetical list and that in selecting a line of bees, it is necessary to make trade-offs among the various desired characteristics.

Step 3: The African Bee (25 minutes)

Ask the participants what they know or have heard about the African bee. Adapt this information to the characteristics of the African bee and relate the traits of the African bee to the list of desirable traits in bees.

Use **Handout 9** as a resource for a short lecture on the African bee. Discuss the traits of European bees and African bees. Point out the distribution of African races of Apis. Recount the history of the introduction of the African bee into South America and its impact on beekeeping. Discuss the need for adjusting management techniques used for European bees in temperate regions to both the behavioral characteristics of the African bee and to tropical conditions.

Point out that the African bee is easy to manage and relate this to the needs of small-scale beekeepers. Also, point out that because of the swarming tendency of African bees and their ability to exist as feral colonies in the tropics, they provide a ready and cheap bee resource for small-scale farmers who might like to start keeping bees.

Trainer Note

The timeliness and relevancy of this topic will vary greatly depending upon the areas in which the participants will be working. If more time is needed and/or if local resources are available on this topic, schedule more time.

Step 4: Bee-Human Relationship (25 minutes)

Discuss the phases of bee killing, bee having, and beekeeping in the development of the bee-human relationship. Relate these phases to the cultural and ecological factors that shape them. Ask participants what relevance to their future roles as Peace Corps Volunteers they see in understanding the development continuum of the bee-human relationship. Point out that in any development effort, it is important to recognize the stage of development of the local technology and to tailor appropriate goals and technologies to that situation.

Session 3: Anaphylactic Shock

Total Time

2 hours

Overview

A Peace Corps Medical Officer should lead this session. The session should be delivered at the beginning of any beekeeping program because participants may not know that they are allergic to bee stings.

People react in different ways to insect stings. It is important that the beekeeper know about the variety of possible reactions and what to do in extreme cases. This session gives the participant background information on the body's responses that cause anaphylactic shock and other less severe reactions. Participants will discuss the symptoms of anaphylactic shock and appropriate treatments. In addition, participants will gain awareness of the different emergency medical treatments that are available.

Objectives

- Describe the different levels of human body responses to bee stings
- Identify the causes of anaphylactic shock
- Practice treatment of anaphylactic shock victims
- List where the necessary materials for treatment are available in small communities
- Analyze the ethics and legal implications of treating severe reactions to bee stings

Resources

- <http://www.beesfordevelopment.org>
- *Small Scale Beekeeping* [M0017]
- *Lessons Learned from Beekeeping in the Philippines* [R0032]
- *The Hive and the Honey Bee*, by Dadant and Sons
- *The Bee Keeper's Handbook*, by D. Sammataro and A. Avitabile

Materials

Newsprint, markers, sting kit or treatment medicines, syringes, and oranges

Procedures

Step 1: Reactions to Stings (25 minutes)

Describe the variety of body responses to bee stings. Determine whether examples of the various reactions exist within the training group. Define anaphylactic shock.

Step 2: The Immune System (10 minutes)

Describe the human immune system and that reactions by the immune system produce the different responses to bee stings. Encourage questions and clarify doubts that may exist among participants.

Step 3: Treatment for Bee Stings (25 minutes)

Discuss various treatments, including folk treatments, for the different reactions to bee stings. Question the participants concerning what they have been told about this and how well treatments have worked with them.

Pass around different samples of sting kits and/or syringes and adrenalin for the participants to examine.

Step 4: Using a Syringe (20 minutes)

Simulate the proper way to give injections for anaphylactic shock by injecting an orange with water.

Step 5: Available Resources (20 minutes)

Tell participants to determine where sting kits or their components will be available in small communities or typical Peace Corps sites and to identify the personnel within a small community who would be adequately trained to recognize and treat bee sting victims.

Step 6: Ethical/Legal Implications (20 minutes)

Discuss the potential risks and ethics of treating an anaphylactic shock case from the viewpoint of a Peace Corps Volunteer in the absence of a professional health provider. Stimulate the discussion by considering such points as:

- Perceptions that the American beekeeper miraculously cures someone in a life-threatening situation
- What might happen if the treatment does not work
- Who is responsible for the victim's sting in the first place

Session 4: Bee Space and Types of Hives

Total Time

Approximately 2 hours



Overview

An understanding of the bee space provides the basis for constructing moveable-comb and moveable-frame beehives. This session addresses the bee space and its importance to hive types, factors that determine the types of hives used in various regions, problems with using Langstroth hives, and possible substitutes for high-technology inputs. This session will provide participants with technical, cultural, and ecological criteria for choosing an appropriate type of hive for areas where they will be working.

Objectives

- Define the bee space and its implications in hive design
- List, from an environmental, economic, and cultural standpoint, the pros and cons of various hive types (fixed-comb, moveable-comb, and moveable frame)
- List problems with using Langstroth hives for small-scale development projects and suggested solutions to address these
- Name the parts of a hive
- List alternative inputs for a Langstroth system

Resources

- <http://www.beesfordevelopment.org>
- *Small Scale Beekeeping* [M0017]
- *Lessons Learned from Beekeeping in the Philippines* [R0032]
- *The Hive and the Honey Bee*, by Dadant and Sons
- *The Bee Keeper's Handbook*, by D. Sammataro and A. Avitabile

Materials

Newsprint, markers, Langstroth hive, KTBH, pictures, slides or models of various hive types, and labels with the names of hive parts

Session 4: Bee Space and Types of Hives

Procedures

Step 1: Bee Space (30 minutes)

Ask the group what a bee space is.

Explain the application of the bee space in beehive construction.

Demonstrate the concept of bee space using the KTBH, the Langstroth hive, and the spacing of comb within the hive. Point out that bee space measurement varies among races of bees.

Step 2: Introduction to Hive Types (30 minutes)

Show various types of hives with models or photos. Use labels to identify the various parts of a hive. In addition, use labels in the language that the participants will use as Volunteers.

Step 3: Hives Types: Pros and Cons (30 minutes)

Refer to the List of Qualities developed in Step 2 of **Session 12: Hive Design Criteria and Swarm Boxes** and use **Handout 4A** in this session to guide the participants in listing the pros and cons of each hive type. Discuss the environmental, economic, and cultural factors that determine the pros and cons of each.

Step 4: Langstroth Hives in Small-Scale Development Projects (30 minutes)

Question the participants about problems they foresee with using Langstroth hives in development programs. Discuss and demonstrate the challenges with using Langstroth hives.

Touch on some commonly overlooked management options in small-scale development projects. Discuss the following:

- Exchanging boxes of the brood chamber to expand the brood nest
- Using two boxes for the brood chamber
- Storing drawn comb

Ask the participants to provide reasons that the beekeeper uses foundation and wire in frames. Elicit suggestions from the group about other options, such as starter strips and monofilament fishing line.

Handout 4A: Different Qualities of the Types of Beehives

	Fixed-comb Hive	Moveable Comb Hive	Moveable Frame Hive
Access to honeycomb	Often difficult	Easy	Easy
Access to brood nest for inspection	Usually impossible	Possible	Possible
Exchange and/or replacement of combs	impossible	Usually possible	Possible
Separation of brood comb from honeycomb	Impossible	Relatively possible	Possible
Materials necessary	Variable	Variable	Limited to wood
Possibility of increasing or decreasing space	Difficult	Possible	Very possible
Cost	Low	Intermediate	High
Carpentry skills and carpentry equipment needed	Low	Intermediate	High
Potential for management	None	Intermediate	High

Figure 4-1: Bee Space

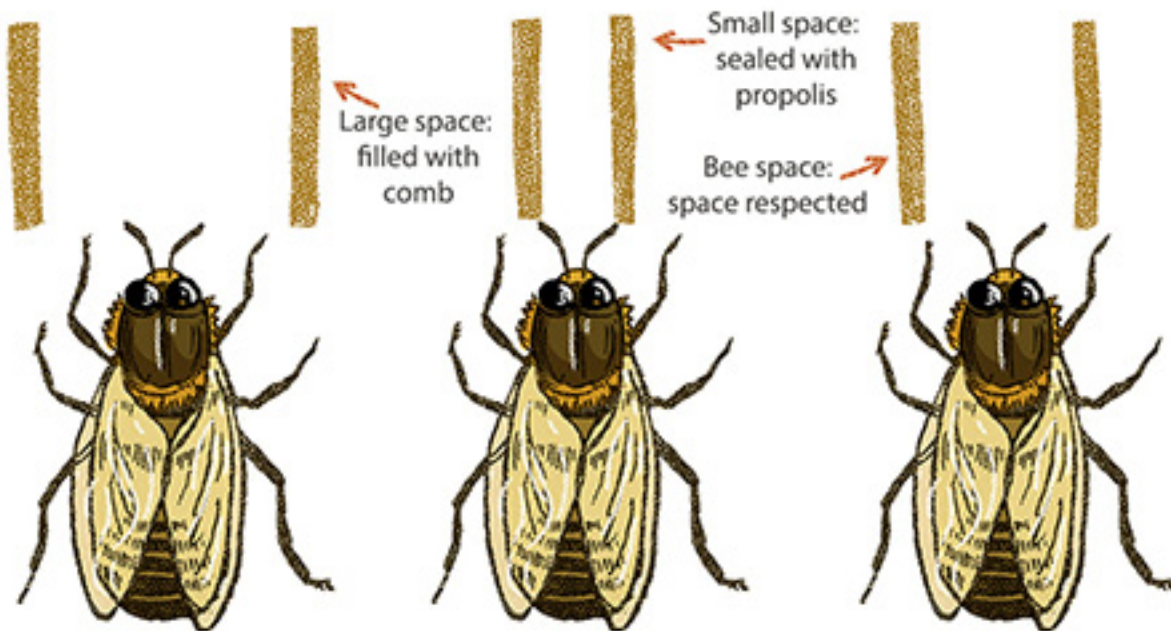

Total Time

Approximately 2 hours

Overview

An observation hive allows one to view the internal workings of a bee colony. As such, it is an important teaching/learning tool when set up in a conspicuous place. This session gives the participants experience in setting up observation hives. Since this is a group activity, the hives will provide a focus for group identity during the training program.

Staff and participants can informally assess their own experience and skills while establishing the observation hives.

Objectives

- Set up an observation hive
- Gain experience working in an apiary
- Identify potential uses of an observation hive in a beekeeping program

Resources

- <http://www.beesfordevelopment.org>
- *Small Scale Beekeeping* [M0017]
- *Lessons Learned from Beekeeping in the Philippines* [R0032]
- *The Hive and the Honey Bee*, by Dedant and Sons
- *The Bee Keeper's Handbook*, by D. Sammataro and A. Avitabile

Materials

Observation hives, nuc with ripe queen cells, sting kit (or adrenalin), smokers, matches, water sprayer, smoker fuel, water, hive tools, newsprint, and markers

Session 5: Observation Hive

Procedures

Trainer Note

Prior to beginning this session, select the colonies that will be transferred to the observation hives. Because no protective clothing will be available until a later session, it may be beneficial to hive well-fed artificial swarms into the observation hives.

This will be the first experience for many of the participants in working with a bee colony. Thus, it is important to stress the proper methods of working with bees and the precautions necessary to minimize stings.

Step 1: Introduction to Working in the Apiary (30 minutes)

Light a smoker and approach a hive correctly. Return to the group and have several participants re-enact the process.

Trainer Note

Coordinate with the Peace Corps medical officer to ensure that there are no known allergies and be prepared in case a Volunteer becomes allergic. Consult with the Peace Corps medical officer concerning how to best plan for potential stings.

Step 2: Setting Up the Observation Hive (1 hour)

Have the entire group approach and open the pre-selected hive.

Guide the participants in selecting appropriate frames for establishing the observation hives. Once the hives are filled and properly assembled, discuss the general impressions they have of this first experience with a hive.

Also, question the participants concerning the possible uses of an observation hive in beekeeping development work.

Since the hives will not be sited until evening, have the participants protect the glass hives from the sun and wind.

Session 5: Observation Hive

Step 3: Siting the Observation Hives (30 minutes)

Have a few volunteers move the observation hives from the apiary to their permanent sites, while the others prepare those sites.

Trainer Note

This step should be scheduled for late afternoon to ensure bees have calmed down after placing the frames in the glass hives.

Figure 5-1: Observation Hive

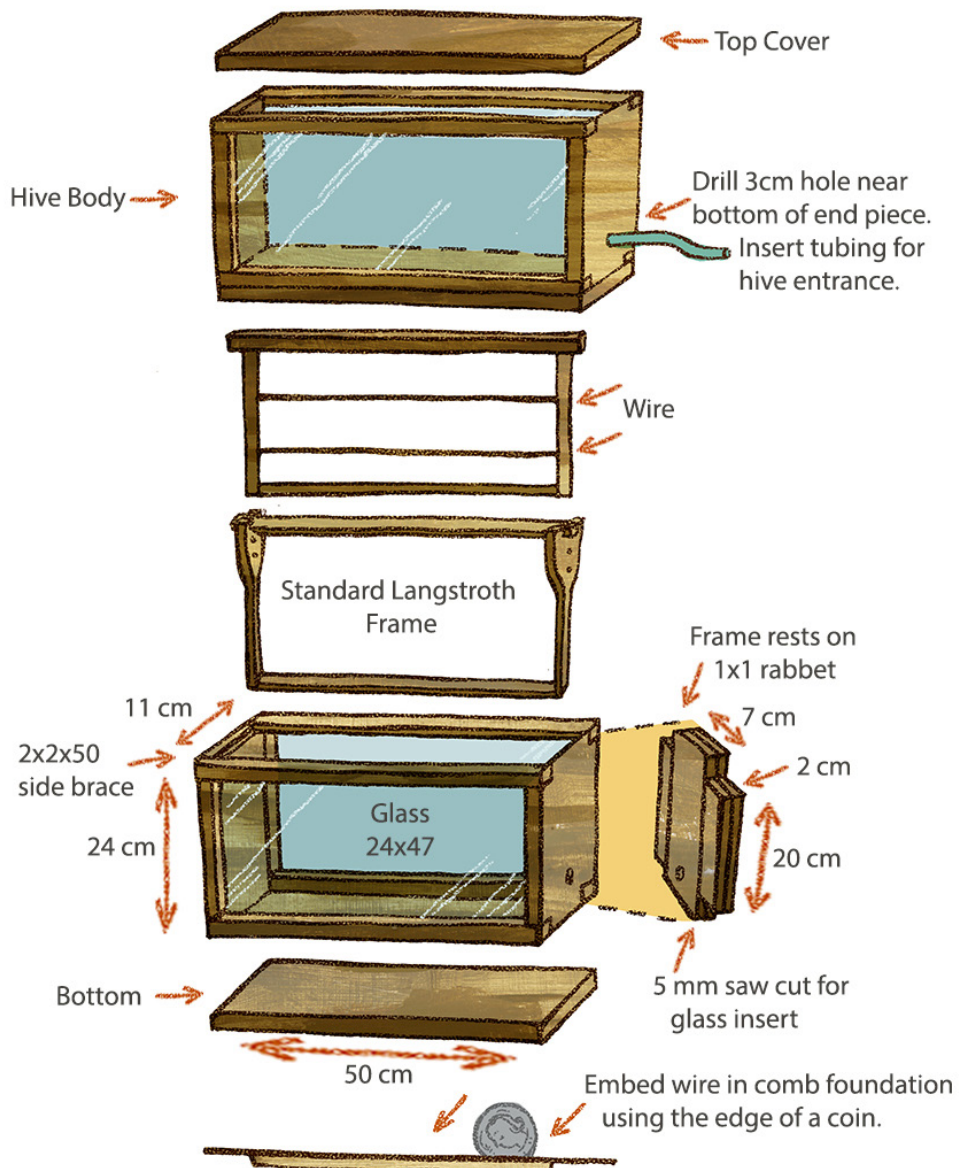

Session 6: Constructing KTBHs & Preparing the Apiary Site

Total Time

Approximately 6 hours

Overview

The Kenya Top Bar Hive (KTBH) is an intermediate technology hive. As such, it is consistent with the Peace Corps' philosophy of encouraging the use of local materials. In this session, participants will construct their own KTBH. The participants will also prepare an apiary site.

Objectives

- Discuss the principles of the KTBH
- Acquire/practice carpentry skills
- Construct an individual KTBH for the bee management sessions
- Construct KTBHs using local materials
- Prepare an apiary site
- Construct a dip board for making starter strips

Resources

- <http://www.beesfordevelopment.org>
- *Small Scale Beekeeping* [M0017]
- *Lessons Learned from Beekeeping in the Philippines* [R0032]
- *The Hive and the Honey Bee*, by Dedant and Sons
- *The Bee Keeper's Handbook*, by D. Sammataro and A. Avitabile

Materials

Hammers, saws and measuring tapes, wood chisels and paint brushes, wood, nails, thin sheet metal, wire/rope, a plane, paint, pencils, a KTBH, beeswax and starter strips, design plans for the KTBH and a clipboard, and material for constructing benches in the apiary (concrete blocks, two-by-fours or posts, depending on what is available)

Session 6: Constructing KTBHs & Preparing the Apiary Site

Procedures

Step 1: Introduction to the KTBH (1 hour)

Present a brief history of the KTBH, emphasizing its appropriateness for low-income settings. Point out the specifics of the KTBH construction using a hive or photos. Include such factors as modifications that allow for hanging the KTBH, the proper angle formed by the walls and base, how to make the top bars, and short-side entrances versus long-side entrances.

Ask the participants why it is important that the top bars be of the proper width and why the sides of the hive are inclined.

Discuss these two major principles of the KTBH and compare the short-side entrance to the long-side entrance. Encourage participants to experiment with the different locations.

In some regions where Volunteers may be working, building a KTBH out of wood may be impractical. Ask participants to suggest alternative materials and to point out the advantages and disadvantages of each. Encourage participants who will be going to regions (mainly sub-Saharan Africa) where wood is an impractical material, to experiment in building a KTBH out of alternative materials. Depending upon the availability and cost, other materials may include bamboo, mud and sticks, baked mud, cement, or 55-gallon barrels.

Step 2: Constructing an KTBH and a Dip Board (5 hours)

Have each participant build an individual KTBH. Have one or two participants who have good carpentry skills make a dip board.

Move among the groups as they are building the hives and offer suggestions or give demonstrations on building techniques.

Session 6: Constructing KTBHs & Preparing the Apiary Site

Trainer Note

Since top bars are time-consuming to make, it may be useful to have these made by a local cabinetmaker. Have grooves cut in most of the top bars so starter strips can be used on them; however, leave some top bars without grooves, so the participants can experiment with a line of beeswax on the top bar. (If all the top bars are grooved, some can be inverted in order to experiment with a line of beeswax.)

The participants will be sharing tools to build their hives; thus, they will naturally break into groups. Encourage participants with good carpentry skills to team with those who do not have such skills. This will facilitate the exchange of carpentry skills among the whole group.

There will probably be comments made about the lack of power tools. Take this opportunity to point out that Peace Corps Volunteers are often frustrated in their work by lack of equipment and support and that learning to use available resources is an integral part of being a successful Volunteer.

Making more starter strips should be a priority for Session 10 Bee Management Techniques since the starter strips will be needed as the colonies begin to grow. The equipment, other than the dip board, needed to make the strips can be assembled during this session by participants who have finished building their hives and have them sited in the apiary.

As some of the participants begin to finish their hives, remind everyone of the other tasks that need to be completed. Suggest that they paint their hives such that they allow enough time for them to dry. Those participants who finish early can help others who are slower.

Step 3: Preparing the Apiary Site (concurrent with Step 2) (5 hours)

As some of the participants begin to finish their KTBHs, briefly orient them to the basic principles involved in preparing an apiary site. Have them begin preparing the site and have others join them as they finish with their hives.

As the participants are preparing the site, ask them to express their reasons for choosing the site and for orienting the hives in the way they did. Use this information to generalize about the characteristics of a good apiary site. Point out that a perfect site is rare and that decisions must be made to maximize the desirable characteristics of a site. Discuss with participants the methods available to improve an apiary site.

Total Time

Approximately 2 hours



Overview

A good understanding of the bee colony cycle and the factors that affect it is essential for successful beekeeping. Overall hive management objectives during the cycle are the same wherever beekeeping is conducted. This session will cover the bee colony cycle, the management objectives during each part of the cycle, and practices used to ascertain the colony cycle for an area. This will prepare the participants to adapt their beekeeping skills to any area where they may be working.

Objectives

- Explain the bee colony cycle
- Explain the effects of weather on the cycle
- List management objectives and schemes for each part of the cycle
- List methods to ascertain colony growth, available bee plant resources, and the impact of weather patterns on the colony

Resources

- <http://www.beesfordevelopment.org>
- *Small Scale Beekeeping* [M0017]
- *Lessons Learned from Beekeeping in the Philippines* [R0032]
- *The Hive and the Honey Bee*, by Dedant and Sons
- *The Bee Keeper's Handbook*, by D. Sammataro and A. Avitabile

Materials

Blackboard, chalk, newsprint, markers, graph paper, and monthly temperature and rainfall charts of areas where the participants and counterparts will be working

Session 7: Bee Colony Cycle

Procedures

Step 1: Introduction (10 minutes)

Introduce the session with the idea that the activity in the colony changes throughout the year and, that as a result, management objectives change. Explain that the beekeeping cycle is basically the same everywhere that beekeeping is carried out.

Step 2: Graphing the Cycle (60 minutes)

Draw on the participants' observations and experiences to reproduce the population graph of the cycle. Introduce terminology for the bee cycle in the languages that the participants will be using as Volunteers.

Note that the bee cycle is influenced primarily by rainfall patterns in the tropics, while in temperate regions and in the subtropics, temperature patterns influence the cycle. Relate this to the flowering (nectar-producing) characteristics of plants in these regions.

Provide each participant with graph paper and make available, on newsprint, monthly temperature and rainfall data for the area where the participants will be working. Have the participants graph the data by months and then predict the bee colony cycle on the graph. Relate their predictions of the yearly growth and decline of the colony population to weather patterns in the areas where they will be working.

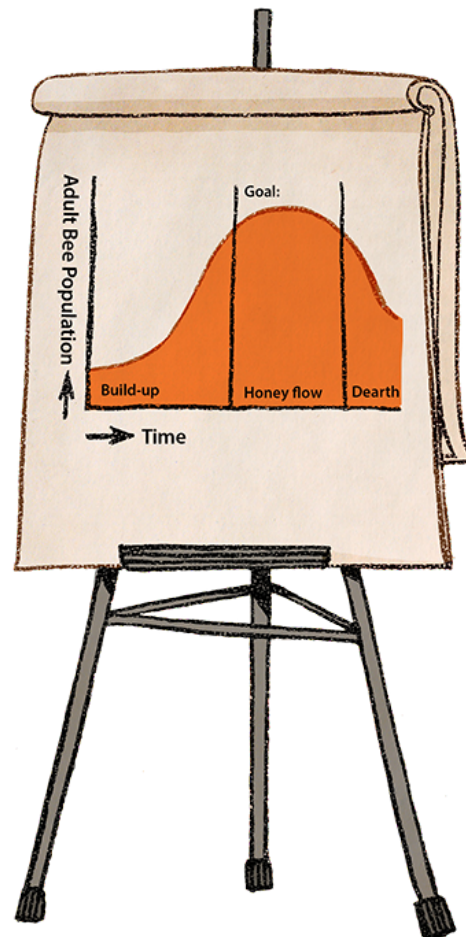

Step 3: Management Objectives and Schemes (50 minutes)

Discuss the overall management objectives for each portion of the cycle and examine the management practices used to meet these objectives. Point out that good beekeeping involves understanding the bee colony cycle and carrying out management operations at the right time. Have participants refer to **Handout 7A** for problems and solutions in beekeeping.

Handout 7A: The Essence of Beekeeping

Source: Jay, S.C. 1973. *Bee World*, 60(3): 140-142. International Bee Research Association.

A. Definition of Beekeeping

Beekeeping means managing honey bee colonies in such a way as to: (a) obtain a large (or maximum) adult colony population to coincide with the major honey (nectar) flows in the area, and (b) utilize this population to the beekeeper's greatest advantage for storing honey and/or pollinating crops.

B. Problems

Three basic challenges that beekeepers face globally and how to address these are featured in Figure 7-1.

Figure 7 1. Challenges to Beekeeping and Suggested Solutions

Challenge	Solution
Determining when the main honey flows occur	<ul style="list-style-type: none">• Conduct surveys to identify the major nectar and pollen-yielding plants within flight range of the bees, and that of these plants the bees visit, especially in large numbers.• Conduct surveys to record the flowering periods of these plants.• Make seasonal records of the weight of test colonies kept on scales.• Study farming practices in areas within flight range of the bees.• Examine weather records, soil data, and altitude variations.
Building up colony populations in preparation for the main flows	<p>Pay attention to:</p> <ul style="list-style-type: none">• Queen rightness and queen performance of each colony• Apiary sites• Arrangement of the colonies within apiaries• Care of overwintered colonies in spring, and/or care and introduction of packages of bees• Feeding methods and types of food• Control of diseases and pests• Swarm prevention• Provision of adequate hive space for brood and for nectar

Handout 7A: The Essence of Beekeeping

Challenge	Solution
Deciding what to do with colonies during the post-flow periods	<ul style="list-style-type: none">• Ignore colonies after the nectar flow.• Use surplus bees to increase the number of colonies• Kill off colonies• Use bees to build combs for future use <p>In temperate regions:</p> <ul style="list-style-type: none">• Reduce the numbers of bees in colonies for wintering• Winter the colonies where they are, or move them to another outdoor site, or indoors <p>In the tropics:</p> <ul style="list-style-type: none">• Maintain colonies at reduced populations

C. Where Beekeeping is Most Successful

Beekeeping appears to be most successful today in parts of the world where:

- Large areas of bee forage are available at specific predictable times of year
- Good flying weather prevails during the honey flows
- Movable frames are used in hives

D. Final Word for Commercial Beekeepers

One of the main objectives of the commercial beekeeper in managing hives is, as quickly as possible, to reach the stage where he or she can start to manage an entire apiary as a single unit, not as a group of individual colonies. He or she will then be in a position where each hive in an apiary will be ready to receive the same treatment at the same time (feeding, supering, drug control, queen check, etc.).

Session 8: Assembling Protective Clothing

Total Time

Approximately 4–6 hours, including time to identify a local seamstress and get the veil made

Overview

Protective clothing is essential for a confident beekeeper. Adequate protection will vary according to personal preference, the type of bee, the time of year, the time of day, and the condition of the hive. Well-made protective clothing allows the beekeeper to work effectively without worry. The veil protects the eyes and face from the bees; generally, it is the single piece of equipment most often used by people working regularly with bees.

In this session, participants become familiar with the basic features of protective clothing. Furthermore, they have the opportunity to interact with a local tailor or seamstress to have a veil made.

Objectives

- List desirable attributes of protective clothing
- Acquire a bee-proof veil and hat
- List difficulties associated with procuring hats, veils, gloves, and bee-proof suits
- Communicate and negotiate with local craftsfolk who sew protective clothing
- Share experience and insights gained through interaction with the local community

Resources

- <http://www.beesfordevelopment.org>
- *Small Scale Beekeeping* [M0017]
- *Lessons Learned from Beekeeping in the Philippines* [R0032]
- *The Hive and the Honey Bee*, by Dedant and Sons
- *The Bee Keeper's Handbook*, by D. Sammataro and A. Avitabile

Materials

Veil or screening material (dark color), muslin cloth, string, money, scissors, tape measures, elastic (or strips of tire tube), and examples of: a veil, hat, gloves, and bee-proof suit

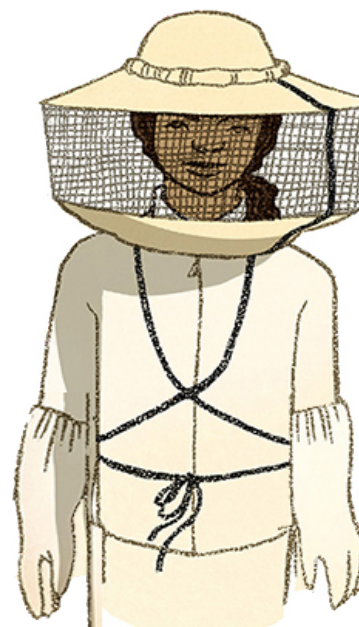

Session 8: Assembling Protective Clothing

Procedures

Step 1: Desirable Attributes of Protective Clothing (30 minutes)

Ask one of the participants to assist in this activity by modeling various articles of protective clothing as they are described. Elicit suggestions from the participants as to what they desire for protective clothing. As the participants are describing the clothing, point out and have the model demonstrate various important features of appropriate clothing.

Stress that comfort and dependability are the two most essential assets in selecting personal beekeeping apparel.

Step 2: Assigning the Tasks (15 minutes)

Explain to the participants that their task is to have a veil made locally by a tailor or seamstress to whatever specifications they desire. Also, point out that this is an opportunity to buy hats, if necessary.

If necessary, provide the participants with suggestions regarding how to locate a local seamstress or tailor by questioning people in the marketplace and providing addresses of local craftspeople.

Explain that, if the participants finish early, they should take advantage of the time to:

- Check on honey availability and prices
- Determine other types of services available such as carpentry shops and hardware stores
- Find out about the local transportation system
- Investigate the foods available locally
- Determine the availability of other beekeeping equipment and supplies

Step 3: Assembling Materials (15 minutes)

Have the participants gather the plans or materials that they decide can best convey the desirable attributes for their veil. Be certain that each participant assembles enough materials to meet his or her needs.

Trainer Note

The materials for making the veils should be on hand and possibly divided into individual packets for the participants to take to the seamstress or tailor.

Session 8: Assembling Protective Clothing

Step 4: Locating a Seamstress or Tailor (4 hours)

Have each participant locate a tailor or seamstress, specify what clothing is needed, negotiate a price, and pick up the finished product.

Step 5: Presentation of Veils and Discussion (1 hour)

Ask the participants to demonstrate their veils to the group and explain how they conveyed the information and where a tailor or seamstress was located. Ask them to share any information they obtained about local beekeeping activities, available supplies, and any other relevant insights.

Figure 8-1: Veil Dimensions

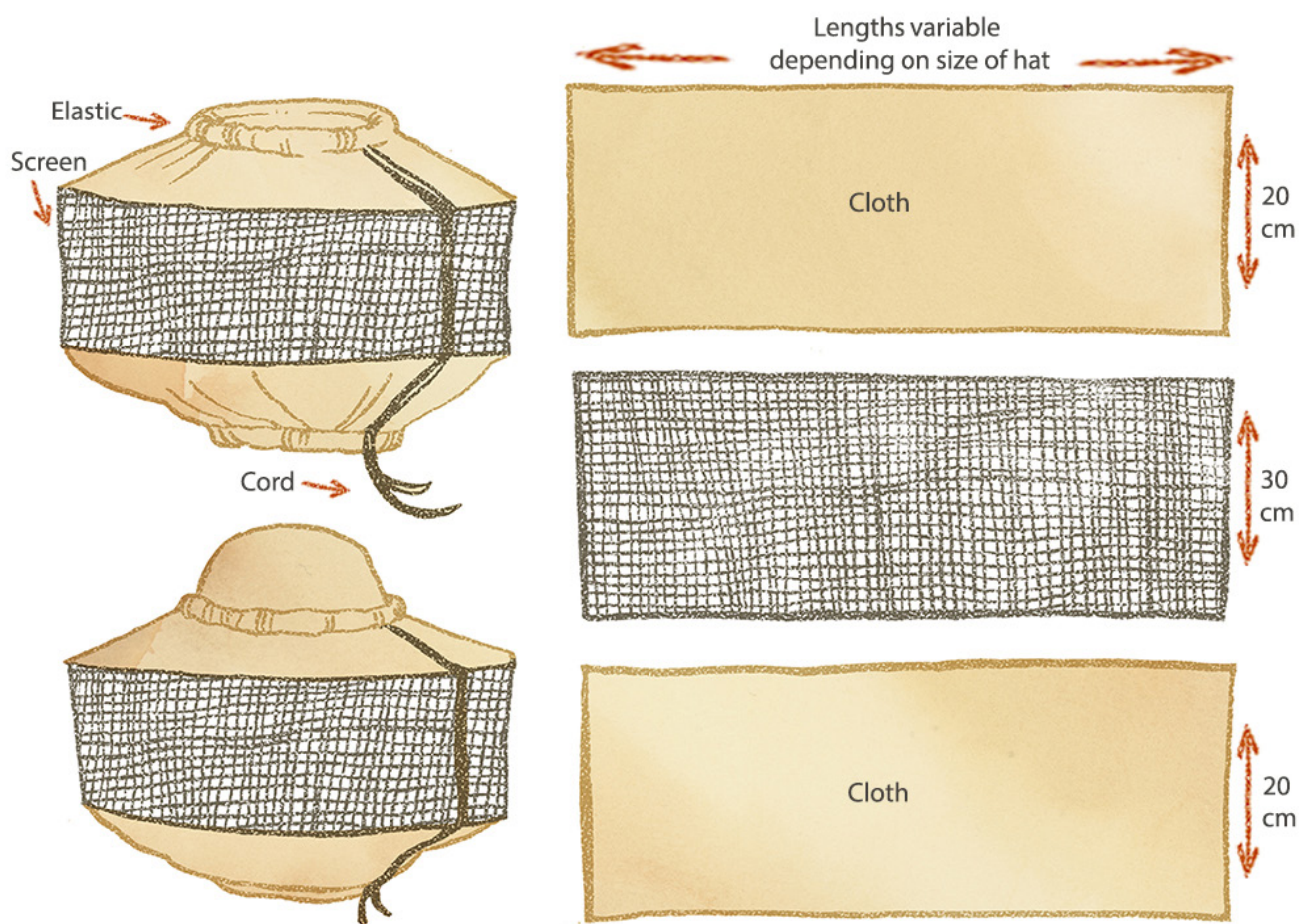

Session 9: Establishing Individual Nucs

Total Time

Approximately 4 hours

Overview

This session will provide participants with experience in establishing a hive by dividing a colony. The participants will plan the task and then implement what has been planned. For some, this will provide the first hands-on experience working with bees.

Objectives

- Demonstrate how to light a smoker properly
- List desirable attributes of smoker fuels
- Make a hive division
- Establish an individual hive
- Practice cutting out and transferring queen cells
- Keep records on the hives

Resources

- <http://www.beesfordevelopment.org>
- *Small Scale Beekeeping* [M0017]
- *Lessons Learned from Beekeeping in the Philippines* [R0032]
- *The Hive and the Honey Bee*, by Dedant and Sons
- *The Bee Keeper's Handbook*, by D. Sammataro and A. Avitabile

Materials

Individual KTBHs, ripe queen cells, pocket knife, notebooks, pens, various smoker fuels, matches, smoker, and water sprayer

Session 9: Establishing Individual Nucs

Procedures

Step 1: Introduction (30 minutes)

Before starting work in the apiary, ask the participants to share their conceptions of the tasks of dividing a hive and establishing a nuc. If any participants have experience in these areas, ask them to explain these processes to the group. Remind the participants that as they will be working with strong colonies, they should wear proper protective clothing.

Step 2: Smoker Fuels and Lighting a Smoker (90 minutes)

Have available some examples of various materials used for smoker fuel. Discuss what smoker fuels may be available in the areas where the participants will be working. Ask some of the participants to light the smokers. Have other participants describe what is happening and elicit suggestions from them as to how to more effectively light the smoker. Point out the purpose of using smoke and describe the desirable qualities of a good smoker fuel.

Emphasize the following points:

- Have a good fire in the bottom of the smoker before packing it with fuel.
- Use fuel that produces a cool, white smoke. Suggest putting green plant material on the top of the fuel to accomplish this.
- Pump the bellows periodically when working in the apiary so the smoker remains lit.
- Use a water sprayer to control highly defensive bees

Step 3: Demonstrating a Hive Division (30 minutes)

Have a participant demonstrate cutting out and transferring of queen cells, attaching comb to top bars, and shaking bees into a hive. Stress the importance of observing carefully and asking questions during this demonstration.

Trainer Note

Since this will be the participants' first independent work in the apiary, it is important for them to understand fully what they are doing in order to reduce any confusion. As many of them will be working with strong colonies for the first time during this session, some may receive multiple stings and become frustrated and/or exasperated.

Step 4: Establishing Individual Hives (90 minutes)

Have the participants establish their individual nucs and start records on their activities.

Session 9: Establishing Individual Nucs

Trainer Note

It is important that participants feel that the nucs are theirs.

Have at least two ripe queen cells for each participant.

Remind the participants that record keeping is important and that they should start maintaining records on their hive. Emphasize that they should record information when it is observed, not later, when it may be forgotten or confused. Encourage them to develop individual styles of record keeping that will benefit them.

Periodically, encourage the participants to share their recorded information to improve upon their own style of record keeping.

Once the participants have established their nucs with ripe queen cells, it is best to wait a couple of days before disturbing the colony.

Figure 9-1: Cutting Out and Placing Queen Cells

1. Cut around the queen cell. Be careful not to cut into the cell.
NOTE: Do not turn the queen cell on its side as this may injure the developing pupa.
2. Cut a section out of the face of the comb into which you will put the queen cell.
3. Place the queen cell in the section that has been cut out.
REMEMBER: Always keep the cell pointed downward.
4. Put the comb into the colony. The bees will seal the queen cell to the comb.

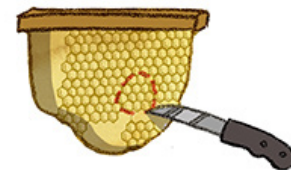
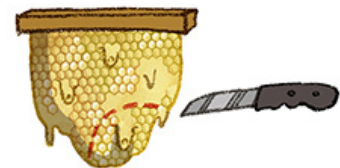

Handout 9A: European vs. African Bees

European

- Adapted to temperate zones
- Wild colonies do not have a high rate of survival in the tropics
- Little swarming in the tropics
- Little absconding (migrating)
- A long association with beekeepers (i.e., characteristics have been selected as more desirable from the point of view of beekeeping)
- Gentle
- Do not run on the frames
- Respond to management
- Begin active foraging at a relatively higher level of resource availability
- Strategy for survival is to maximize the survival of the individual (colony) (i.e., emphasis is on the storage of provisions)

African

- Adapted to tropical zones
- Wild colonies are very common
- Much swarming
- Much absconding
- Have been hunted by bee killers for gathering honey (i.e., no selection of desirable traits)
- Aggressive
- Run on the frames
- Do not respond well to management
- Forage actively at relatively lower level of resource availability
- Strategy is to maximize the number of individuals (colonies) (i.e., emphasis is on producing more colonies)

Session 10: Bee Management Techniques

Total Time

Sessions 10 to Session 17, done consecutively, total approximately 37 hours

Overview

Beekeeping is both an art and a skill. As such, the only way to become a beekeeper is to practice the craft. Sessions 10–17 provide trainees with experience in working their own individual hives while being guided by experienced beekeepers. Trainees will gain confidence in their own observational and beekeeping skills as they have a chance to practice them independently. They will gain new skills as they respond to the changing conditions in their hives. Furthermore, as the trainees will be working together in the apiary, these sessions will provide an opportunity for them to practice their information transfer skills.

Objectives

- Work bees individually
- Respond to the ongoing situations in a bee colony and in the apiary
- Establish an arena for peer learning of beekeeping skills
- Practice various bee management techniques

Resources

- <http://www.beesfordevelopment.org>
- *Small Scale Beekeeping* [M0017]
- *Lessons Learned from Beekeeping in the Philippines* [R0032]
- *The Hive and the Honey Bee*, by Dedant and Sons
- *The Bee Keeper's Handbook*, by D. Sammataro and A. Avitabile

Materials

Smokers, smoker fuel, hive tools, protective clothing, individual hives, and other materials (depending upon the situation that arises)

Session 10: Bee Management Techniques

Procedures

Step 1: Work in the Apiary (variable times)

Have the trainees work on their individual hives or projects.

Trainer Note

Sessions 10–17 form the backbone of the beekeeping training. They provide the opportunity to respond to many different beekeeping situations as they actually occur. As hives are being managed, a wide range of beekeeping problems and situations will arise. This gives the trainees both an opportunity to observe and respond to the situation, in addition to practicing their extension skills with other trainees.

Be available to the trainees during these sessions and guide them in their observations and working techniques. As the training program progresses, the trainees should need less guidance.

While many of the topics covered in these sessions will be treated in other sessions, cover topics as they arise in the apiary. Respond to the situation. Never pass up a chance to teach about an aspect of beekeeping when the opportunity presents itself.

Point out bee disease and pest situations whenever they are encountered. Trainees should see as many of these situations as possible. Mail a laboratory sample for disease verification early in the training program so the results will return before the program ends.

In addition to those management techniques covered in specific sessions, practice the following techniques during these sessions:

- Diagnosing the brood pattern (condition of queen, disease, pests)
- Adding brood comb to the brood nest to alleviate a honeybound condition and stimulate brood production
- Preventing and stopping robbing
- Switching colonies to equalize population
- Feeding bees
- Providing water for bees
- Removing old combs
- Combining colonies
- Caging queens
- Extracting honey
- Mailing disease samples

Session 10: Bee Management Techniques

Step 1: Field Trip (variable times) (alternative)

Take a field trip to observe the bee management techniques of local beekeepers.

Guide the trainees in making observations on the social, economic, and cultural milieu of small-scale beekeepers. Facilitate observations of those factors that, in general, limit agricultural development and those that specifically impede beekeeping development.

Trainer Note

Observing local beekeepers and their techniques provides an opportunity for the trainee to gain both technical and cross-cultural skills. Field experience will give trainees a perspective to better adapt their beekeeping knowledge to their future work situation.

A field trip to observe a beekeeper extracting honey during the early part of the training program is a valuable experience for those trainees who have no beekeeping experience. As harvesting honey is the beekeeper's reward, seeing this activity provides direction to beginning beekeepers.

The scheduling and content of field trips is dependent upon the convenience of local beekeepers. As such, they may occur at variable times during the training period.

Total Time

2 hours



Overview

Foraging fulfills the resource needs of the bee colony. The quality, quantity, and location of available forage affects behavioral responses of both individual bees and the colony. Practicing marking and following foragers in the field allows participants to observe resource needs of, and communication in, the colony.

Objectives

- Define the resource needs of the colony
- Analyze factors that determine the types of forage collected
- Mark bees
- Examine foraging behavior
- Observe and discuss colony communication

Resources

- <http://www.beesfordevelopment.org>
- *Small Scale Beekeeping* [M0017]
- *Lessons Learned from Beekeeping in the Philippines* [R0032]
- *The Hive and the Honey Bee*, by Dedant and Sons
- *The Bee Keeper's Handbook*, by D. Sammataro and A. Avitabile

Materials

Observation hive with bees, blackboard, chalk, several colors of fast-drying paint, jar lids, sugar, water, honey, watch/timer, screen wire, container (1 liter), notepaper, pens, and small container to hold captured bees

Session 11: Foraging

Procedures

Step 1: Reviewing the Resource Needs of the Colony (10 minutes)

On newsprint, list and review the resource needs of the colony. Define terms pertinent to this session, such as forage, forager, and communication dance. Encourage comments and discussion.

Step 2: Defining the Activity (10 minutes)

Explain that participants will establish a feeding station. Bees captured by the participants from the observation hive will be fed on honey or sugar syrup and marked with a spot of paint. Observing the marked bees' behavior upon returning to the observation hive will allow participants to study communication in a beehive.

Ask the participants what equipment is needed and why.

Step 3: Collecting the Equipment (15 minutes)

Gather the necessary equipment for marking bees. Have participants volunteer to be in charge of mixing various concentrations of sugar syrup or getting honey, capturing bees, marking bees, and timing the bees' return flight to the colony.

Step 4: Capturing the Bees from the Observation Hive (15 minutes)

Demonstrate how to capture bees leaving the observation hive. Have the participants capture 10 to 15 foragers.

Trainer Note

One way to capture bees is to fit a container formed from screen wire over the entrance tube of the observation hive. Bees will enter the container as they leave the hive. These bees will be old enough to be foragers and, therefore, will be able to locate and return to the colony once released in the field.

Step 5: Marking and Feeding Bees (30 minutes)

Demonstrate how and where to mark bees. Have the participants mark several bees. Feed the marked bees on the sugar syrup or honey. Record the time at the feeding station. Also, note the time needed for the marked bee(s) to return to the feeding station. Note any recruitment

Session 11: Foraging

from the observation hive. Ask participants if using honey or sugar syrup would elicit different responses from the observation hive during various times in the beekeeping session. Explain that during a nectar flow, honey will elicit more response from the colony.

Explain that some of the foragers will communicate a false location of the feeding station. Point out that this is because they will communicate the location of their original forage source, prior to being captured and fed at the feeding station.

Also, during this activity point out and discuss foraging behavior.

Step 6: Observing and Discussing Colony Communication (25 minutes)

Return to the observation hive. Observe any marked bees in the hive. Discuss the communication dances observed in the colony. Explain how differences in forage, differences in location of forage, and other forage factors affect the communication process. Discuss forage characteristics that make it attractive to bees.

Trainer Note

Use the following alternative in situations where participants want to divide into groups to establish many feeding stations:

Have participants establish another feeding station in another location and at a different distance. Mark the bees a different color. Note differences in the communication within the colony.

Another variation is to use different concentrations of sugar syrup at a feeding station.

Session 12: Hive Design Criteria & Swarm Boxes

Total Time

Approximately 2 hours

Overview

Understanding beehive design parameters and the design process is important in assessing and introducing an appropriate beekeeping technology. In this session, participants develop a list of beehive design criteria by drawing upon their own experiences in building and setting up a beehive. They then use some of these parameters to design an improved swarm box. The information and skills developed in this session will help participants determine whether beekeeping equipment and systems are appropriate for the areas where they will be working.

Objectives

- Develop the parameters for designing beehives
- List different qualities of beehives
- Design an improved swarm box
- Present and evaluate designs of swarm boxes
- List the basic concepts of the design process

In regions where the African bee is present and swarm boxes are useful in beekeeping:

- Construct and test an improved swarm box or Johnson hive
- Practice/acquire carpentry skills

Resources

- <http://www.beesfordevelopment.org>
- *Small Scale Beekeeping* [M0017]
- *Lessons Learned from Beekeeping in the Philippines* [R0032]
- *The Hive and the Honey Bee*, by Dedant and Sons
- *The Bee Keeper's Handbook*, by D. Sammataro and A. Avitabile

Session 12: Hive Design Criteria & Swarm Boxes

Materials

Chalkboard, chalk, sample piece of five-mesh hardware cloth (five holes per 2.54 centimeters), newsprint, markers, Langstroth hive, and KTBH

Procedures

Step 1: Beehive Design Parameters (35 minutes)

Point out that establishing design parameters is the first step in the overall design process. Relate this to the session objectives.

Ask participants about the parameters that are important in beehive design. Guide the group in developing the following list:

- Cost
- Access to honeycomb
- Access to brood nest for inspection
- Exchange and/or replacement of combs
- Separation of brood comb from honeycomb
- Materials for increasing or decreasing space
- Carpentry skills and carpentry equipment
- Potential for management

Step 2: Swarm Boxes Introduction (10 minutes)

Ask participants to speculate on the design and function of swarm boxes. After swarm boxes are defined, ask the group about the appropriateness of swarm boxes in beekeeping. Relate the appropriateness of swarm boxes, both to the socio-economic factors of the beekeepers and to the characteristics of the bees in the area.

Step 3: Designing an Improved Swarm Box (35 minutes)

Show the participants a sample piece of five-mesh hardware cloth and introduce the idea that it can serve as a low-cost queen-excluder. Ask them to design an improved swarm box (or simple hive) based on the following criteria:

- Give access to honeycomb
- Provide separation of brood comb from honeycomb

Session 12: Hive Design Criteria & Swarm Boxes

- Built in three hours
- Made up of only wood, nails, and hardware cloth
- Built only with hand tools
- Be practical as a swarm box

Emphasize that in the design process, specific criteria such as these are more useful than general ones.

Have the participants work either in groups or individually to design an improved swarm box.

Provide participants with newsprint and markers so they may prepare their designs for presentation to the group.

Step 4: Presentation of Designs (25 minutes)

Have participants present their designs. Allow time after each presentation to give feedback on the presentation and design. Ask participants what they liked best about the presentations and the swarm box designs and what suggestions they might have for improvement.

Step 5: Conclusion (15 minutes)

Introduce the design plan of the Johnson hive. Ask participants how their designs differ from, or are similar to, the Johnson hive. Ask them what difficulties they may have in attempting to introduce either the Johnson hive or their designs to local beekeepers.

Question the participants about the next step to take after completing a design. Develop, on the board, the following overview of the whole design process:

Figure 12-1: Design Process

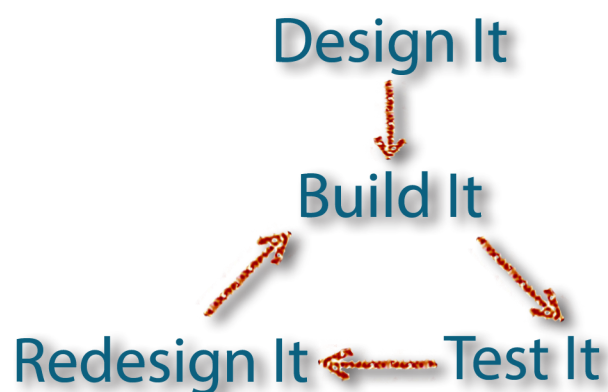

Session 12: Hive Design Criteria & Swarm Boxes

Emphasize that no design is complete until it has been tested and retested and that every new design requires redesign and rebuilding.

Relate the design process to the role of a Peace Corps Volunteer by pointing out the importance of being flexible and remaining open to new ideas and situations.

Trainer Note

If participants will be working in areas where swarm boxes are valuable to beekeepers (i.e., in areas where there is a high incidence of swarming in the local bee population), it will be valuable for them to actually build a Johnson hive or an improved swarm box of their own design.

Session 13: Transferring Colonies

Total Time

Approximately 8 hours

Overview

Transferring colonies from fixed-comb hives (either wild or rustic hives) is an important method of obtaining bees in beekeeping. This session will provide experience in both transferring colonies and in transporting hives to new sites. Transferring a colony is often difficult work and is usually traumatic to the colony. Successfully completing a transfer will greatly increase participants' confidence in working with bees.

Objectives

- List the factors involved in transferring and transporting a hive
- Analyze social and economic conditions of beekeepers who use rustic hives
- Transfer bees from a rustic colony to another type of colony
- Transport hives

Resources

- <http://www.beesfordevelopment.org>
- *Small Scale Beekeeping* [M0017]
- *Lessons Learned from Beekeeping in the Philippines* [R0032]
- *The Hive and the Honey Bee*, by Dadant and Sons
- *The Bee Keeper's Handbook*, by D. Sammataro and A. Avitabile

Materials

Colonies in a rustic hive, smoker and fuel, machete, water, either a KTBH or Langstroth hive, hammer, nails, saw, screen wire, string, knife, bucket, and towels

Session 13: Transferring Colonies

Procedures

Trainer Note

In order to provide each participant with a chance to participate in this aspect of bee management, have several rustic colonies available. It may be necessary to travel to several places to find a sufficient number of colonies.

As dusk is the best time to close colonies for transporting, this session may end later than usual. Explain this beforehand so that, if necessary, the participants may arrange their time.

Step 1: Introduction (45 minutes)

Have the participants describe what they already know about transferring a colony. Be sure they understand the importance of quickly disorienting the colony as much as possible to minimize stinging. A good way to do this is to turn the colony upside down.

Discuss various alternatives in the transferring process and potential problems. Emphasize that transferring colonies is difficult work and that they should expect to be stung; also explain that it is a great learning experience for practical beekeeping skills.

Discuss the process of, and the points to consider when, transporting bees.

Have a participant take charge of assembling all of the equipment needed to make the transfers.

Step 2: Transferring and Transporting Colonies (variable time depending on distance to be traveled)

Have participants make several hive transfers. Move among the participants as they are working and offer suggestions. Facilitate observations on the social and economic condition of those beekeepers with rustic hives.

Have the participants prepare the colonies for transporting and carry the hives to the new apiary site.

Session 13: Transferring Colonies

Figure 6-17: Transferring a Colony

1. A fixed-comb hive.
2. Move the fixed-comb hive away from its original site and put a KTBH in its place.
3. Open the fixed-comb hive and remove the comb one-by-one.
4. Put combs with honey in a dishpan covered with a damp cloth to prevent robbing and discard combs that have drone brood.
5. Attach worker brood combs to top bars and put them in the KTBH.
6. After all the comb is cut out, dump the remaining bees into the KTBH, close the hive, and reduce the entrance.

NOTE: Move the old, fixed-comb hive out of the apiary to prevent the bees from being attracted to it.

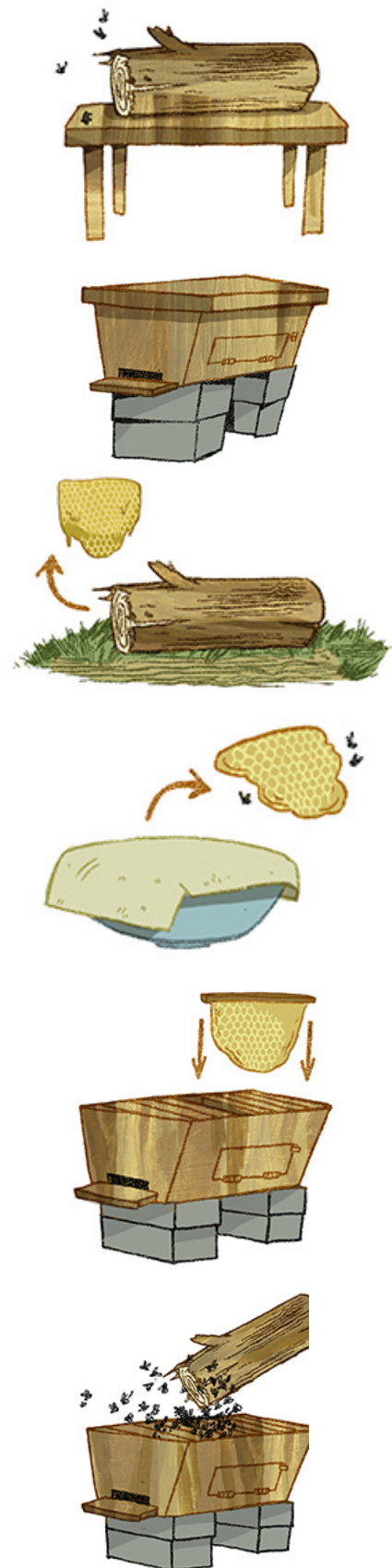

Total Time

Approximately 12 hours

Overview

Queen rearing is advanced beekeeping. Successful queen rearing combines knowledge of bee biology with good beekeeping skills. This exercise allows participants to learn about and practice various queen-rearing techniques. The emphasis is on relatively simple methods that are appropriate for the settings where the participants will be working. Experience in queen rearing will increase the beekeeping credentials of the participants in their future work situations.

While carrying out the queen-rearing activities, participants will develop and evaluate extension pamphlets. This will provide the participants with experience in preparing written materials and visual aids appropriate for use with small-scale farmers. Such skills will be important in participants' future roles as beekeeping Volunteers.

Objectives

- List the principles of queen rearing
- Plan and assemble the equipment needed for queen rearing
- Write extension materials appropriate for use by Peace Corps Volunteers
- Select frames of brood appropriate for rearing queens
- Prepare a finishing colony
- Remove ripe queen cells from the finishing colony
- Establish mating nucs
- Demonstrate queen rearing

Resources

- <http://www.beesfordevelopment.org>
- *Small Scale Beekeeping* [M0017]
- *Lessons Learned from Beekeeping in the Philippines* [R0032]
- *The Hive and the Honey Bee*, by Dedant and Sons
- *The Bee Keeper's Handbook*, by D. Sammataro and A. Avitabile

Session 14: Queen Rearing

Materials

Sheets of foundation, screen wire, strips of sheet metal, knife, queen excluder (or five-mesh hardware cloth), frame with empty comb, two swarm boxes with young bees, several strong colonies, finishing colony, several empty frames, pins, string, mating nuc boxes, colored markers, newsprint, pens, paper, and ruler

Procedures

Step 1: Introduction to Queen Rearing (1 hour)

Review and elaborate upon the biology of queen production in a bee colony. Relate the various methods of queen rearing to the biology of the bee colony, i.e., the fact that methods of queen rearing are based on artificially creating the conditions of natural queen rearing in the colony.

Explain and discuss the basic guidelines for selecting queen mother colonies.

Step 2: Defining the Activities (1 hour)

Outline the basic format of the remaining activities of this session. Explain that the participants will divide into two groups and that each group will use a different method to rear queens. One group will use the Beetsma method and the other will use the Miller method. Each group will also prepare extension pamphlets and present demonstrations of their chosen queen-rearing method. Explain that they will have 10 hours to accomplish the task.

Outline the reasons for developing extension materials and discuss the appropriate criteria. Discuss what audience is being considered and how to meet the needs of this audience. Pass around examples of extension materials for examination and discussion. Explain that the participants will evaluate each other's materials for effectiveness in meeting the following criteria:

- Use of simple, concise language
- Presenting technical concepts clearly and correctly
- Use of simple, clear illustrations, that are adapted to the culture of the intended audience

Point out that the demonstrations will be used to inform each other about queen-rearing methods. Explain that each group will evaluate each other on their demonstrations.

Session 14: Queen Rearing

Stress the importance of effectively working together to accomplish the tasks. Point out that the materials and demonstrations must be completed by the end of this session.

Trainer Note

Handouts 14A and 14B are provided as references and as examples of extension materials prepared by Peace Corps participants and Volunteers. The illustrations in the original materials are not included.

Step 3: Carrying Out the Activities (10 hours)

Have the participants divide into two groups and carry out the activities outlined in Step 2.

After the demonstrations, evaluate the design and facilitation of the demonstrations. Also, review and comment on the effectiveness of the visual aids used.

Have each group present its extension materials. Help the participants to review and comment on the effectiveness of the materials in achieving their purpose and addressing the target audience. Suggest variations in style or alternative formats, if necessary.

Trainer Note

Circulate between the groups to provide assistance, encouragement, and advice, if needed.

Handout 14A: Queen Rearing- Beetsma Method

The Beetsma method is a simple way for any beekeeper to raise queens.

Materials Needed

- Strong queenless colony (queenless for 24 hours)
- Frame of empty medium-aged wax comb
- Razor blade and/or sharp knife
- Frame with removable bars
- Wire, string, and/or wax
- Record keeping materials

Procedures

1. The object is to find young larvae, 1 to 3 days old. Obtain a frame of larvae of the same age. If this is unavailable, find an empty frame to place into a brood chamber of a strong queen-right colony. This will result in larvae of the same age. All other frames in the colony must be filled to make sure that the queen can lie only in the empty frame.
2. Cut the comb into strips. For ease of cutting, select medium-aged brood comb (not too dark). The strips should be four or five cells wide and they should contain larvae. Remove one side of the strip to the base of the comb.
3. Take the strip that has been cut in half and attach to the top bar. Firmly attach the comb by wax, string, or straight pins.
4. Attach the bar into an empty frame. Two of these bars may be placed in one frame.
5. Place this frame into a strong queenless colony. Conditions in the colony:
 - No other queen
 - No other uncapped brood
 - Nutritious food (honey and pollen)
6. Sixteen days after the eggs were first laid, the new queens will emerge. It is important to separate queen cells a day before the queens are expected to emerge. If this is not done, the queens will kill each other.

Handout 14B: Queen Rearing- Miller Method

Total Time

Approximately 5 hours

The Miller method is a simple way for any beekeeper to raise queens. However, two conditions are necessary for successful queen rearing by the workers in the colony:

- A time of year when sunshine is plentiful and it is neither too cold nor extremely hot.
- A time when plenty of bee plants are available as forage, as nectar and pollen are necessary food for the workers to raise new queens.

Why is it necessary to raise queens?

Young queens are the strongest and the most productive egg layers and therefore can produce larger field forces under build-up conditions.

It is necessary to raise a new queen when:

- The queen has died in a colony.
- The beekeeper has a queen that is failing in a colony.
- The beekeeper wishes to make new colonies (divisions).

Necessary Equipment to Raise Queens

- A strong colony (queen mother colony) with a good queen (the queen mother)
- A bottom board, a top, two boxes without frames, and metal screening to close the entrance (This equipment is used to make up a cell-building colony.)
- A frame without wire with a half sheet of foundation well pegged to the frame with melted wax
- A large feeding bottle with sugar syrup
- Ten frames of comb or foundation
- Approximately 10 percent of the total number of colonies in the apiary should be nucs. This allows a number of queens to be on reserve for future requeening purposes

Handout 14B: Queen Rearing- Miller Method

Steps to Follow (Approximately 30 minutes each)

Step 1

Choose a queen mother from a strong colony. The queen mother colony should exhibit as many of the following characteristics as possible:

- Has gentle workers
- Produces a lot of honey
- Is disease-resistant
- Has a solid and even brood pattern
- Does not exhibit a tendency to swarm

The queen mother colony should have seven to 10 frames of brood. Also, it is necessary to have frames of sealed honey and frames of stored pollen to raise a good queen.

Step 2

Put the bottom board and empty box for the cell-building colony on top of a hive stand. Close the entrance with metal screening.

Step 3

Remove one frame of pollen and one frame of sealed honey from the queen mother colony. Put these two frames into the middle of the empty box.

Step 4

Find the queen in the queen mother colony. Place her in the cell-building colony, along with a frame of brood (along with the bees on that frame of brood).

Replace the three frames removed from the queen mother colony with the frames of foundation.

Step 5

Have a frame, without wire, ready. Put in a half-sheet of foundation. The foundation should be well pegged to the top of the frame with melted wax.

After this half-sheet is drawn out, the queen will lay her eggs on this frame, as it is the only available space.

Handout 14B: Queen Rearing- Miller Method

Step 6

Shake the bees from four frames of unsealed brood into the cell-building colony.

Step 7

Place an empty box on top of the cell-building colony. Put the feeding bottle filled with sugar syrup on top of the frames inside this colony. Close this colony with the top.

Step 8

Three days after establishing the cell-building colony, open the entrance of the colony and check to see if all of the sugar syrup has been consumed. Refill if necessary.

Step 9

Destroy all of the queen cells in the queen mother colony seven days after establishing the cell-building colony. Carefully check each frame of brood while looking for the queen cells.

Also, destroy (cut out) older (larger) larvae since good queens will not develop from them.

The beekeeper cannot accurately determine the age of the larvae in the queen cells in the queen mother colony. Therefore, it is preferable to use the young larvae (of known age) that will be placed in the nucs to be raised into queens.

Step 10

Remove the frame without wire from the cell-building colony seven days after establishing the colony. Carefully brush the bees from the frame. This frame should have only small, young larvae. Care must be taken not to kill the queen while checking this colony.

Find the smallest larvae and cut the comb from underneath those cells. Be sure to cut away all drone cells.

The smallest larvae will produce the best queens. By cutting away the comb from underneath these larvae, the beekeeper is providing enough room for the worker bees to build queen cells.

Note: Although it generally takes seven days after establishing the colony for the larvae to be ready, check the colony after five days since, under some conditions, the larvae may be ready earlier. Under other conditions, it may take up to 10 days before young larvae will be found on the comb.

Handout 14B: Queen Rearing- Miller Method

Put this cut-comb frame into the strong queen mother colony between frames of brood. The worker bees will build queen cells from the young larvae.

Step 11

Fill the cell-building colony with frames of comb or foundation so the queen has space available to lay eggs.

Step 12

Remove the cut-comb frame from the queen mother colony 10 days after placing it in the colony (Step 10).

Sealed queen cells should be apparent. Carefully brush away the bees. Never shake or turn queen cells on their sides.

Carefully cut around the queen cells. Allow room around the cell so that the cutting in no way disturbs the developing queen.

Cut out from a frame of brood an area equivalent to the size of the queen-cell comb. Press the comb surrounding the queen cell into the comb on the frame of brood. Be sure that the queen cell is fixed firmly on the comb.

Put this frame with the queen cell into a queenless nuc.

Step 13

Unite the cell-building colony with the queen mother colony.

Step 14

Check the queen-mating nucs to see if the queen is laying two weeks after introducing the queen cells.

Session 15: Swarming, Supersedure, and Absconding

Total Time

Approximately 2 hours



Trainer Note

Note that this session is related to **Session 16: Constructing a Swarm Board and Swarms**, which is also participant-facilitated. Ideally, the same participant should facilitate both sessions.

Overview

Swarming, supersedure, and absconding are behavioral responses of the colony to changing environmental conditions. As such, the beekeeper employs various management techniques to control or utilize these responses to meet specific needs of the hive or apiary.

The beekeeper needs to recognize the differences between swarming, supersedure, and absconding and to understand the conditions that trigger these responses. With this understanding, beekeepers can appropriately manipulate the colony to achieve management objectives.

Objectives

- Define swarming, supersedure, and absconding
- Analyze why bees swarm, supersede, and abscond
- List indicators of swarming, supersedure, and absconding
- Present the management techniques to control swarming, supersedure, and absconding
- Analyze the advantages and disadvantages of swarming in relation to the type of hive used

Resources

- <http://www.beesfordevelopment.org>
- *Small Scale Beekeeping* [M0017]
- *Lessons Learned from Beekeeping in the Philippines* [R0032]
- *The Hive and the Honey Bee*, by Dadant and Sons
- *The Bee Keeper's Handbook*, by D. Sammataro and A. Avitabile

Session 15: Swarming, Supersedure, and Absconding

Materials

Newsprint, markers, tape, blackboard, chalk, a hive, and frame of comb (without bees)

Procedures

Trainer Note

Prepare the visual aids for Step 2 prior to beginning the session.

Step 1: Defining Swarming, Supersedure, and Absconding (20 minutes)

Ask participants about the differences between swarming, supersedure, and absconding. List the general characteristics of each and draw simple diagrams to indicate where on a comb the queen cells would occur.

Step 2: Cause of Swarming, Supersedure, or Absconding (40 minutes)

Write, on strips of newsprint, environmental factors and conditions within the colony that cause or indicate swarming, supersedure, and absconding. Distribute these strips to the participants and write the words “swarming,” “supersedure,” and “absconding” across a blackboard. Have the participants post the strips under the appropriate heading and discuss their reasons for doing so.

Point out that each of these phenomena are caused by a complex of factors rather than isolated factors.

Step 3: Management Techniques (30 minutes)

Using an empty hive and frames of comb, demonstrate the conditions of swarming, supersedure, and absconding. Discuss with participants the management options that might be utilized to control the situation.

Step 4: Advantages and Disadvantages of Swarming (15 minutes)

Discuss the advantages and disadvantages of swarming. Include such factors as attitude of the beekeeper, the equipment, and the race of the bee.

Direct the discussion toward the concept of using swarm boxes to capture swarms. Discuss this as a form of bee-having.

Session 15: Swarming, Supersedure, and Absconding

Figure 15-1: Swarming, Supersedure, and Absconding

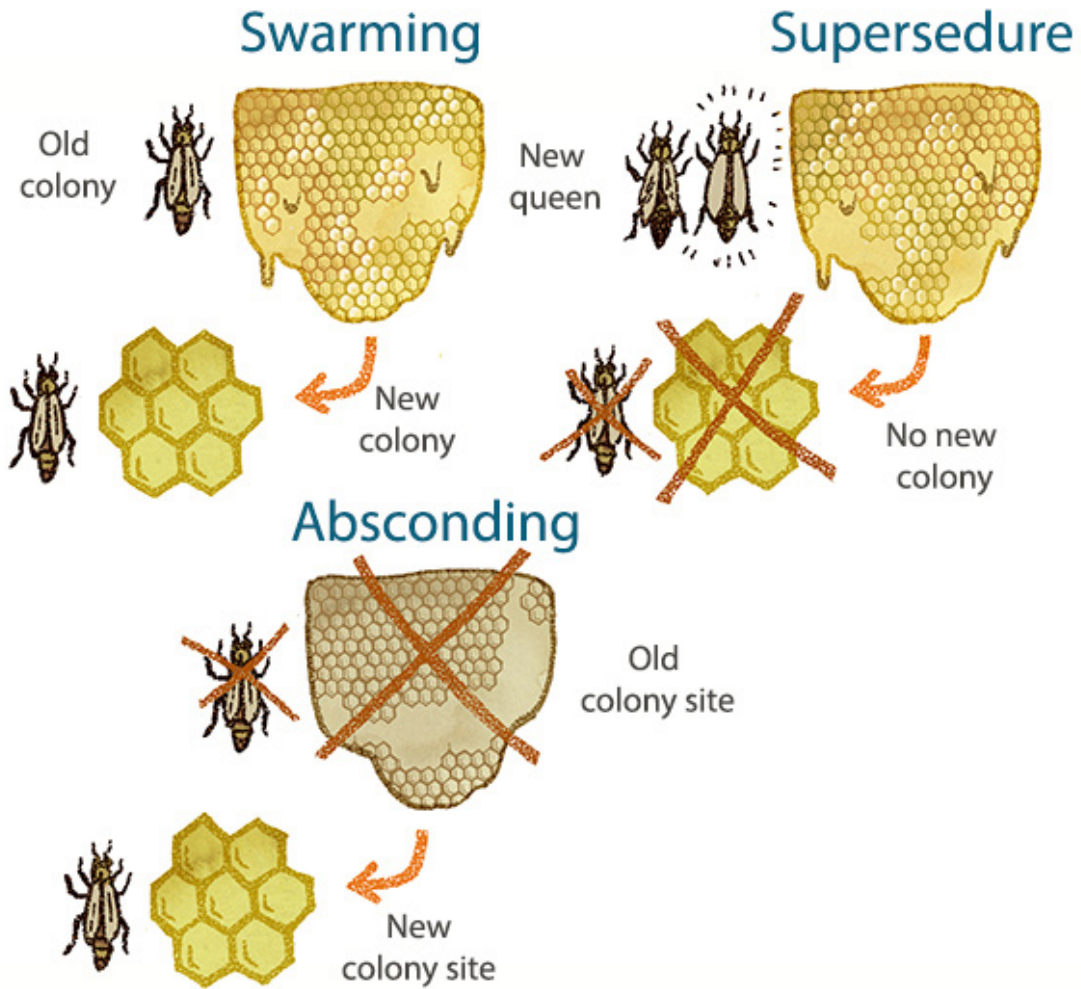

Session 16: Constructing a Swarm Board and Swarms

Total Time

Approximately 6 hours



Overview

A swarm board is a simple piece of equipment useful for making and observing artificial swarms. A swarm board allows a beekeeper to observe a swarm and its efforts to select a new hive site. A beekeeper can also gain experience in hiving a swarm from a swarm board. This session provides participants with an understanding of colony-swarming behavior by making an artificial swarm, observing it, and then hiving it. Participants will also make bee beards that are good attention getters at bee fairs and other extensions.

Objectives

- Construct a swarm board
- Practice/acquire carpentry skills
- Create an artificial swarm
- Explain the nature of beehives
- Hive a swarm
- Make a bee beard

Resources

- <http://www.beesfordevelopment.org>
- *Small Scale Beekeeping* [M0017]
- *Lessons Learned from Beekeeping in the Philippines* [R0032]
- *The Hive and the Honey Bee*, by Dedant and Sons
- *The Bee Keeper's Handbook*, by D. Sammataro and A. Avitabile

Materials

Wood, nails, hammers, saws, tape measure, hardware cloth (big enough for bees to pass through), rope or wire, two queen cages, tin snips, sugar water, water sprayer, newsprint, markers, bait hives, two colonies of bees, and various colors of fast-drying paint

Session 16: Constructing a Swarm Board and Swarms

Procedures

Trainer Note

Steps 1 through 3 should be in the afternoon, as this is the best time for making artificial swarms. Steps 4 through 8 should be scheduled for the following day.

Step 1: Introduction (30 minutes)

Have the participants speculate as to the design and use of a swarm board based on what they have learned in Session 16. Swarming, Supersedure, and Absconding. Explain the details of a swarm board and how it is used to create an artificial swarm. Also, discuss the use of bait hives (often called swarm boxes). Touch on the parameters of location, dimension, shape, and orientation.

Step 2: Constructing Swarm Boards (40 minutes)

Have the participants divide into groups of approximately six participants each and have each group build a swarm board.

Trainer Note

Circulate between the groups to offer suggestions where appropriate.

Step 3: Making an Artificial Swarm and Setting Up Bait Hives (1 hour)

Have the swarm board construction groups each make an artificial swarm and hang it in an accessible site for observation. Before starting, discuss how to correctly cage a queen and have the participants practice with drones until they feel confident. While the bees are clustering, have the participants set up some bait hives in various locations.

Step 4: Observation of the Swarms and Bait Hives (40 minutes)

Have the participants feed the swarms by spraying them with sugar water. Facilitate a discussion of the behavioral activities of swarming while the participants are observing the swarms.

Have the participants move bees in the swarm with their fingers to demonstrate how docile the bees are while in a swarm.

Session 16: Constructing a Swarm Board and Swarms

Have the participants observe whether scout bees have located the bait hives set up the previous day. Mark scout bees with paint and observe their behavior when they return to the swarms.

Step 5: Swarming Differences Between European and African Bees (20 minutes)

While observing swarming behavior, explain the behavioral differences between swarms of European and African bees.

Step 6: Bee Beards (2 hours)

Elicit suggestions from the participants on how to make bee beards using the knowledge they have acquired about swarms and swarming behavior. Have participants make bee beards. Point out that making a bee beard is an effective publicity ploy since it demonstrates how a knowledgeable beekeeper can manipulate bee behavior.

Step 7: Hiving the Swarms (35 minutes)

Using open-ended questions, list what supplies need to be in a hive about to receive a swarm of bees. Make sure the participants have placed eggs, brood, pollen, and honey in the hives. Caution the participants not to put more brood in the hive than the swarm will be able to care for. Discuss whether the scout or forager bees will be included in the colony or if they will be lost in the field. Have participants prepare the hives and hive the swarms.

Session 17: Extractors and Solar Wax Melters

Total Time

Approximately 20 hours



Trainer Note

The format of this session is somewhat different from that of the other participant-facilitated sessions. Once the session is introduced, the participant-facilitator will be responsible for coordinating the activities of the construction groups. After the equipment is constructed and tested, the participant will facilitate the review of the design and construction process.

Overview

Planning, designing, and constructing equipment are important skills for beekeeping Volunteers.

An extractor is a necessary component to any high technology beekeeping system. It is a specialized piece of equipment. The many design options available permit it to meet specific needs.

A solar wax melter is a useful, low-cost, and effective tool appropriate for all beekeeping management systems. A wax melter allows the beekeeper to begin the process of rendering the wax, thereby facilitating wax moth control. Furthermore, the solar wax melter can economically render small quantities of wax that encourages the saving of beeswax.

The participants, working in groups, will discuss, plan, and design an extractor and a solar wax melter. They will practice group interaction skills while considering the availability of various tools and materials, as well as the appropriateness (cost vs. effectiveness) of the equipment design to their future extension work.

Finding suppliers for needed materials and equipment is often difficult for development workers. Once planned and designed, the participant groups will buy the materials needed to construct the extractor and solar wax melter. Interacting with local merchants while procuring the needed equipment will enable participants to develop an appreciation for what, where, and when materials are available.

This session will provide participants with transactional, cross-cultural, and technical skills. The experience acquired from planning, constructing, and analyzing the final products will be useful in helping participants to develop their own appreciation for appropriate technology; thus, aiding them to develop technologies appropriate to their future sites.

Session 17: Extractors and Solar Wax Melters

Objectives

- List design criteria of extractors and solar wax melters
- Plan the construction and the purchase of materials
- List technologies appropriate to the work situation of Peace Corps Volunteers
- Purchase materials needed to construct the extractors and solar wax melters
- Construct extractors and solar wax melters
- Practice construction skills
- Test the extractors and solar wax melters, evaluating them for modifications
- Review the design and construction processes of the extractors and solar wax melters

Resources

- <http://www.beesfordevelopment.org>
- *Small Scale Beekeeping* [M0017]
- *Lessons Learned from Beekeeping in the Philippines* [R0032]
- *The Hive and the Honey Bee*, by Dadant and Sons
- *The Bee Keeper's Handbook*, by D. Sammataro and A. Avitabile

Materials

Paper, pencils, chalkboard, cash, and materials decided upon by the participants

Procedures

Step 1: Planning and Designing (2 hours)

Outline the entire session to the participants and list the objectives.

Ask participants to describe the desired attributes of an effective extractor and solar wax melter. Have a participant list these attributes. Consider designs appropriate to their future work situations. Show plans, pictures, or simple drawings to illustrate points. Discuss various options available.

Have the participants divide into groups of six for the remainder of the session and provide each group with plans, including **Handout 17A** and resource materials useful for designing the equipment to be made.

Session 17: Extractors and Solar Wax Melters

Have each group design an extractor and solar wax melter and make a list of materials and tools needed.

In preparation for Step 2, have participants plan their purchasing trip by forming small buying teams and having them estimate the amount of cash needed.

Step 2: Purchasing Materials (4 hours)

Have participants purchase the materials determined in Step 1. Remind the participants to obtain receipts for all purchases and to keep cost records on their projects.

Trainer Note

Translators may be needed to facilitate the purchase of materials in some areas. However, encourage participants to work as independently as possible.

Step 3: Constructing and Testing (12 hours, 30 minutes)

Have the participant groups construct their extractors and solar wax melters. Encourage participants to divide the tasks to make the most efficient use of the resources available. During the building exercise, facilitate discussions concerning what happened during the buying trips.

When the extractors and solar wax melters are completed, have the participants test them.

Trainer Note

As the groups are working, keep in touch with how they are proceeding and provide assistance whenever it seems appropriate. Be careful not to intervene so much as to inhibit independent problem solving within the groups.

If the need for more materials arises, have one or two participants from each group purchase them while the other participants continue working.

Allow time to clean the work area after construction.

Step 4: Review of Design and Construction Process (1 hour)

Facilitate a review of the design and construction process. Critique the finished equipment. Discuss the lessons learned from the exercise and elicit suggestions for modifications regarding the session and the equipment. Discuss how the groups worked together during the session and suggest ways of helping the groups to work more effectively.

Handout 17A: Making and Using a Solar Wax Melter

From: An extension leaflet by Elbert R. Jaycox, University of Illinois at Urbana-Campaign

A solar wax melter is a glass-covered box that uses the heat of the sun to melt beeswax and to separate it from honey and other materials found in honey bee colonies. The melter can be used to render old combs, cappings, burr combs, and other hive scrapings containing wax. It is also handy for removing beeswax from excluders. The melter produces wax of high quality and eliminates the need for the sometimes-hazardous job of rendering wax in the home.

The sloping top surface of the solar wax melter provides maximum exposure to the sun and allows honey and melted wax to drain quickly into the storage pan. Before use, the entire unit, including the sheet metal pan, should be painted black for maximum heat absorption. The glass cover, with two sheets of double-strength glass about one-fourth-inch apart, helps to retain the absorbed heat. The fiberboard insulation also serves the same purpose. Internal temperatures, well above the melting point of beeswax (about 145 degrees Fahrenheit or 63 degrees Celsius), are maintained on warm sunny days. Place the melter in a sunny, sheltered spot for best results.

The attached plan is intended to inspire ideas about how to build a melter. You need not copy the plan exactly. For this reason, many dimensions are not provided, especially the less important ones. Modify the dimensions to fit your needs, or the materials available, but beware of making it too small. The sheet metal pan should be 4 to 6 inches deep and big enough to accept excluders (16 1/4 -by-20 inches) or at least two full-depth frames (19-by-20 inches). Consider the possibility of making one or more cappings baskets of expanded metal that will fit into the sheet metal pan.

The pan to catch the hot honey and melted wax should be relatively large to prevent accidental overflows. A plastic dishpan works well. The wax can be easily removed because it does not adhere well to the smooth, flexible plastic. Sloping sides on the pan also make it easier to remove the cake of wax.

The wooden brace is designed to support the lid while you clean out the slumgum, or residue, that remains after combs are melted. It lies between the exterior box and the interior layer of insulation. The finger hole, or notch, is used to pull it into place. Cut the free end at an angle so it makes firm contact with the lid frame when the lid is a suitable height to work beneath.

The melted wax will flow more easily down the pan if the combs, excluders, and capping baskets are set on lengths of metal rods or angle iron. You should also put a coarse screen across the outlet of the pan to keep unmelted pieces of comb and other debris from flowing into the pan of molten wax. Honey collects beneath the wax in the pan. It is darkened and unsuitable for human food, but can be used to feed bees in early spring (not in the fall). The slumgum remaining in the sheet metal pan contains beeswax that can be removed only by

Handout 17A: Making and Using a Solar Wax Melter

a hot water press. If you accumulate 100 pounds or more, it is worthwhile having it rendered commercially.

The melter is highly attractive to robber bees because of the odors given off by the warm honey and wax. It should be kept tightly closed except when loading it or removing the filled collecting pan.

Figure 17-1: Solar Wax Melter- Side View

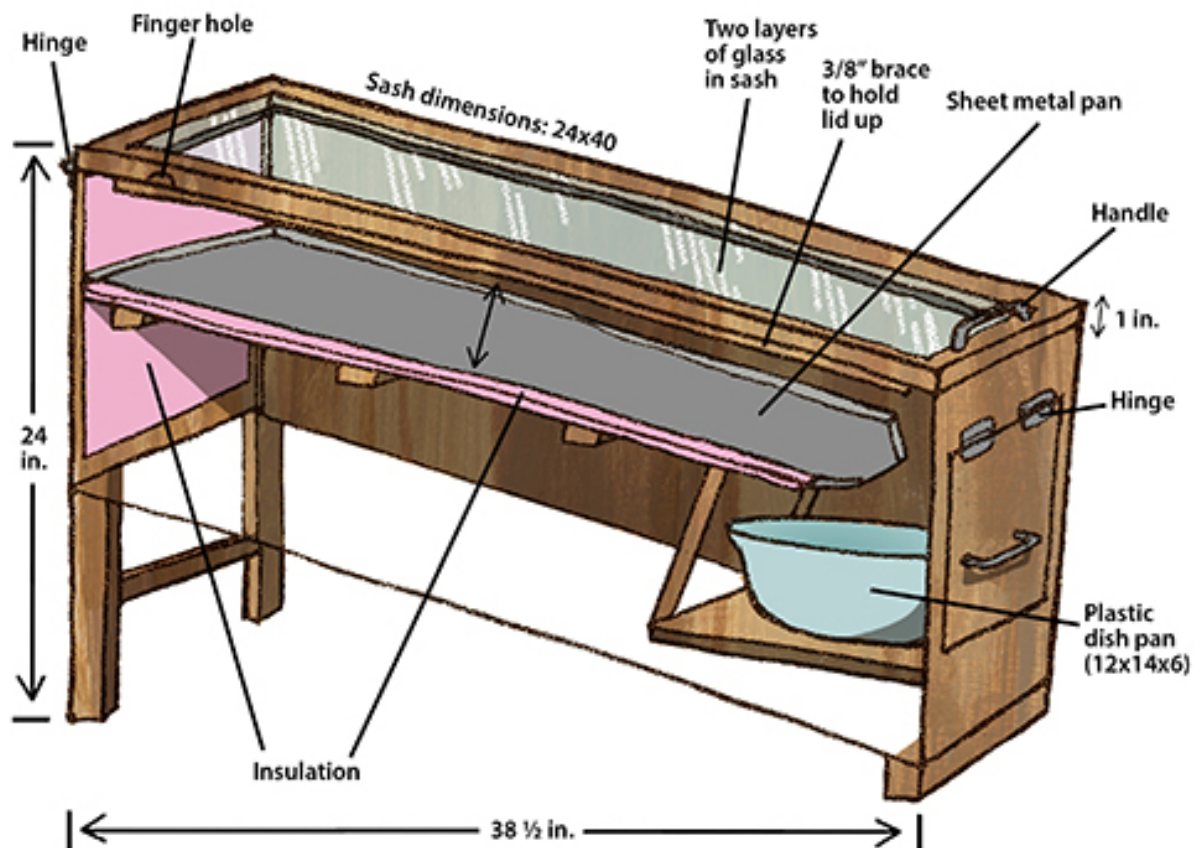

Handout 17A: Making and Using a Solar Wax Melter

Figure 17-2: Solar Wax Melter- Front/Back View

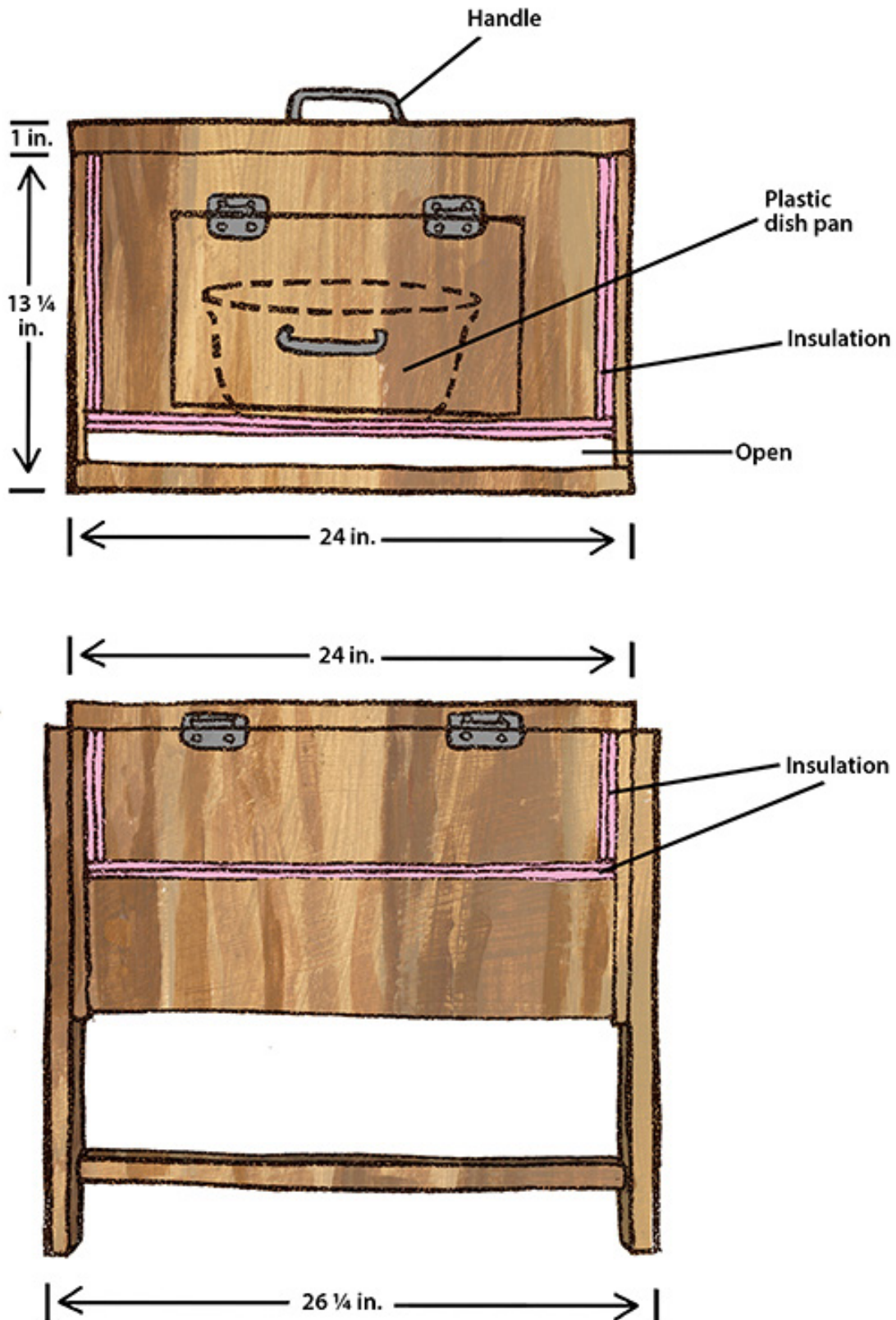

Session 18: Gender and Development- The Role of Men and Women in Beekeeping

Total Time

2 hours

Overview

Given that men are more often responsible for “cash” crops, men perform the work of collecting honey and working with bees. Because women are traditionally responsible for the upkeep of the household, they may not venture far from the home, nor be accustomed to climbing trees, both of which are typically required in beekeeping. As a result, most women would never imagine working with bees. At the same time, products of the hive can be crafted into materials that women particularly appreciate. Some women may be brave enough to venture into beekeeping, but even if they are not, they can work with men in the community to add value to hive products, through, for example, the creation of candles and lotions.

An understanding of the roles of men and women within a culture is an important part of the personal and professional life of a Peace Corps Volunteer. This session will allow participants to take a closer look at the complexity of gender equity issues within beekeeping. Participants identify traditional roles of men and women while discussing their reactions to them as North Americans. They examine ways these roles will influence both their professional lives as Peace Corps Volunteer beekeepers and their personal lives as individuals adjusting to a new culture.

Objectives

- Review the concept of Gender and Development
- Review the traditional roles of women in the host country
- Evaluate these roles in light of personal values and perspectives
- Identify ways to recognize and deal with women in development issues in beekeeping projects
- Examine personal needs regarding emotional and sexual relationships with others

Resources

- <http://www.beesfordevelopment.org>
- *Small Scale Beekeeping* [M0017]
- *Lessons Learned from Beekeeping in the Philippines* [R0032]
- *The Hive and the Honey Bee*, by Dedant and Sons
- *The Bee Keeper's Handbook*, by D. Sammataro and A. Avitabile

Session 18: Gender and Development- The Role of Men and Women in Beekeeping

Materials

Newsprint and markers

Procedures

Trainer Note

Depending on where and when the training is being held, participants may need country-specific information on the traditional roles of men and women in order to complete Step 2. If necessary, the trainer should be prepared to provide this information in the form of a lecture or readings.

Step 1: Definition of Gender and Development (25 minutes)

Review the session objectives and discuss the definition of the terms Gender and Development. Write down some of the definitions on newsprint. Briefly identify reasons for treating Gender and Development issues in this beekeeping-training program.

Step 2: Traditional Roles (45 minutes)

Have the participants make a list of what they perceive to be the traditional roles of men and women in the communities where they are working as Peace Corps Volunteers. Have them reflect upon their family live-in experiences as a source of ideas. Ask participants to individually look over the lists and think about the aspects of these roles they consider to be positive and negative.

Have them divide into small groups and discuss the following:

- Why do we perceive some of these roles as positive and others as negative?
- Which aspects of North American culture influence our reactions?
- Why do these roles exist?
- Why have they evolved as they have?
- Now that you have been living in your host community, what do you perceive to be the positive or negative aspects of each of the roles attributed to the men and women you have observed?

Session 18: Gender and Development- The Role of Men and Women in Beekeeping

Step 3: The Impact of Traditional Roles On Beekeeping (50 minutes)

Reconvene the large group and conduct a round table discussion of the conclusions developed by the small groups. Ask the group to reflect upon how these roles may affect them as beekeeping Volunteers. Distribute Handout 17A and focus a discussion on the following points:

- What else do you need to find out about gender roles in your communities of assignment?
- How can you learn more?
- What are some strategies for appropriately integrating men and women into beekeeping projects?

Summarize the major recurring themes and solicit suggestions from the group regarding how they plan to cope with gender role behaviors that they consider to be negative.

Handout 18A: Strategies for Integrating Women in Development Projects

- Asking, listening, and observing to identify women's needs
- Identifying women's roles, opportunities, and constraints
- Identifying cultural, social, family, and other patterns that affect women positively and negatively
- Identifying, developing, and using women leaders and supportive men
- Identifying positive and negative effects of projects on women and children
- Helping in the development and advancement of women counterparts
- Developing and implementing income-generating activities or projects for women
- Integrating women into decision-making levels of project planning, implementation, and evaluation
- Introducing and giving training for time-saving devices used for women's domestic tasks
- Providing opportunities for women to move from traditional roles or jobs to non-traditional roles or jobs
- Providing programs or activities to strengthen women's traditional roles, i.e., status, income, and social rewards
- Helping government, other development workers, and community people look at the role of gender in development
- Raising productivity of tasks performed by women
- Identifying and using local organizations traditionally supportive of women
- Researching, analyzing, and using data about women's role and status
- Sharing information and analyzing failures and successes of projects directed to women's needs
- Helping and educating other women and men in order to increase their understanding and support of gender in development

Total Time

Approximately 2 hours, 30 minutes



Overview

Melliferous plants and bees are the key components of any beekeeping venture. It is important to understand the plant-bee interaction, as well as the basic biology of the plant. This session provides participants with the background to explore the beekeeping potential of an area, recognize major bee-plant groups, and determine the various major plant sources of honey.

Objectives

- Explain basic floral anatomy
- Define pollination and cross-pollination
- Define the role of the bee in plant pollination
- List the characteristics of a good honey plant

Resources

- <http://www.beesfordevelopment.org>
- *Small Scale Beekeeping* [M0017]
- *Lessons Learned from Beekeeping in the Philippines* [R0032]
- *The Hive and the Honey Bee*, by Dadant and Sons
- *The Bee Keeper's Handbook*, by D. Sammataro and A. Avitabile

Materials

Hand lens, unlabeled schematic drawing of a flower, different examples of bee attractive plants (or pictures), and unlabeled schematic drawing

Session 19: Melliferous Plants

Procedures

Step 1: Floral Anatomy (30 minutes)

Distribute a flower to each participant. Have each participant examine his or her flower and identify the various anatomical structures. Explain and discuss the structures. Post the schematic drawing and have group members label the various floral structures.

Touch on the fact that the Leguminosae and Compositae plant families contain major bee-plants in most parts of the world. Discuss, using examples or pictures, the important characteristics that distinguish these families.

Trainer Note

Do not allow this step to become too academic. Allow the interests and needs of the group to determine the amount of detail necessary.

Step 2: Field Excursion (2 hours)

Direct a nature walk. Encourage the participants to observe, examine, and share their questions and observations with the group. While on the walk, have the participants:

- Collect, dissect, and identify floral structures, using a hand lens
- Define plant pollination and cross-pollination
- Examine the role of the bee in the pollinating process
- Identify bees collecting nectar and pollen
- Discuss factors that make flowers attractive to bees
- Outline the multipurpose use of plants
- Find and identify composites and legumes

Encourage interested participants to collect, examine, and identify plants used by bees throughout the training program and to share their observations with the group

Total Time

Approximately 2 hours



Overview

Honey is the primary product of the hive and the product with which consumers are most familiar. Quality, which is largely dependent on proper processing and careful marketing, is the main standard used by consumers to judge honey. In this session, participants will discuss uses, quality, storage, and the marketing of honey. Furthermore, they will examine methods appropriate to small-scale beekeepers for handling honey in order to maintain high quality. This information will equip the participants to better understand both the nature and the marketing of this product.

Objectives

- List various uses of honey
- Explain quality standards in honey
- List the physical and chemical properties of honey
- Explain methods of marketing honey
- List problems in storing honey
- Reflect on the ethics of carrying out beekeeping development programs in areas where honey is traditionally used solely for making alcoholic beverages

Resources

- <http://www.beesfordevelopment.org>
- *Small Scale Beekeeping* [M0017]
- *Lessons Learned from Beekeeping in the Philippines* [R0032]
- *The Hive and the Honey Bee*, by Dadant and Sons
- *The Bee Keeper's Handbook*, by D. Sammataro and A. Avitabile

Materials

Honey samples purchased by the participants on their site visits, heat source, a large pot, water, bread, or crackers

Session 20: Honey

Procedures

Step 1: Heating Honey (5 minutes)

At the start of the session, begin heating a sample of honey in a double boiler. Have a participant watch the sample. When the honey sample is close to boiling, have the participant take it off the heat so it may cool.

Retain an unheated portion of the sample. Tell the participants that at the end of the session they will be comparing the taste of heated and unheated honey.

Step 2: Historical and Traditional Uses of Honey (20 minutes)

Ask the participants to recount any local uses of honey that they have seen or heard about. Discuss the traditional uses of honey and relate these to local marketing possibilities. For participants who will be working in areas where honey is traditionally used to produce alcoholic beverages, address the ethical questions of stimulating increased honey production for this purpose.

Step 3: Marketing Honey (25 minutes)

Show samples of various ways to market honey. Discuss the advantages and disadvantages of each. Emphasize methods for local marketing for small-scale beekeepers. Point out that marketing is as important as producing in a beekeeping project.

Step 4: Physical and Chemical Properties of Honey (20 minutes)

Briefly discuss the conversion of nectar into honey. Discuss those physical and chemical properties of honey that affect its quality. Emphasize water content and explain that the only practical time to remove moisture from honey is before it is extracted.

Step 5: Quality in Honey (25 minutes)

Discuss quality standards as they relate to processing, storing, marketing, and using honey. Show honey samples, point out different quality honeys, and explain how quality is dependent on floral sources and processing methods. Ask the participants what factors they consider important in honey quality. During the discussion, address the following topics related to quality and marketing:

- Color
- Fermentation
- Crystallization

- Contamination by antibiotics
- Contamination by poisonous nectars
- Contamination by heat

Step 6: Tasting Honey (10 minutes)

Have the participants taste honey from various sources and compare the quality. Also have them compare the taste of the heated and unheated honey.

Figure 20-1: Removing Honey from Comb by Pressing

1. Harvest only comb containing honey.



2. Cut up the comb or squeeze with hands.



3. Strain through coarse strainer or screen wire.



4. Bottle and cap the honey.



Session 21: Other Hive Products

Total Time

Approximately 2 hours



Overview

Pollen, royal jelly, venom, proposes, and package bees are hive products. Their production requires intensive management techniques and their marketing is highly specialized. This session discusses the problems encountered by small-scale beekeepers in producing and marketing these products. It provides participants with an understanding of both the possibilities and the difficulties associated with producing these hive products.

Objectives

- Identify techniques and methods associated with the production, use, and marketing of hive products
- Discuss the problems of small-scale farmers in producing and marketing certain hive products
- Assess the relative cost of producing various hive products

Resources

- <http://www.beesfordevelopment.org>
- *Small Scale Beekeeping* [M0017]
- *Lessons Learned from Beekeeping in the Philippines* [R0032]
- *The Hive and the Honey Bee*, by Dedant and Sons
- *The Bee Keeper's Handbook*, by D. Sammataro and A. Avitabile

Materials

Newsprint, markers, nucs, pollen trap (or photos of pollen traps), and samples of hive products

Session 21: Other Hive Products

Procedures

Trainer Note

Prior to starting the session, prepare, on newsprint, the chart described in Step 2.

Step 1: Potential Products of a Bee Colony (1 hour)

Ask the participants to describe what they know or have heard about the methods used in producing royal jelly, venom, pollen, nucs, package bees, and propolis. Discuss these procedures and methods and point out the uses, potential value, and marketing techniques associated with these products. Focus the discussion on the problems involved in producing and marketing hive products for a small-scale beekeeper. Point out that for the small-scale beekeeper, propolis is easy to produce but marketing opportunities are limited. Demonstrate and pass around a pollen trap and other hive products.

Trainer Note

While bee brood is a hive product, its use is very restricted.

In some training situations, it may be worthwhile to make up a package of bees. If so, this can be incorporated into a Bee Management Techniques session.

Step 2: Relative Costs of Production (45 minutes)

Post the following chart with just the column titles:

Product	Labor Cost	Equipment Costs	Value in Relation to Extracted Honey
1. Venom	High	Medium	Very High
2.			
3.			
4.			
5.			

Session 21: Other Hive Products

Following the example, list other hive products and develop the chart with the participants. Encourage questions, analysis, and comments during this procedure. Emphasize that the chart is based on the value of other hive products in relation to extracted honey, which is the most common hive product.

Have two participants volunteer to facilitate **Session 24: Creamed Honey and Beeswax Products**.

Total Time

Approximately 2 hours

Overview

This session provides participants with the information they will need to design and conduct a community-based bee fair. The bee fair enables them to apply their new knowledge, attitudes, and skills in a manner that demonstrates a grasp of the philosophy and goals of the training program. It serves as an opportunity for the participants to draw together the major themes of the program and to integrate the varied learning experiences that they have gained. Participants are encouraged to work independently, in small groups, and with individuals from the local community. The participants take full responsibility for all aspects of planning, promoting, implementing, and evaluating the bee fair.

This final emphasis on the cumulative application of skills acquired during the program is designed to assist the participants in making the transition from the training environment to field service. It also serves to test participants' skill levels and to alert both them and training staff members to areas where improvement is needed.

Objectives

- Review and clarify the schedule and goals of the bee fair
- Review the guidelines for the bee fair
- Prepare for the bee fair

Resources

- <http://www.beesfordevelopment.org>
- *Small Scale Beekeeping* [M0017]
- *Lessons Learned from Beekeeping in the Philippines* [R0032]
- *The Hive and the Honey Bee*, by Dedant and Sons
- *The Bee Keeper's Handbook*, by D. Sammataro and A. Avitabile

Materials

Newsprint and markers

Session 22: Bee Fair

Procedures

Trainer Note

Prior to beginning this session, prepare on newsprint a large copy of the schedule for the remainder of the program (see Step 1).

Note that this session is designed to provide the information and procedures necessary to implement all aspects of the bee fair. This includes the introduction, preparation time, the fair itself, and the bee fair evaluation. These activities combined represent a total of 18 hours of scheduled training time as indicated on the six-week schedule.

Step 1: Goals and Schedule of Bee Fair (15 minutes)

Present a brief introduction to the purpose and general objectives of the bee fair. Explain that fairs are often important aspects of community life in developing countries. They provide an opportunity for people to gather, talk, and learn about new happenings or innovations. Point out that the basic purpose of the bee fair is to provide participants with the opportunity to creatively demonstrate beekeeping skills, as well as facilitation, communication, and extension skills acquired during the training program.

Post on newsprint a large copy of the schedule for the remainder of the program. Highlight and explain those activities related to the bee fair. Be sure to include preparation time, the day of the fair, and the bee fair evaluation. Explain that participants are expected to plan, promote, prepare, present, and evaluate all aspects of the bee fair.

Step 2: Guidelines (15 minutes)

Distribute Handout 21A Guidelines for Preparing for the Bee Fair. Review and carefully explain each of the guidelines. Answer any questions and clear up any confusion the participants may have. Emphasize that, from this point forward, the role of the staff will be to provide advice and guidance. Participants are expected to take full ownership and responsibility for the fair.

Step 3 Preparation for Bee Fair (1 hour, 30 minutes)

Allow the participants to use the time remaining in this session to prepare for the bee fair. Suggest that they appoint a facilitator and begin by brainstorming a list of the major task areas associated with the fair. Mention such areas as promotion, budget control, scheduling, setting up, music, games, and demonstration topics.

Trainer Note

Allow the participants considerable freedom and flexibility in their preparation time. Provide support where it is necessary. Monitor their efforts and help to keep them working within the guidelines outlined in the Handout.

Events and demonstration topics that can be used successfully in programs include:

- Honey tasting
- Langstroth equipment
- Bee beards
- Beeswax products
- Observation hive
- Creamed honey
- Honey extraction
- Apiary trips
- KTBH
- Bee brood as food

At some point, participants may need to go to the local market to purchase supplies for the fair.

As one aspect of their preparation activities, make sure the participants appoint a facilitator and design an approach for the bee fair evaluation.

Handout 22A: Guidelines for Preparing for a Bee Fair

- Everyone should participate fully in preparing for the fair.
- In keeping with the overall goal of providing the opportunity to creatively use skills acquired during the training program, the role of the training staff will be limited to providing guidance and advice. Everyone should have the opportunity to be responsible for all aspects of the fair.
- The fair should consist of a series of method demonstrations and/or activities related to beekeeping that would be of interest to the surrounding community.
- Each of you will be responsible for preparing and presenting at least one method demonstration on the day of the fair.
- The fair should be designed to last 4–6 hours.
- Throughout the activities of the fair, there should be an emphasis on the integration of the themes presented during the training program.
- Everyone will be responsible for food, fuel, water, and other necessary materials or supplies.
- Information should be available to all guests and community members.
- Music, games, and food should be an integral part of the fair.
- A schedule of events should be developed and made available to all participants and guests.
- Following the fair, the group will be responsible for designing and implementing a structured evaluation of the effectiveness of the fair.

Total Time

Approximately 4 hours

Overview

Beeswax has many commercial uses. An understanding of the commercial potential of beeswax enhances one's knowledge concerning the marketing and the value of this hive product. This session provides participants with the opportunity to observe both a use of beeswax and a local business. It provides technical information while giving participants a chance to develop cross-cultural skills.

Objectives

- Observe a commercial use for beeswax
- Observe a local business
- Observe a traditional craft that uses beeswax (Africa)
- Interact with a commercial supplier of the local beekeeping industry

Resources

- <http://www.beesfordevelopment.org>
- *Small Scale Beekeeping* [M0017]
- *Lessons Learned from Beekeeping in the Philippines* [R0032]
- *The Hive and the Honey Bee*, by Dedant and Sons
- *The Bee Keeper's Handbook*, by D. Sammataro and A. Avitabile

Procedures

Trainer Note

This session requires considerable advance preparation. Arrangements include: locating the shop to be visited, discussing details with the proprietor, and obtaining transportation.

In the African region, a trip to a cloth batik shop, or to a lost-wax metal casting shop, may be possible. In the Inter-American region, a trip to a shop where comb foundation is made is suggested.

Session 23: Beeswax Field Trip

Step 1: Field Trip (4 hours)

Take a field trip to observe a commercial use for beeswax. While en route, discuss with participants the objectives for this field trip and how to best meet these objectives.

Once at the destination, assist the participants in interviewing the proprietor of the operation. The following are points to consider:

- Source of the beeswax used
- Quality standards and control
- Procedures used
- Cost of materials
- Markets available for products
- Problems in marketing
- Price of finished products

After leaving, review the following with the participants:

- Important technical insights
- Important cross-cultural insights
- Conditions that were observed that might limit beekeeping/agricultural development

Session 24: Creamed Honey and Beeswax Products

Total Time

Approximately 4 hours

Overview

Producing creamed honey is a simple and inexpensive process that greatly increases the market value of honey. This session acquaints participants with this product and gives them experience in making it.

Beeswax is a high-value hive product. In some situations, its value is unrecognized, while in other situations poor handling and processing techniques often lead to income lost by the beekeeper. This session explores the handling, processing, and marketing of beeswax and beeswax products. The participants gain experience in making beeswax products and learning more about quality standards.

Objectives

- Prepare creamed honey
- List the uses and marketing of beeswax
- Define quality standards for beeswax
- Prepare beeswax for market
- Process and store beeswax
- Prepare beeswax products

Resources

- <http://www.beesfordevelopment.org>
- *Small Scale Beekeeping* [M0017]
- *Lessons Learned from Beekeeping in the Philippines* [R0032]
- *The Hive and the Honey Bee*, by Dadant and Sons
- *The Bee Keeper's Handbook*, by D. Sammataro and A. Avitabile

Session 24: Creamed Honey and Beeswax Products

Materials

Cheese cloth, previously extracted honey, finely crystallized honey, cooking thermometer, funnel, towels, cooking pots, largemouth jars, old comb, enamel or aluminum pot (size depends on amount of comb to be rendered), fuel for fire, screen wire strainer, knife, water, burlap bag, rocks, stirring stick, ingredients to make beeswax products, and containers (the ingredients and type of containers depend upon that products will be made)

Procedures

Step 1: Preparing Creamed Honey and Beeswax Products (4 hours)

Have the participants who previously volunteered to facilitate these activities in Session 22. Other Hive Products take charge. The activities should include:

- Making creamed honey
- Rendering old comb by different methods
- Making various beeswax products. Beeswax furniture/wood polish and beeswax cold cream are good choices since they are simple to make and the ingredients are readily available in most areas.

Move among the participants and offer suggestions and encouragement. Remember to give the participants the freedom to experiment. Point out that beeswax should not be allowed to boil. Remind participants of the fire danger in working with liquid beeswax.

Facilitate discussions on the uses, quality standards, and marketing of these products.

Trainer Note

There will be a number of activities going on at the same time during this session. While it is not important that each participant participate directly in each activity, it is important that everyone see and understand the processes involved in all of the activities.

These activities are also very amenable to being included in the bee fair. Any participants who would like to have more time to make creamed honey or beeswax products can prepare samples for the bee fair.

Total Time

Approximately 2 hours



Overview

The recognition and control of bee diseases and pests is an integral part of beekeeping. This session explores the causes and symptoms of bee diseases, common pests of bees, and the control of these diseases and pests. Participants will discuss disease and pest problems in bee colonies and will examine practical approaches for helping small-scale beekeepers recognize, prevent, and eradicate these colony problems.

Objectives

- List the causes of bee diseases
- Cite the symptoms of major bee diseases
- Cite methods of controlling diseases and pests
- Examine samples of healthy brood comb

Resources

- <http://www.beesfordevelopment.org>
- *Small Scale Beekeeping* [M0017]
- *Lessons Learned from Beekeeping in the Philippines* [R0032]
- *The Hive and the Honey Bee*, by Dadant and Sons
- *The Bee Keeper's Handbook*, by D. Sammataro and A. Avitabile

Materials

Pictures of honey bee diseases and pests (or slides), empty comb, brood boxes, newspaper, flour paste, sulfur, alcohol, matches, jar lids, and sugar.

Session 25: Bee Diseases and Pests

Procedures

Step 1: Causes and Symptoms of Bee Diseases (45 minutes)

Discuss the causes and symptoms of bee diseases. Have the participants develop a list or chart of diseases from pictures in the book (and/or from slides). Ask them to compare the symptoms of the diseases and make a diagnosis of each. Demonstrate healthy brood and review how to distinguish this situation from diseased brood.

Step 2: Control of Diseases (45 minutes)

Have participants brainstorm a list of potential problems of effective bee disease control among small-scale farmers. Include the problems of disease recognition/ differentiation and access to treatment. Recall any specific examples or instances that may have been observed during visits to beekeepers.

Emphasize that treatment for brood diseases differs from that of adult diseases; also, that antibiotics are only effective in treating those diseases caused by bacteria. Discuss and demonstrate methods of honey bee disease control. Be sure to include how beekeepers can sanitize their clothing and equipment to prevent the spread of diseases. Explain how to differentiate starvation from disease symptoms. Remind participants of the possibility of mailing diseased samples to laboratories to verify field diagnoses.

Step 3: Recognition and Control of Honey Bee Pests (15 minutes)

Use photographs and samples of infested comb to demonstrate honey bee pests. Discuss and demonstrate methods of pest control. Include the storing of drawn comb to prevent wax moth damage.

Total Time

Approximately 2 hours



Trainer Note

This could be an optional session for Volunteers who are working with farmers who are beekeeping in communities where pesticides are being applied.

Overview

Insecticides kill bees. The proper application of the appropriate insecticide will minimize the damage done to nearby bee colonies. At times, the beekeeper will need to educate neighboring farmers about insecticides and their negative impact on the bee colony.

A Peace Corps Volunteer is often viewed as a resource for the community. As such, familiarity with insecticides and their use and misuse or knowing someone with that experience is important if the Volunteer is to provide good advice. In this session, participants recognize the impact pesticide use can have on bee colonies.

Objectives

- Examine problems and abuses common to pesticide use
- Recognize and describe the symptoms of pesticide poisoning in bees
- List socio-economic factors that influence pesticide selection in developing countries
- Describe techniques for proper application of pesticides to reduce damage to bee colonies
- Identify local resources for educating on the proper application of pesticides

Resources

- <http://www.beesfordevelopment.org>
- *Small Scale Beekeeping* [M0017]
- *Lessons Learned from Beekeeping in the Philippines* [R0032]
- *The Hive and the Honey Bee*, by Dedant and Sons
- *The Bee Keeper's Handbook*, by D. Sammataro and A. Avitabile

Session 26: Insecticides and Bees

Materials

Blackboard, chalk, live bees in small containers, examples of pesticides

Procedures

Step 1: Insecticide Use and Misuse (25 minutes)

Examine the problems and abuses common to pesticide usage in developing countries. As the basis for this discussion, have the participants describe any problems or abuses they have seen in the community's training site or in the United States.

Step 2: Symptoms of Pesticide Problems (25 minutes)

Apply a variety of pesticides to samples of bees in small glass jars. Pass the jars around among the participants. As the pesticides begin to affect the bees, have participants describe the symptoms they see. Write their responses on newsprint. Discuss the symptoms in detail and explain how they may easily be confused with other problems in the colony.

Step 3: Pesticide Selection (25 minutes)

Ask the participants to generate a list of socioeconomic factors involved in selecting a pesticide in developing countries. Write the list on newsprint. Stimulate responses and provide focus by suggesting such factors as:

- Directions written in English in a non-English speaking country
- The selling of a pesticide outlawed or regulated in the country where it is manufactured
- The selection of a pesticide due to cost, rather than the pest to be eradicated
- The selection of a pesticide used successfully in the past, even though a safer one has been developed

Step 4: Pesticide Application (30 minutes)

Discuss the proper way to apply pesticides to minimize damage to bees. Ask participants to describe techniques for applying pesticides if they have experience in doing so. Discuss what precautions need to be taken from the point of view of the applicator, as well as for the bee colonies.

Session 26: Insecticides and Bees

Present participants with different scenarios and have them respond as a group with their solutions to each problem. For each scenario, have them identify the potential problem or danger; describe the cause of the problem; and explain the steps necessary to correct it.

Trainer Note

Some potential scenarios include: (a) applying insecticides on the ground around the colony to control ants; (b) spraying a wealthy farmer's fields that are upwind from a poor farmer; or (c) spraying repeatedly a long-blooming, highly bee-attractive crop (such as cotton).

Resources

Title	Description
Bee Culture	Online magazine of American beekeeping
Bees For Development	This is a really important resource for those doing work with honey bees in the context of development. They also publish the journal, Bees for Development, and are particularly focused on bee health and sustainability as a measure of success. There are many articles on beekeeping in relation to appropriate technologies, which makes it an unparalleled resource for PCVs.
Beesource	Beesource.com has over 14,000 registered members and is the most active online beekeeping community of its kind in the world.
Certified Naturally Grown	To support natural beekeepers everywhere, they publish two online booklets: Handbook for Natural Beekeepers based on our Apiary Certification Standards, and Help the Honey Speak A Marketing Guide for Beekeepers with Naturally Managed Apiaries.
CIFOR	They have some materials on beekeeping in relation to community forestry.
Manual de Apicultura Basica	Online guide to beekeeping in Spanish.
Manual de Apicultura Organica	Online guide to organic beekeeping in Spanish.
Prácticas de apicultura	Online guide to beekeeping in Spanish.
Scientific Commission Beekeeping for Rural Development	The mission of the Apimondia Standing Commission for Beekeeping for Rural Development is to provide a forum for sharing information on how apiculture contributes to the development of sustainable livelihoods, worldwide.

KTBH Plans

How to Build a
Kenya Style

Top Bar Hive (KTBH)

Materials

- 2 - 1" x 12" x 46 1/2"
- 2 - 1" x 12" x 15"
- 1 - 1" x 6" x 46 1/2"
- Any kind of lid 15" x 48"
- 16- bars 15" x 1 1/4" x 3/4"
- 18- bars 15" x 1 1/2" x 3/4"
- 34- triangular comb guides 1" x 3/4" x 13"

Bars should fit snugly together with no spaces.

Bee Entrance

Lid/Cover

Appendix A: Hive Plans

Langstroth Hive

Construction plans for a
Ten Frame

Langstroth BeeHive

Construction details for 3/4" thick lumber

The species of wood used to make a beehive can vary depending upon what is available in your area. The minimum thickness should not be less than 3/4". If you are using standard dimensional lumber, you can use 1x8 (3/4" x 7 1/4") for both shallow and medium super, and 1x12 (3/4" x 11 1/4") for the hive body.

Start by cutting the boards to length. For fronts and backs, cut them just over 16 1/4". For sides, cut a smidgen over 19 7/8". Cut box joints.

Now that you have the joint cut and the boards cut to finished size, cut the 5/8" x 3/8" board rabbet on the 16 1/4" boards, stopping just short of the box joint pin at each end. (Chisel these squares after the boards are assembled.) Note: pre-drill nails for holes in each pin.

Assemble boxes with glue and nail each pin with a 6d galvanized nail. Attach 1x2" hand holds with screws and glue. Attach metal rabbets on the frame rest notch. Fill holes and paint all surfaces, top and bottom, inside and out with two coats of paint.

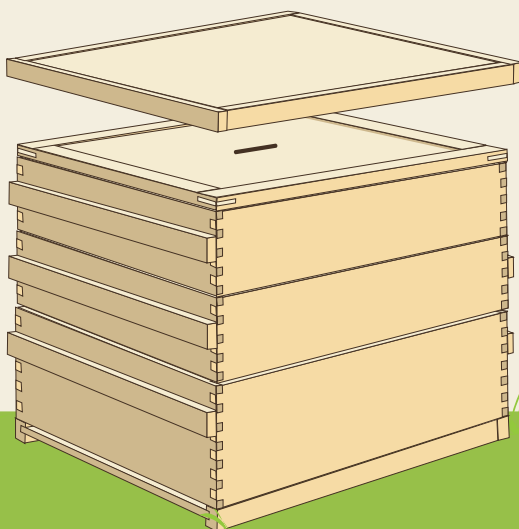
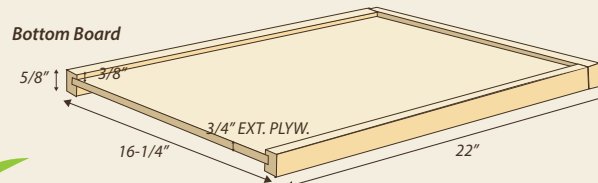
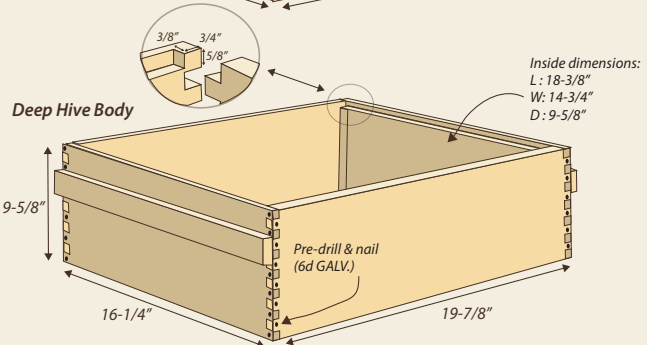
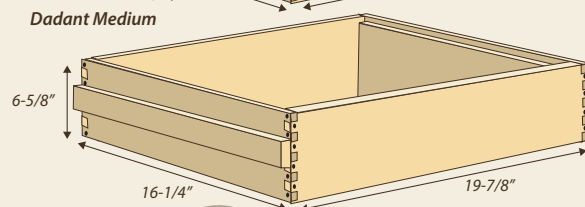
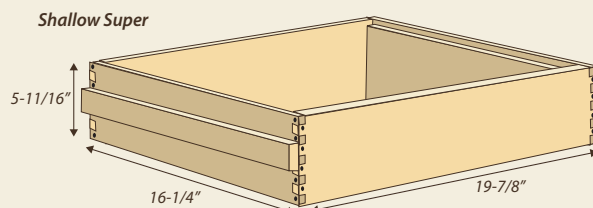
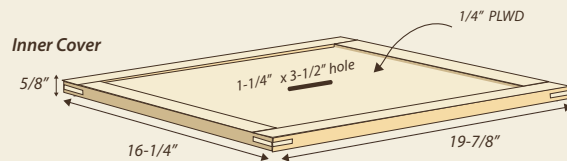
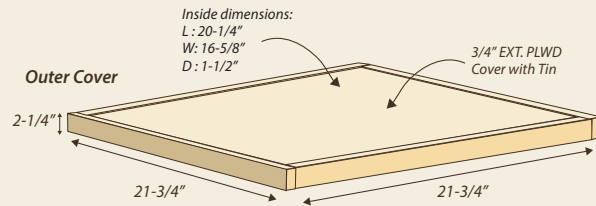
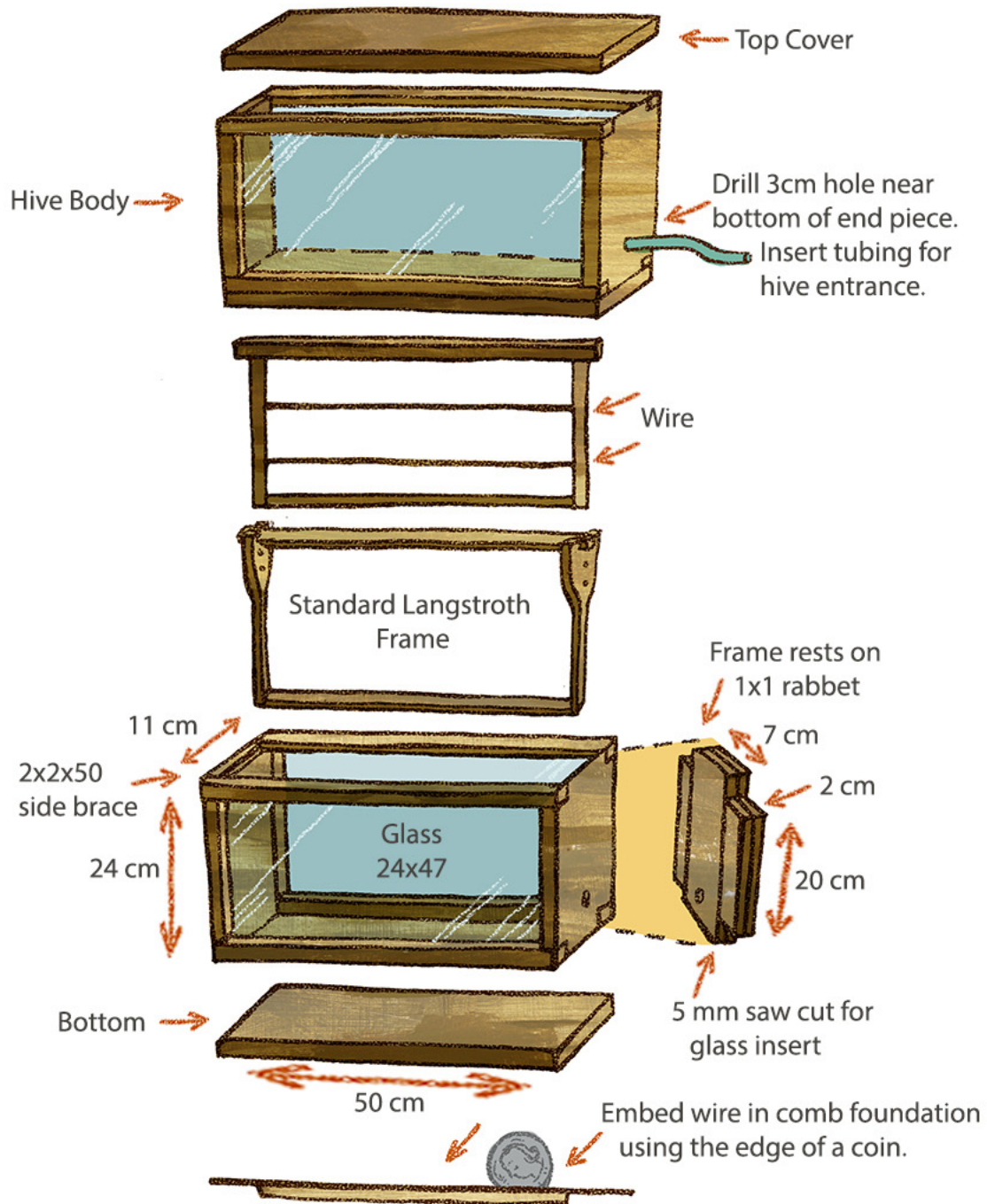

Illustration by: Kelly Bigelow Becerra

Observation Hive

The observation hive body (based on 1.9 centimeter lumber; all measurements in centimeters) can be covered with cap of same dimensions as the bottom, or several hive bodies can be stacked. Remember to leave a bee space around the frame. Wire is used in frames to reinforce them.



Appendix B: Equipment Plans

Honey Extractor

Cut off the cell-cappings before extracting the frame of honey. Partially extract the honey from one side of the comb; then turn the frame around and completely extract the other side. Turn the frame around again and finish extracting the comb. This minimizes comb breakage by preventing the weight of the full side of the frame of honey from pressing against the empty side.

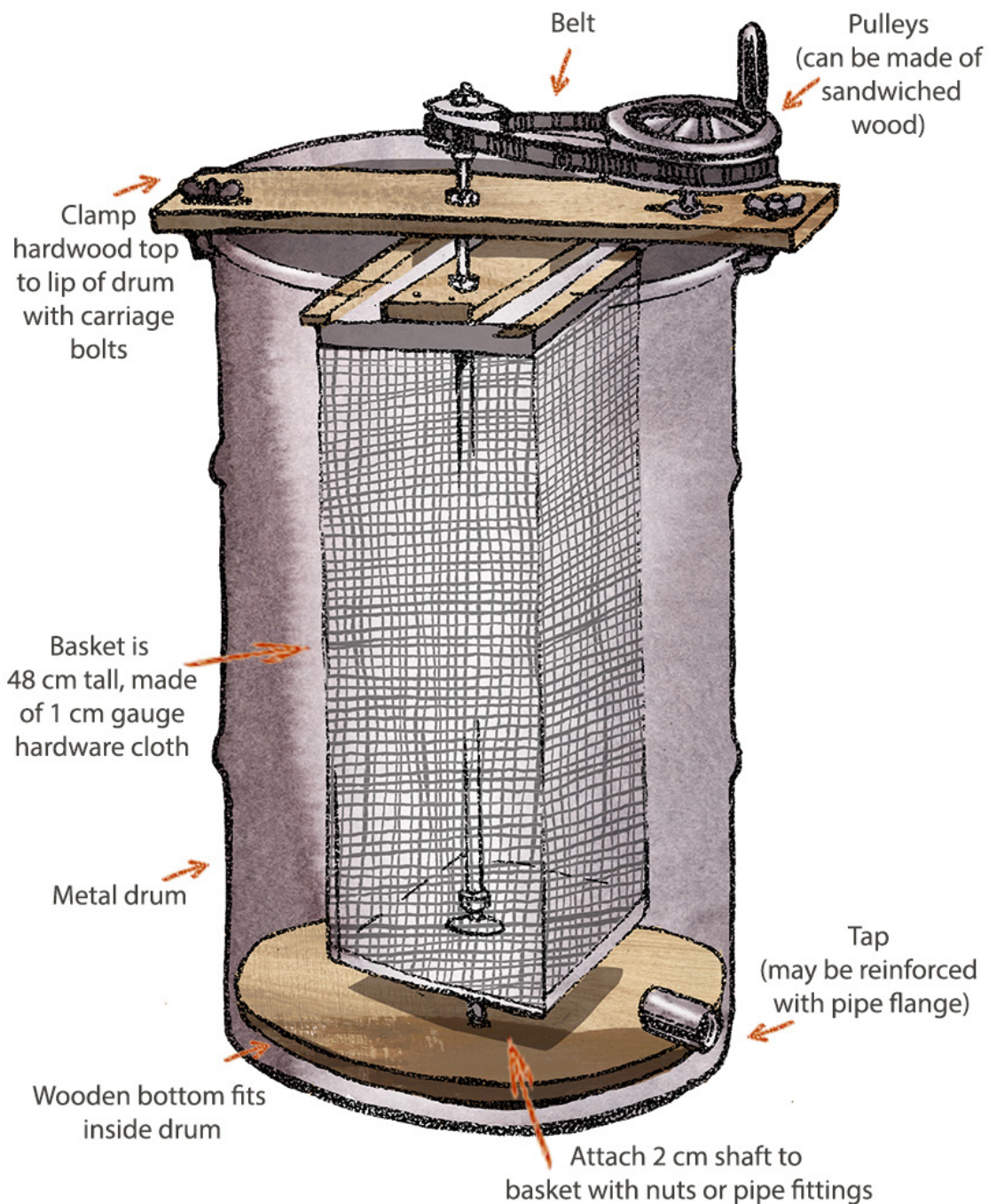

Appendix B: Equipment Plans

Basket Details

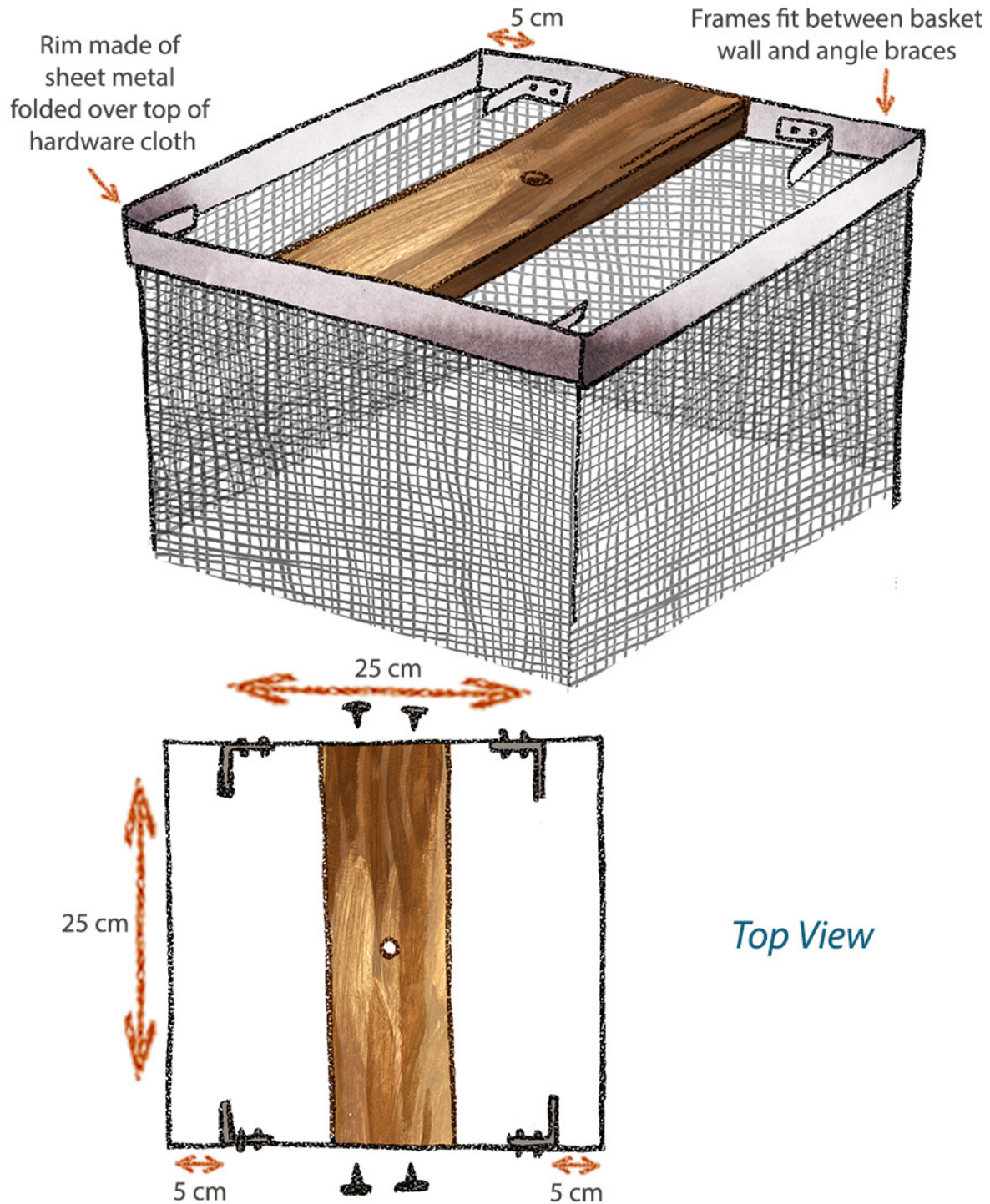

Appendix B: Equipment Plans

Handheld Honey Extractor

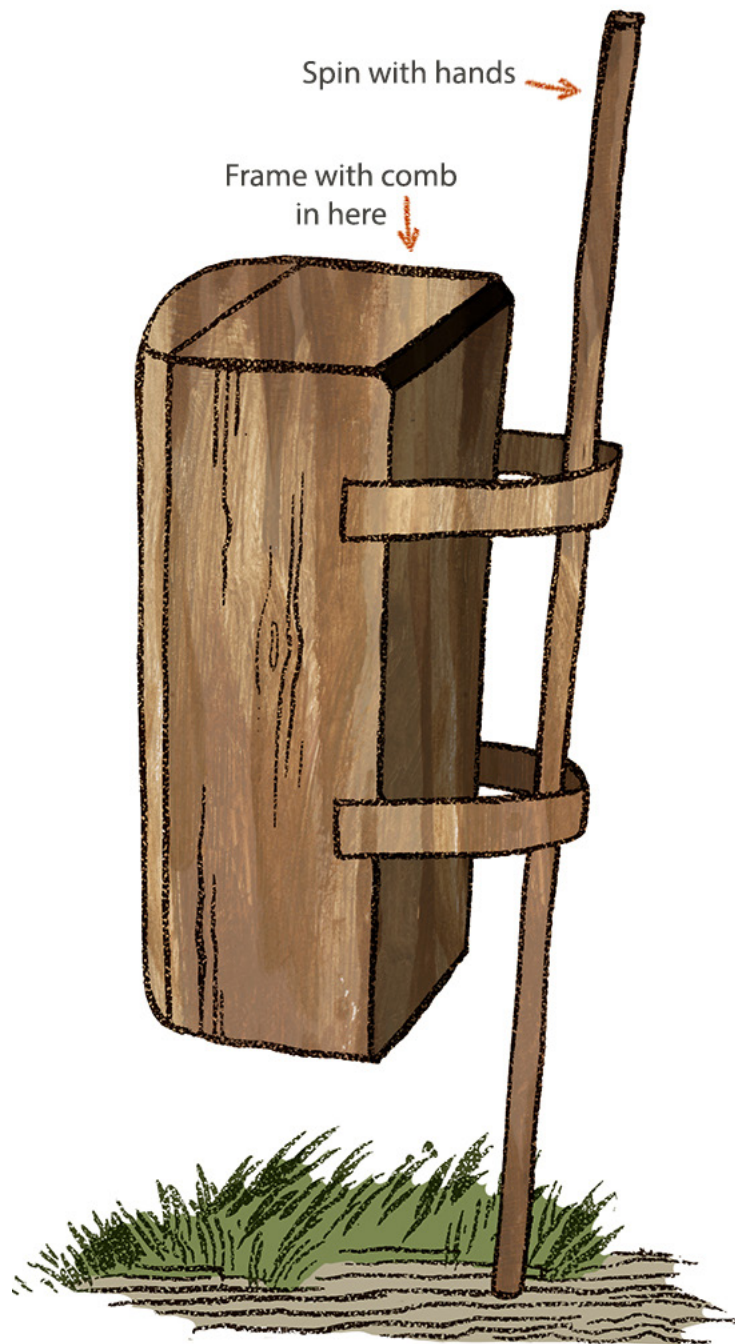

Smoker

How to Build a

Beehive Smoker

Fire Chamber

Large can braced with wooden can wedge placed inside, use nails to form a circle, use hammer to punch through center.

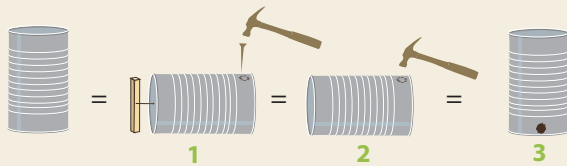

Smoker Cap

Large can braced with wooden can wedge placed inside, use nails to form a circle of holes, use hammer to punch through center. Cut a line in can so that it will fit inside fire chamber

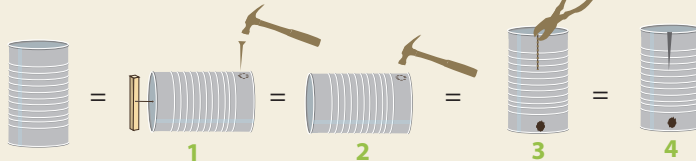

Grate

Small can, cut off bottom section, *save remaining upper can for attaching bellows to fire chamber. Use nails to punch holes in can bottom, Cut sides to form legs, *save remaining strips for hinges on bellows, and insert grate into fire chamber (hole should be below grate).

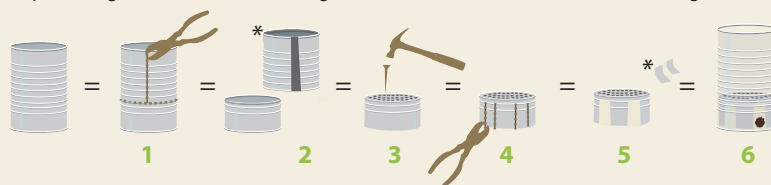

Bellows

Two boards, drill hole in center bottom of board A (hole should be slightly smaller than fire chamber hole). *use remaining strips of small can for hinges, attach hinges to board (A), then to board (B) as shown. Open boards and cover with plastic, use a small twig and staples to secure plastic to bellows (airtight and on all sides).

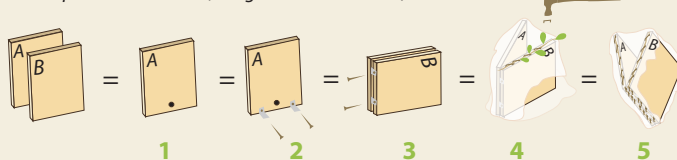

Please Note:

If you can easily purchase a smoker, please do so. A purchased smoker is likely to be safer and more effective.

*Smoker Cap is VERY HOT - use caution when removing.

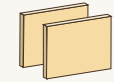

Illustration by: Kelly Bigelow Becerra

Materials and Tools



- Requires 3 steel cans – 2 of same size, 1 slightly smaller in diameter (no aluminium cans – they can't take the heat)



- Plastic or leather for bellows
- Wood planks for bellows - approx 6"x8"x 1/2"



- Staples/wire/nails to affix plastic to bellows
- Screws (could use wire instead)



- Hammer or a good rock
- Tin snips or a hacksaw or a sharp machete
- Nail to poke holes in cans
- Wooden can-wedge - diameter of the larger can (This is used to brace a can from being crushed when nailing a hole thru it.)



- Screwdriver (if using screws)
- Pliers (optional)

Attaching Bellows to Fire Chamber

Use remaining top of small can, use nail to poke three holes in back of can to screw into bellows board (A), use nail to poke 2 holes in each side to attach to fire chamber. Be sure to line up Bellow hole with fire chamber hole. *2 inch gap is ideal between these holes to avoid hot ash being sucked into the bellows

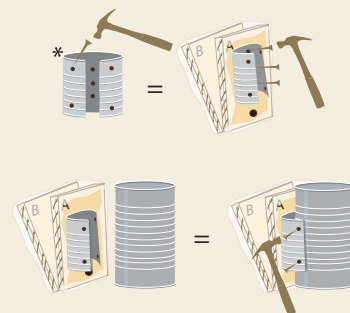

Finished Smoker



Appendix B: Equipment Plans

Wetting Liquid

Use a mixture of rainwater or distilled water, detergent, honey, and alcohol. The mixture should not be bubbly.

NOTE: Minerals in the water will cause the wax to stick.

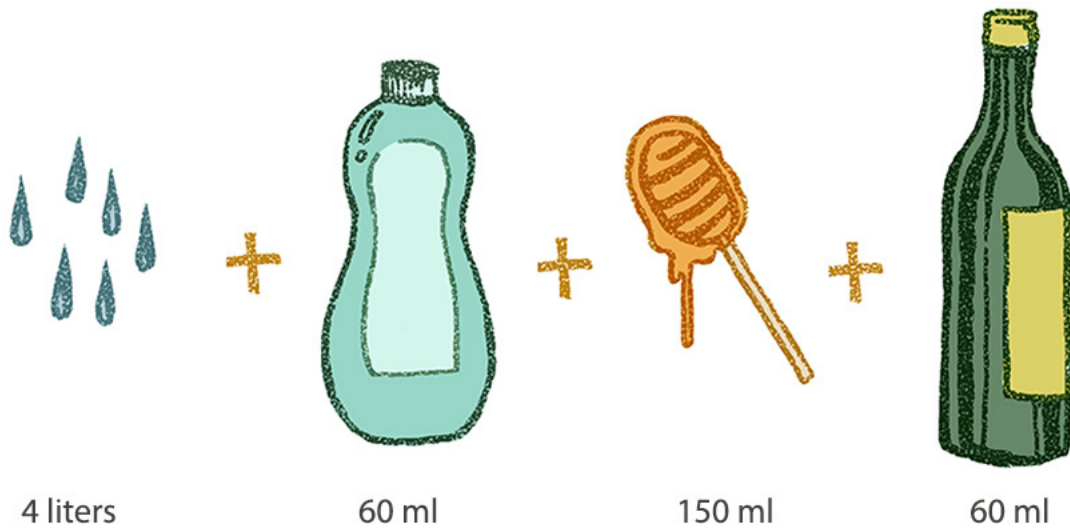

Making Starter Strips with a Dip Board

1. Use a smooth hardwood board.



2. Wet the board with wetting liquid.



3. Dip the board into hot wax.
For thicker strips, dip board several times.



4. When wax hardens, peel it from the board, trim it, and cut it into 2 centimeter strips.



Appendix B: Equipment Plans

A Mold for Making Wax Foundation

1. Put frame containing a sheet on foundation board.



2. Coat foundation with vegetable oil.



3. Pour in plaster of Paris and allow to harden.

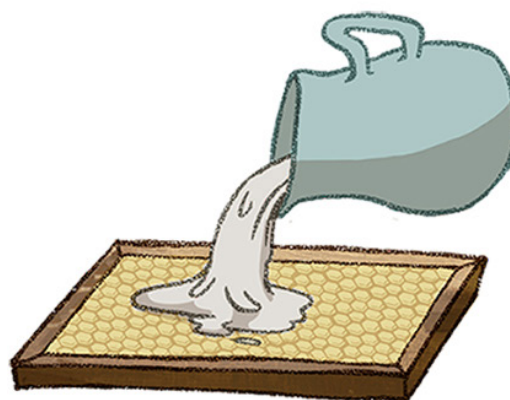

4. Turn over and repeat for the other side.

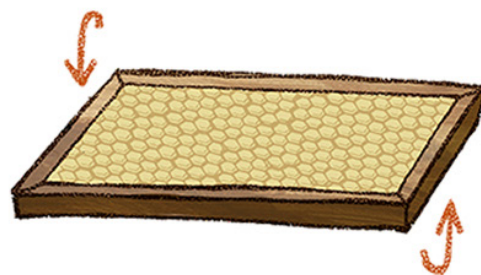

5. When molds are solid, carefully separate them. Build a hinged frame (box) to hold the molds.

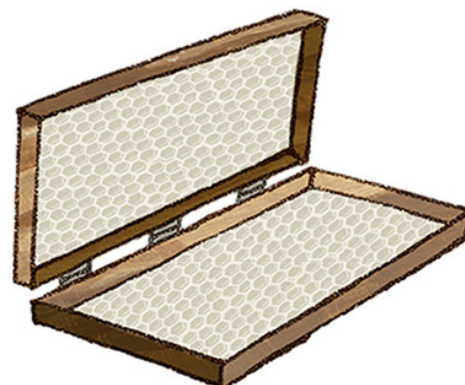

Making Foundation

1. Brush the mold with wetting liquid.



2. Pour melted wax in the center of mold.



3. Remove wax sheet, rinse it off with cool water, and trim it.

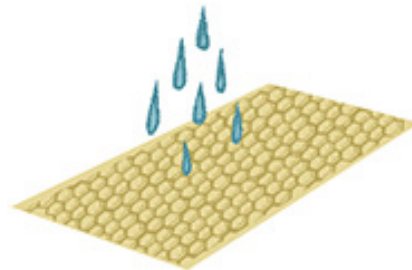

NOTE: Melt the wax in a double boiler. Wax is flammable. Do not allow wax to boil; this will make it brittle.